



for a greener tomorrow



**MITSUBISHI
ELECTRIC**

Changes for the Better

FACTORY AUTOMATION

MELSEC iQ-F Series iQ Platform-compatible PLC



The next level of industry

MELSEC iQ-F
series

GLOBAL IMPACT OF MITSUBISHI ELECTRIC



Through Mitsubishi Electric's vision, "Changes for the Better" are possible for a brighter future.

Changes for the Better

We bring together the best minds to create the best technologies. At Mitsubishi Electric, we understand that technology is the driving force of change in our lives. By bringing greater comfort to daily life, maximizing the efficiency of businesses and keeping things running across society, we integrate technology and innovation to bring changes for the better.

Mitsubishi Electric is involved in many areas including the following

Energy and Electric Systems

A wide range of power and electrical products from generators to large-scale displays.

Electronic Devices

A wide portfolio of cutting-edge semiconductor devices for systems and products.

Home Appliance

Dependable consumer products like air conditioners and home entertainment systems.

Information and Communication Systems

Commercial and consumer-centric equipment, products and systems.

Industrial Automation Systems

Maximizing productivity and efficiency with cutting-edge automation technology.

OVERVIEW

Concept	4
Function introduction	8
System Configuration	36
Performance Specifications	40
New products	41
Lineup details/model selection	44
I/O Module	57
Analog control	65
High speed counter	77
Pulse output/positioning	81
Network/Communication	91
Programming/Development Environment	119
Option/Related Products	123
Overseas service system/compatible products	131
Specifications	135
Products list	185

iQ Platform

“Connect” Factory Automation with iQ Platform

“iQ Platform”, a solution that integrates and cooperates with controllers, HMI, engineering environments, and networks at the production site, Mitsubishi Electric has proposed along with “e-F@ctory” that information-links the high-level information system (manufacturing execution system (MES)) and production site, will integrate and optimize your system with advanced technology to reduce development, production and maintenance costs.

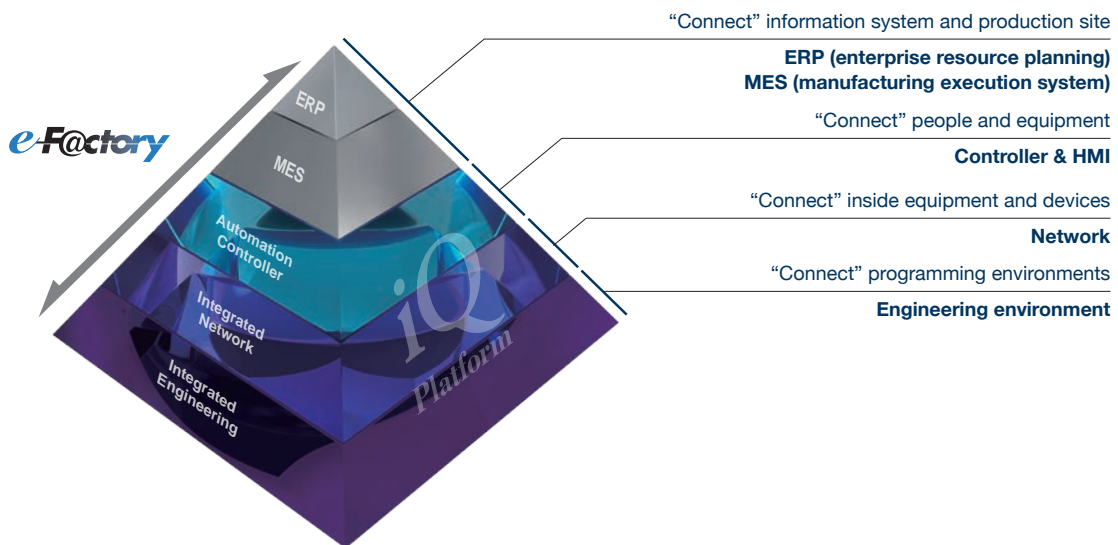

Fundamentally Solving FA’s Task from the Viewpoint of TCO

Controller & HMI

Improving productivity and product quality

1. Significant improvement in total system performance due to high-speed MELSEC series system bus performance
2. Equipped with dedicated memory for FB*1/ label required for program standardization
3. Integrated, enhanced security function

Network

Loss reduction with high precision and production speed

1. Possible to connect to, without loss, 1 Gbps high-speed communication realized by CC-Link IE Field Network
2. Realizing seamless communication of various devices using SLMP*2

Engineering environment

Efficient development, operation, and maintenance

1. Possible to detect and generate a large-scale network configuration diagram from the actual machine
2. Realized mutual reflection of parameters between MELSOFT Navigator and each engineering software
3. Automatically following device change of system labels held commonly between each controller and HMI

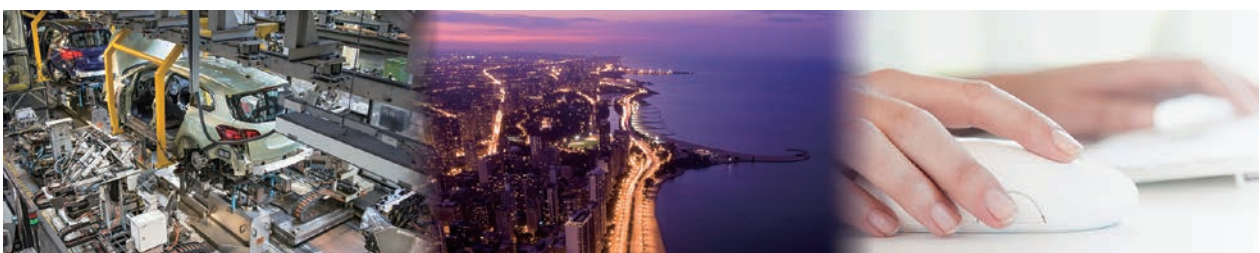

*1: Function Block

*2: SeamLess Message Protocol

MELSEC

The MELSEC series offer optimum automation control with a wide variety of products from compact systems to plant scale systems. Series specialized for specific functions to meet all the needs of the production site are also provided.

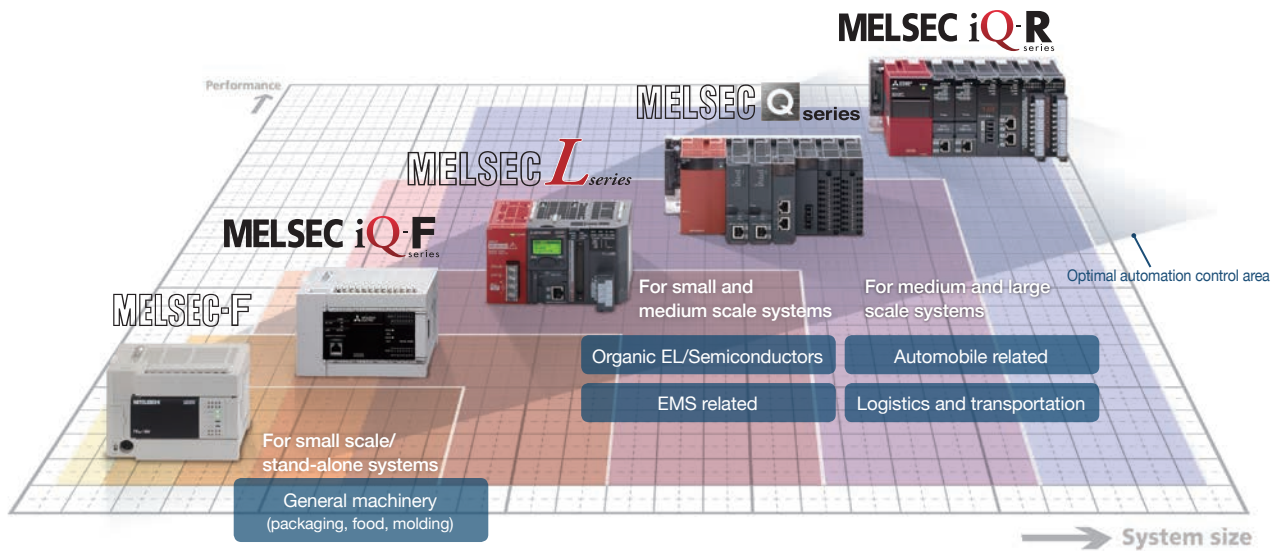

For small scale/standalone systems



MELSEC-F series

Abundant functions and extendability housed in a compact body. All-in-one PLC with power supply, CPU, and I/O. Responds to various needs by connecting a wide variety of extension equipment.



MELSEC iQ-F series

Next-generation micro PLC that can support high speed of the system bus, enhanced built-in functions, and varieties of networks. A system from stand-alone to network use can be proposed, to strongly support the customer to "go one step ahead in manufacturing".

For small and medium scale systems



MELSEC-L series

Space inside the control panel saved by adopting a baseless structure. Condensed the function, performance, and operability required by the site into a compact body, realizing easy-to-use and more versatile control.

For medium and large scale systems



MELSEC-Q series

Realized high speed control by parallel processing using the multi-CPU function, improving the performance of customer's equipment and machine.



MELSEC iQ-R series

An innovative next-generation controller that opens a new era of automation. Realized a substantial reduction in takt time with a newly developed high-speed system bus mounted.

MELSEC iQ-F series

Designed on the concepts of outstanding performance, superior drive control and user centric programming, Mitsubishi's MELSEC-F series has been reborn as the MELSEC iQ-F series.



From stand-alone use to networked system applications, MELSEC iQ-F series brings your business to the next level of industry.



Function and cost performance required for small-scale/stand-alone control



Built-in functions

Even easier to use with the fulfilling built-in functions. Supports the customer to “go one step ahead in manufacturing”.

For details, go to P8.



Analog control

Analog control suitable for the application is possible by using expansion modules in addition to the analog input/output function of the CPU module.

For details, go to P14.



Positioning control

Not only built-in positioning but full positioning is also possible by extension modules.

For details, go to P18.

Design concept of micro PLC

Performance

Outstanding performance

- High-speed system bus
- Extensive built-in functions
- Enhanced security functions
- Battery-less

Affinity

Cooperation with driving equipment

- Easy built-in positioning (4-axis 200 kpps)
- Simple interpolation functions
- 4/8-axis synchronization control (no special software required) by simple motion module

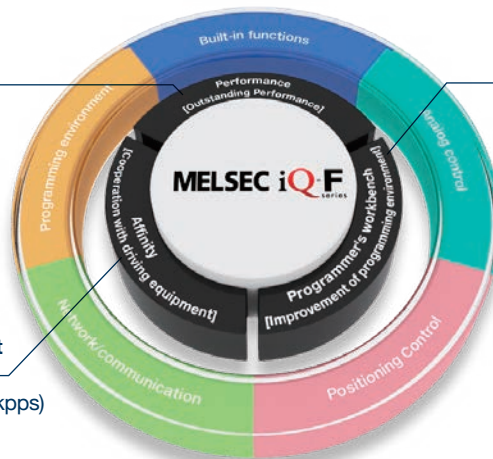

Programmer's workbench

Improvement of programming environment

- Easy programming by drag and drop
- Reduced development time with module FB
- Parameterized setup for a variety of functions



Network/ communication

Supports the network of AnyWireASLINK system as well as CC-Link IE Field Network and CC-Link V2.

For details, go to P22.



Programming environment

Realized graphical intuitive operability, and easy programming by just "selecting".

For details, go to P30.



Built-in functions

The CPU module has excellent built-in functions to respond to various types of control. Ethernet port, RS-485 port, and SD memory card slot are standard equipment. The Ethernet port is compatible with CC-Link IE Field Network Basic and can be connected to a wide variety of equipment.

FX5U



CPU Performance

The MELSEC iQ-F series has a CPU capable of high-speed processing with an instruction operation speed (LD instruction) of 34 ns*2. In addition, the CPU supports execution of structured programs and multiple programs, ST language, FB etc.



Program capacity 64 k/128 k*1 Steps	Instruction execution speed (LD, MOV instruction) 34 ns*2
PC MIX value 14.6 instructions/μs	Fixed Cycle Interrupt Program Min. 1 ms

High-speed System Bus Communication

With the high-speed CPU, the MELSEC iQ-F series realizes high-speed system bus communication of 1.5 K words/ms (about 150 times compared to FX3U), and can deliver to its full potential when using an intelligent function module handling a large amount of communication data.

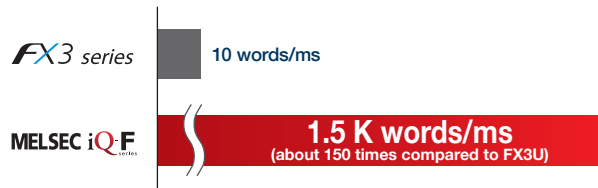

Built-in Analog Input/Output (with alarm output)

The FX5U has built-in 12-bit 2-channel analog voltage input and 1-channel analog voltage output.



Battery-less and Maintenance-free

In the MELSEC iQ-F series, programs and devices are held in a battery-less*3 memory such as flash ROM.

*1: Supported by FX5U/FX5UC Ver. 1.100 or later, and product number 17X**** (product number 178**** for FX5UC-32MT/DS-TS and FX5UC-32MT/DSS-TS) or later. Some operation restrictions apply when 128 k steps is selected. For details, refer to the manual.

*2: When the program capacity is 64 k steps.

*3: Using an optional battery can increase the capacity of the device.

FX5UC

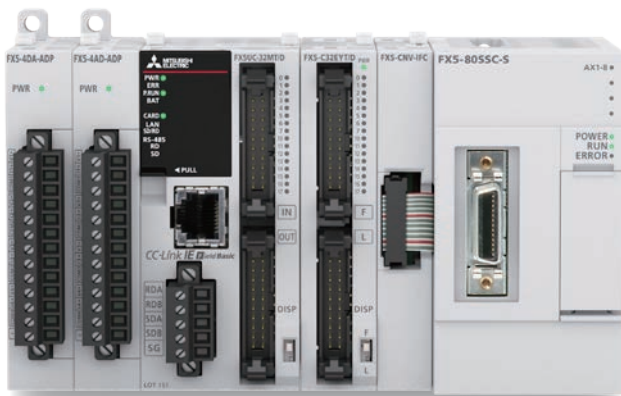

Connector type



Spring clamp terminal block type

Built-in Ethernet Port

The Ethernet communication port can handle communication of up to 8 connections on the network, and can support multiple connections with personal computer and other devices. In addition, the Ethernet communication port can handle seamless SLMP communication with the upper-level device.

The CPU module and engineering tool (GX Works3) can be directly connected with a single Ethernet cable. Each device can be set easily with parameters.



Built-in SD Memory Card Slot

A built-in SD memory card slot is convenient for updating the program and mass production of equipment. Data can be logged*1 in SD memory card, making it easy to analyze the system status and production state, etc.

>> Data logging function

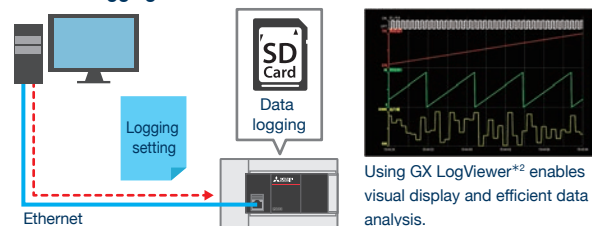

Built-in RS-485 port (with MODBUS function)

Connect to serial devices up to 50 m away with built-in RS-485 port. Control for up to 16 Mitsubishi electric inverters is possible with dedicated inverter communication instructions.

MODBUS is also supported and can connect up to 32 MODBUS devices such as PLCs, sensors and temperature controllers.



RUN/STOP/RESET Switch

RUN/STOP/RESET switch is built in. PLC can be rebooted without turning off the main power for efficient debugging.



*1: Supported by FX5U/FX5UC Ver. 1.040 or later and product number 16Y*** or later, by GX Works3 Ver. 1.030G or later, and by CPU Module Logging Configuration Tool Ver. 1.64S or later.

*2: Supported by GX LogViewer Ver. 1.64S or later.

Function introduction



Built-in functions



Logging Section

YouTube
MITSUBISHI ELECTRIC
Factory Automation
MELSEC iQ-F Technical Video

Memory area for each application

The program memory capacity of the MELSEC iQ-F series has 64 k/128 k steps*3, and the memory data area is reserved for each application, so all 64 k/128 k steps*3 can be used as the program area. Therefore, comments and statements can be written without being aware of conflicts within the area.

[Maximum number of characters]

Comment: 1024 characters Statement: 5000 characters

MELSEC iQ-F series stores the program and devices in non-volatile memory such as Flash ROM, so no battery is required.

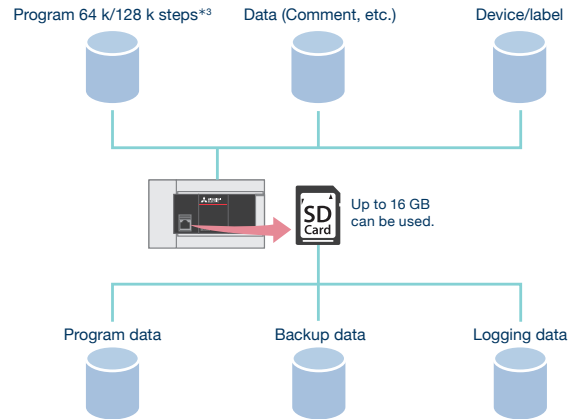

Data logging function*1*2

Information can be saved to the SD memory card periodically from the computer and network equipment. Using the saved data enables efficient analysis of device operating status and trouble causes. If simple settings are made with the logging setting tool, no additional program is required.

A trouble can be analyzed efficiently by [trigger logging] which logs only the situation before and after the occurrence of trouble. Important data can be selectively saved by setting conditions.

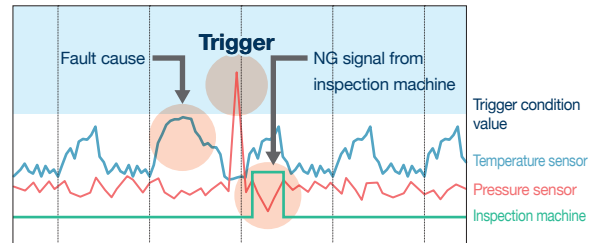

Collects data before and after occurrence of a trouble!

With the FTP server function*4, logging data can be acquired from a remote location without going to the site. Multiple logging files can be managed collectively from the office computer, reducing management and maintenance work.

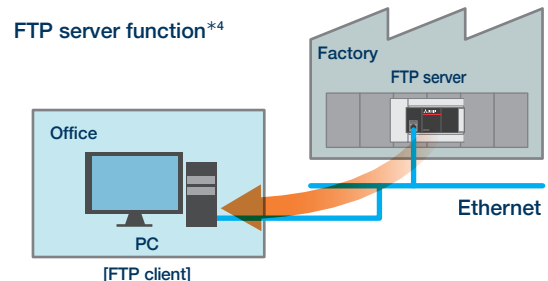

Logs can be examined and utilized from remote locations!

*1: Supported by FX5U/FX5UC Ver. 1.040 or later and product number 16Y**** or later, by GX Works3 Ver. 1.030G or later, and by CPU Module Logging Configuration Tool Ver. 1.64S or later.

*2: The data logging function and memory dump function cannot be used simultaneously. There are some restrictions on the use of the backup/restore functions. For details, refer to the manual.

*3: Supported by FX5U/FX5UC Ver. 1.100 or later, product number 17X**** (product number 178**** for FX5UC-32MT/DS-TS and FX5UC-32MT/DSS-TS) or later, and GX Works3 Ver. 1.047Z or later. Some operation restrictions apply when 128 k steps is selected. For details, refer to the manual.

*4: Supported by FX5U/FX5UC Ver. 1.040 or later and product number 16Y**** or later, and by GX Works3 Ver. 1.030G or later.

Efficiently analyzing logging data with GX LogViewer*1

GX LogViewer*1 is a tool to display and analyze large volumes of data collected by modules with the data logging function*2, with easy-to-understand operations. It enables the setting of the connection destination by the same operation as the setting tool and engineering tool, and thereby enables easy checking of the logging file.

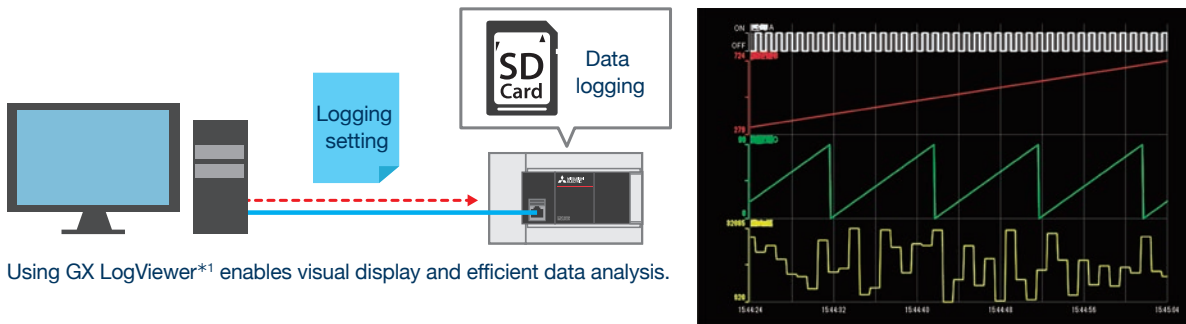

Security

It prevents data theft, tampering, misoperation, illegal execution, etc. caused by unauthorized access from a third party with the security functions (block password, file password, remote password, security key authentication).

>> Example of security key authentication function

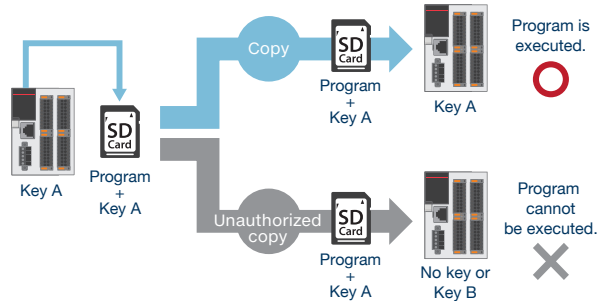

IP filter function*3

When the IP address to be permitted or blocked is set in the MELSEC iQ-F Series built-in function parameters, access from specific devices are restricted. The access source IP address can be identified to prevent accessing from illegal IP addresses.

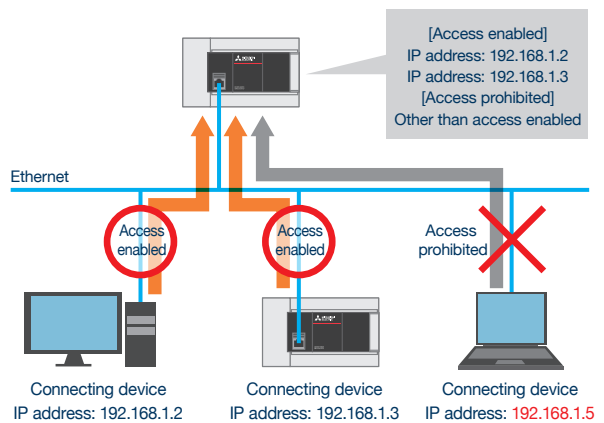

*1: Supported by GX LogViewer Ver. 1.64S or later.

*2: Supported by FX5U/FX5UC Ver. 1.040 or later and product number 16Y**** or later.

*3: Supported by FX5U/FX5UC Ver. 1.050 or later, and GX Works3 Ver. 1.035M or later.

Function introduction



Built-in functions

Backup/restore functions*1 (device/label data*2*3, data memory*4)

The device/label data and data memory in the CPU module can be backed up*5 to the SD memory card. Backed-up data can be restored as needed.

Back up data in case of an emergency!

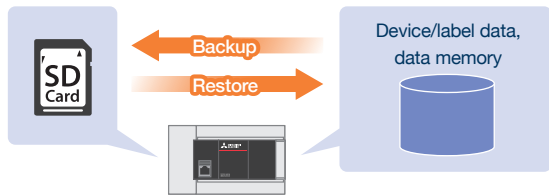

When the SD memory card is mounted in the CPU module, the data can be backed up at an arbitrary timing. The backed up data can be restored at any timing.

Restoration is possible even without a PC!

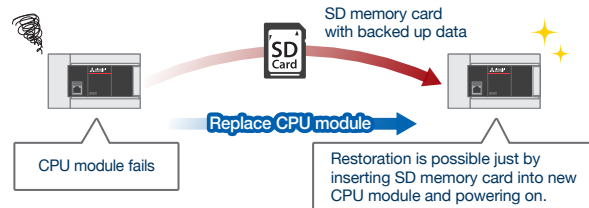

When the CPU module auto exchange function is used, the SD memory card data is automatically restored when the power is turned on or when the CPU module is reset. If the CPU module fails, it can recover promptly without a PC.

Memory dump function*6*7

The CPU module device value can be saved in the SD memory card at an arbitrary timing. By setting the trigger to be established when an error occurs, the status at error occurrence can be confirmed. This is helpful in investigating and pinpointing the cause.

By setting memory dump...

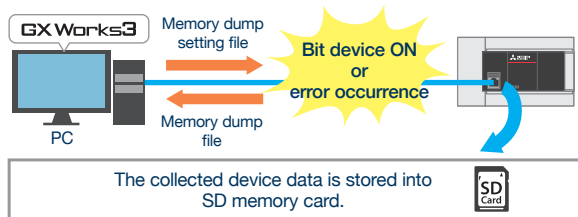

Use the information when debugging systems under development, or for troubleshooting when trouble occurs at a remote location, etc.

Memory dump results display screen

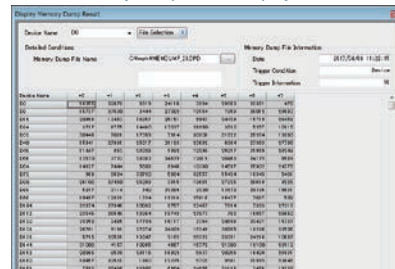

The collection results can be confirmed with GX Works3. The device list can be displayed in the memory dump results display, and the memory dump conditions can be repeated on the offline monitor.

Caution

If the data protected by the file password function exists in the CPU module, backup/restore is disabled. When setting the security key authentication function, the program cannot be executed unless the security key has been written to the CPU module.

*1: While the backup/restore function is executed, some functions are temporarily unavailable. For details, refer to the manual.

*2: Supported by FX5U/FX5UC Ver. 1.045 or later.

*3: Excluding the buffer memory of the intelligent function module.

*4: Supported by FX5U/FX5UC Ver. 1.050 or later.

*5: Supported by FX5U/FX5UC product number 16Y*** or later.

*6: The memory dump function and data logging function are not simultaneously available. There are some restrictions on the use of the backup/restore functions. For details, refer to the manual.

*7: Supported by FX5U/FX5UC Ver. 1.050 or later and product number 16Y*** or later, and by GX Works3 Ver. 1.035M or later.

Real-time monitoring function*1

The contents of any devices can be monitored on real-time basis using GX LogViewer*2. Because changes in device values are displayed in a trend graph, changes can be noticed at a glance!

The debugging efficiency is considerably improved at startup and troubleshooting. This function facilitates the resetting procedure, and enables graph check at a later time.

Real-time monitoring of data collected by CPU module using numerical values and graphs

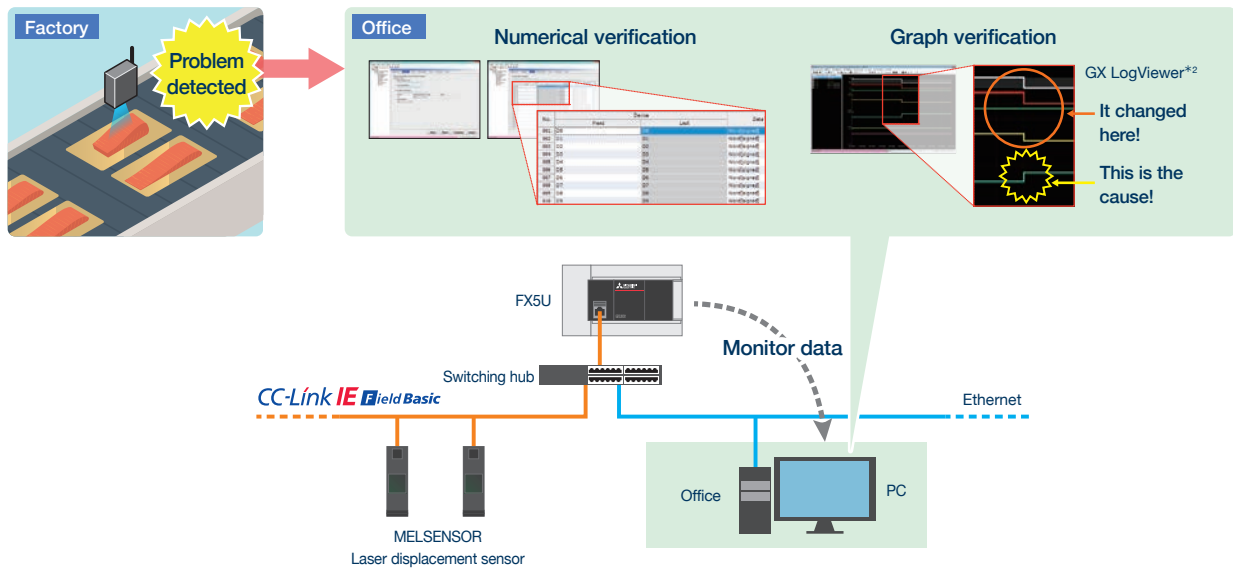

*1: Supported by FX5U/FX5UC Ver. 1.060 or later, and GX Works3 Ver. 1.040S or later.

*2: Supported by GX LogViewer Ver. 1.76E or later.

Function introduction



Analog control

The FX5U CPU module has a built-in analog input/output function. In addition, it can also input and output analog quantities (voltage, current etc.) using expansion adapters and extension modules. Analog control suitable for the application is possible by using a variety of extension modules in addition to the analog input/output function of the CPU module.

List of models

	3 ch	4 ch			8 ch
Analog input	<p>2 ch</p>	<p>FX5-4AD-ADP</p>	<p>FX5-4AD</p>	<p>FX3U-4AD*</p>	<p>FX5-8AD</p> <p>[8 ch] multi input (Selectable in channels)</p> <ul style="list-style-type: none"> · Voltage · Current
Analog output	<p>1 ch</p> <p>FX5U CPU module</p>	<p>FX5-4DA-ADP</p>	<p>FX5-4DA</p>	<p>FX3U-4DA*</p>	
Temperature/ temperature control		<p>Temperature sensor input</p> <p>For thermocouple</p> <p>FX5-4AD-TC-ADP</p>	<p>Temperature control</p> <p>4 ch FX5-4LC</p> <p>[4 ch] temperature input (Selectable in channels)</p> <p>[4 ch] transistor output</p> <ul style="list-style-type: none"> · Two-position control · Heating-cooling control · PID control 		<p>FX5-8AD</p> <p>[8 ch] multi input (Selectable in channels)</p> <ul style="list-style-type: none"> · Resistance temperature detector (Pt100, Ni100) · Thermocouple (K, J, T, B, R, S)
		<p>For resistance temperature detector</p> <p>FX5-4AD-PT-ADP</p>	<p>4 ch FX3U-4LC*</p> <p>[4 ch] temperature input (Selectable in channels)</p> <p>[4 ch] transistor output</p> <ul style="list-style-type: none"> · Two-position control · Heating-cooling control · PID control · Cascade control 		

Analog input/output (with alarm output) control using built-in function

FX5U CPU module



The FX5U CPU module has built-in 12-bit 2-channel analog voltage input and 1-channel analog voltage output. It can be used with only parameter setting without programming. Numerical shift, scaling setting, and alarm output setting can also be easily set with parameters.

Example of inverter control using analog output

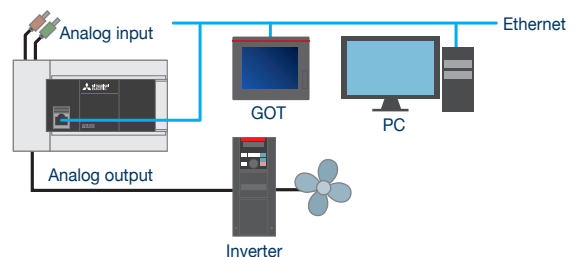

*: Connection with FX5U/FX5UC requires FX5-CNV-BUS or FX5-CNV-BUSC.



New compact*1 4 ch products capable of analog input/analog output

Analog input module FX5-4AD
Analog output module FX5-4DA

Conversion speed "80 μs/ch" realized

4AD 4DA

Both the analog input module and the analog output module have realized the conversion speed as fast as 80 μs/ch, which has considerably improved compared with conventional modules.

● Analog input module

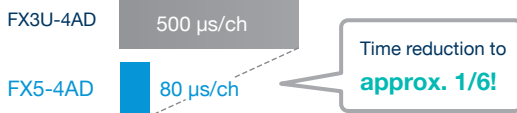

● Analog output module

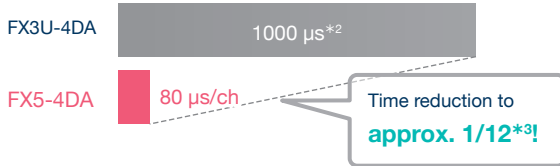

Analog processing of higher accuracy

4AD 4DA

The accuracy has improved in analog inputs and analog outputs. The analog processing of higher accuracy has been enabled.

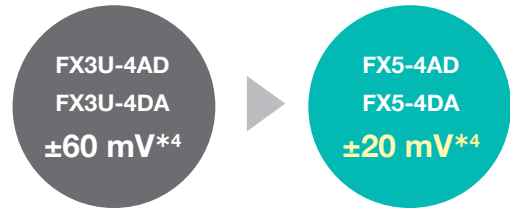

Logging function to cope with troubles

4AD

By using the logging function, the operator can acquire data at a specified interval or any timing. The operator can analyze data acquired before and after occurrence of a trouble, and efficiently investigate causes of the trouble.

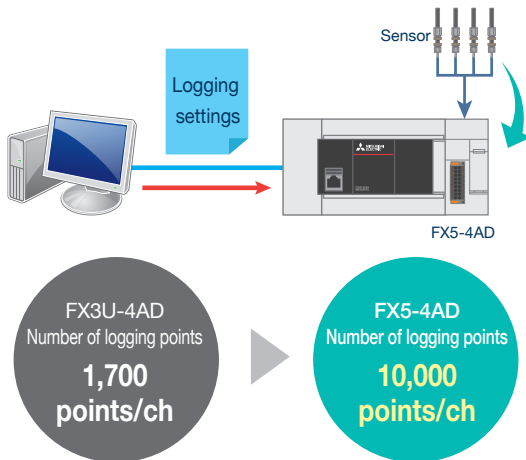

Wave output function offering smooth wave without any program

4DA

- The operator can easily create graphical wave output data expressed in arcs and straight lines using GX Works3.
- The operator can update analog output values in the D/A conversion cycle (80 μs at highest speed) without depending on the scan time.
- The operator can register the wave output data in the analog output module, and repeatedly use them to reduce the man-hours for programming.

- With analog output using the wave output function
An analog value is output at a constant interval.

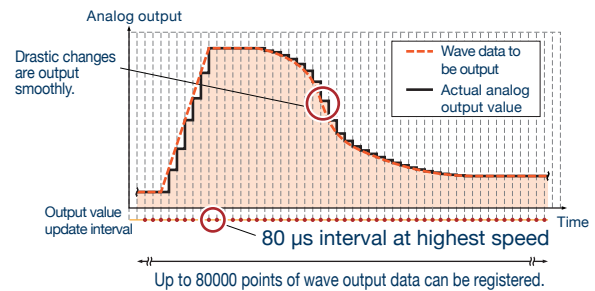

Wave closer to the wave to be output can be obtained!

*1: When compared with Mitsubishi FX3U-4AD and FX3U-4DA.
*3: In the case of 1 ch use

*2: 1000 μs without regard to the number of channels.
*4: When the ambient temperature is 25±5°C, and the "-10 to +10 V" range is selected.

Function introduction



Analog control

Voltage, current, thermocouple, and resistance temperature detector inputs can be used for multiple applications with a single module!



Multiple input module FX5-8AD

Providing support for various applications

Voltage, current, thermocouple (K, J, T, B, R, S), and resistance temperature detector (Pt100, Ni100) inputs are supported.

Possible to set input type per channel!

Analog input Total 8 channels

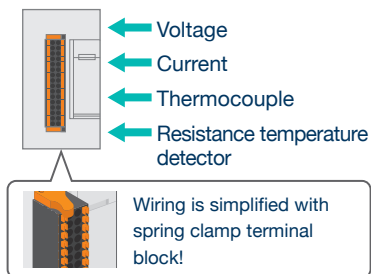

Easily detect disconnection

Thermocouple and resistance temperature detector disconnection can be easily detected, so downtime and maintenance cost can be reduced.

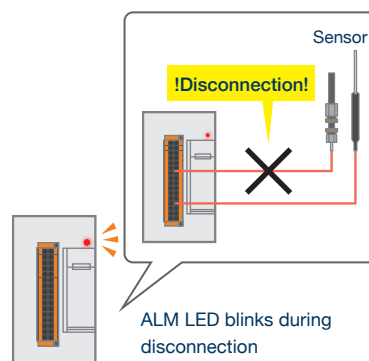

Analyze problems with logging function

10000 points of data per channel can be logged and stored to buffer memory.

If the log is saved, it can be useful in investigating the cause of the problem.

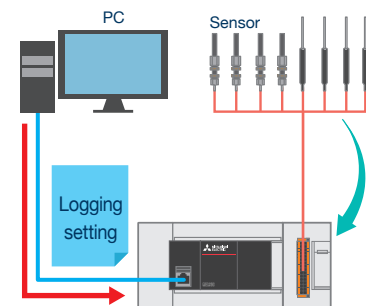

4-channel input/output compatible temperature control is possible!

Temperature control module FX5-4LC



Various temperature sensors can be used

Supports thermocouple, resistance temperature detector, and micro voltage inputs. Possible to support a variety of applications.

Possible to set input type per channel!

Temperature sensor input Total 4 channels (isolation between channels)

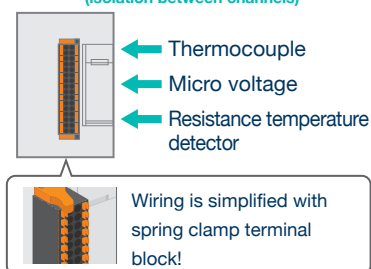

PID control supported

Overshooting where the output value exceeds the target value, and hunting phenomenon where vibration occurs around the target value can be suppressed.

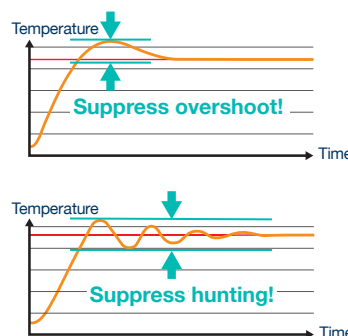

Supports temperature trace

Temperature change can be checked on a waveform. While checking the temperature waveform displayed in realtime, parameters can be adjusted.

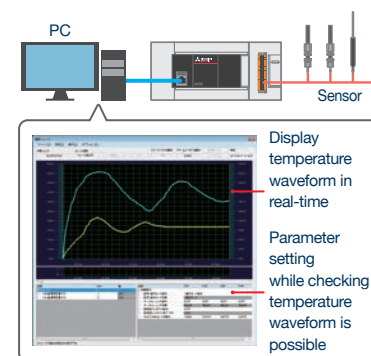







memo



Positioning control

The FX5U/FX5UC CPU module has a built-in positioning function. Complex multi-axis/interpolation control is also possible by using a high-speed pulse input/output module or simple motion module.

List of models

	1-axis	2-axis	4-axis	8-axis
CPU module (built-in positioning, high-speed pulse I/O module)		 FX5-16ET/ES-H, FX5-16ET/ESS-H	 FX5U/FX5UC CPU module	
Positioning module	 FX3U-1PG*1	 FX5-20PG-P	 FX5-20PG-D NEW	
Simple motion module			 FX5-40SSC-S	 FX5-80SSC-S

Built-in positioning (200 kpps, 4 axes built in) compatible with high-speed startup of 20 μs



FX5U/FX5UC CPU module

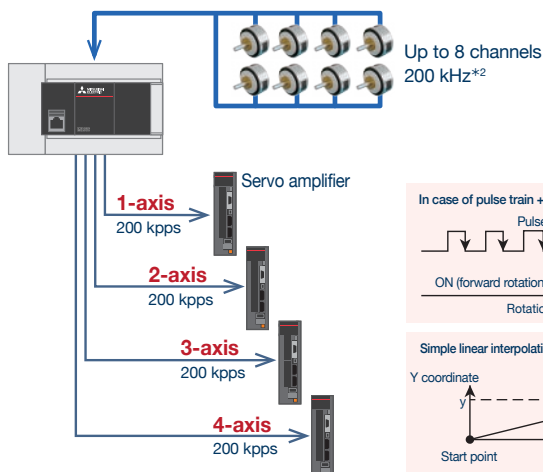

The FX5U/FX5UC CPU module is equipped with the high-speed counter function with 8 channels high-speed pulse input channels and the built-in positioning function by 4-axis pulse output. In addition to conventional functions, such as interrupt stop operations and variable speed operations, new functions are added, making the built-in positioning function easier to use.

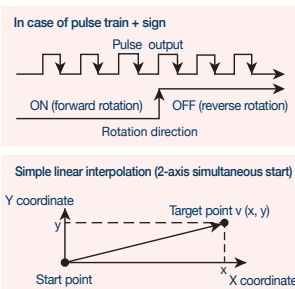

[Example of packing apparatus using built-in positioning]

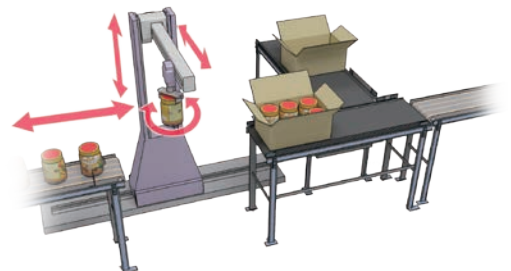

*1: Connection with FX5U/FX5UC requires FX5-CNV-BUS or FX5-CNV-BUSC.
*2: 6 ch 200 kHz + 2 ch 10 kHz only for FX5U-32M and FX5UC-32M.

Reasonably realizing multi-axis control with CPU module and high-speed pulse input/output module



High-speed pulse input/output module FX5-16ET/ES-H, FX5-16ET/ESS-H

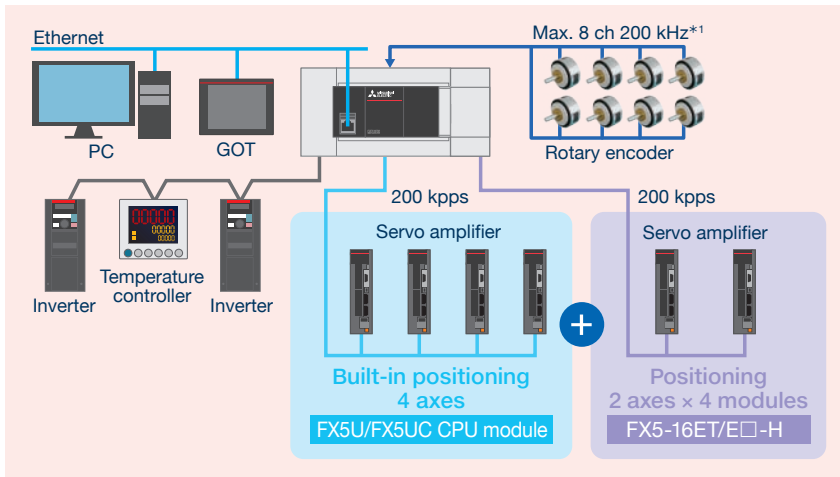

CPU module 4 axes
 + FX5-16ET/E□-H 2 axes × 4 modules = 8 axes

Total of 12 axes of control is possible!

Faster startup and 2-axis positioning for increased flexibility!



2-axis pulse train positioning module FX5-20PG-P (Transistor output)
 FX5-20PG-D (Differential driver output) **NEW**

Introducing differential driver output positioning modules

In addition to transistor output models, a new differential driver output model has been added to the lineup.



Transistor output type
FX5-20PG-P



Differential driver output type
FX5-20PG-D

The maximum output pulse is 5 M pulses/s, and the connection distance is 10 m.*2

With maximum output pulses of 5 M pulses/s for the FX5-20PG-D, control is possible for devices with higher resolutions than conventional products. The maximum connection distance between servos is 10 m.

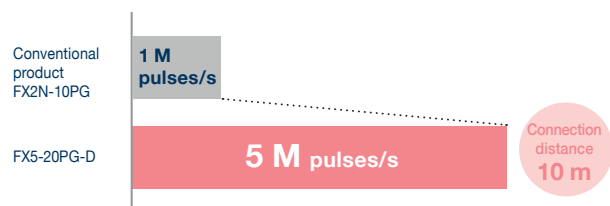

High-speed start realized

The high-speed normal positioning starting process speed can shorten the starting time to 0.5 ms.

■ Comparison of starting times for 1-axis linear control

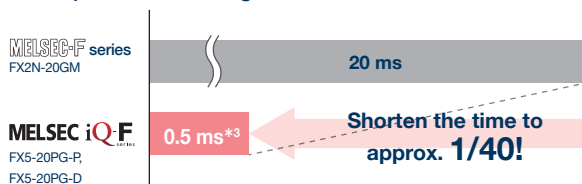

Quick start function supported

By analyzing the positioning data in advance, it is possible to start the positioning at a higher speed than the normal positioning start.

■ Comparison of starting times

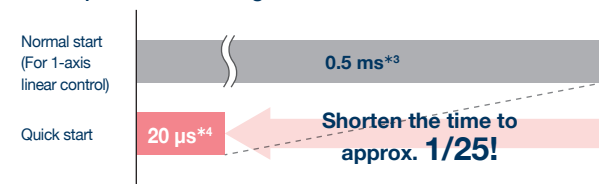

*1: 6 ch 200 kHz + 2 ch 10 kHz only for FX5U-32M and FX5UC-32M

*2: For FX5-20PG-P, the maximum pulse output is 200k pulses/s, and the maximum connection distance is 2 m.

*3: 1-axis linear control/1-axis speed control. For other controls, refer to the manual.

*4: Start by external command signal. 30 μs in the case of start by positioning start signal.

Function introduction



Positioning control

Simple motion module (4/8-axis control module)



Simple motion module (4/8-axis control module) FX5-40SSC-S, FX5-80SSC-S

Positioning control with SSCNET III/H

The simple motion module is equipped with the 4/8-axis positioning function compatible with SSCNET III/H.

It can be used for various purposes by combining linear interpolation, 2-axis circular interpolation, constant quantity feed, and continuous path control in a table-based program.

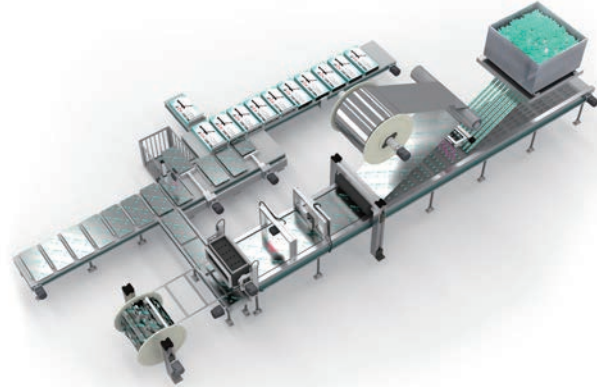

Main functions

- Linear interpolation
- Circular interpolation
- Continuous path control
- S-curve acceleration/ deceleration

Application examples

- Sealing system
- Palletizer
- Grinding system

Making simple motion with compactly packed extra functions

By starting with parameter settings and the sequence program, the simple motion modules can realize a variety of motion control including positioning control, advanced synchronous control, cam control and speed-torque control.

Synchronous control

In addition to synchronous control by replacing hardware mechanisms such as gears, shafts, transmissions, and cams with software, functions such as cam control, clutch, and cam auto generation can be easily realized. In addition, since synchronous control can be started and stopped for each axis, it is possible to mix the synchronous control axis and the positioning control axis.

Up to four axes*1 can be synchronized to the synchronous encoder axis, enabling use with a variety of systems.

- Synchronous control and cam control can be used to build a system perfect for your equipment.
- Up to 64 types*2 of cam patterns can be registered to respond quickly to any type of contents.
- Continuous operation can be performed without stopping the workpiece.

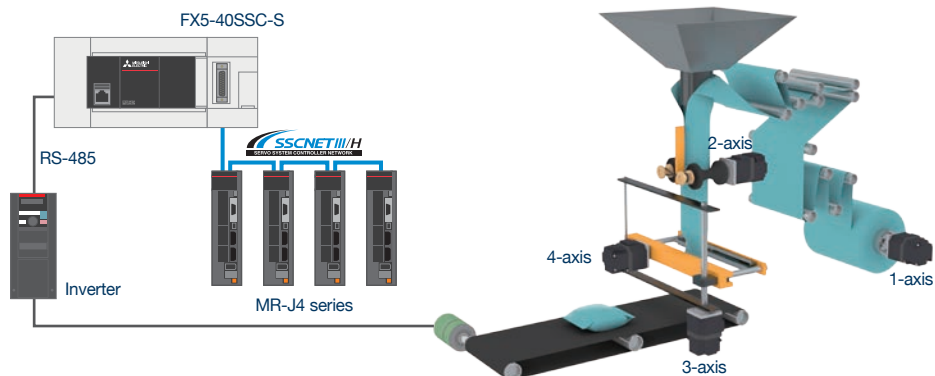

*1: FX5-80SSC-S: 8 axes

*2: FX5-80SSC-S: 128 types

Mark detection function

The cutter axis deviation can be compensated by detecting a mark on the workpiece so the workpiece can be cut at a constant position.

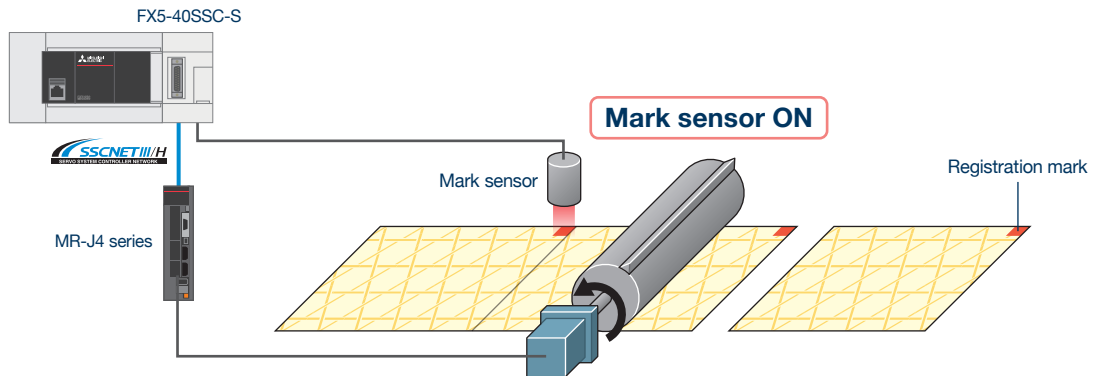

Cam data auto-generation

Cam data of the rotary cutter, which was conventionally difficult to create, can be automatically generated simply by inputting sheet length, synchronization width, cam resolution, etc.

Also, saving the cam data in the cam save area enables continuous use of the last cam data even after power off, and thus can shorten the start-up time of the system and realize multi-product production.

User-created GOT screen

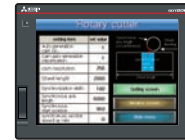

Parameter settings, including items like sheet length, etc.

Item		FX5-40SSC-S	FX5-80SSC-S
Memory capacity	Cam save area	64 k bytes	128 k bytes
	Cam load area	1024 k bytes	
Max. number of registrations*1	Cam save area	Up to 64	Up to 128
	Cam load area	Up to 256	

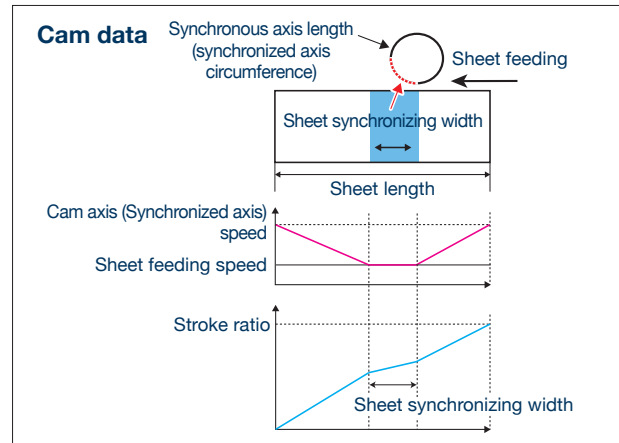

Various driving equipment

Not only rotary servomotors but also linear servomotors, direct drive motors, inverter FR-A800 series, and partner maker equipment can be connected.

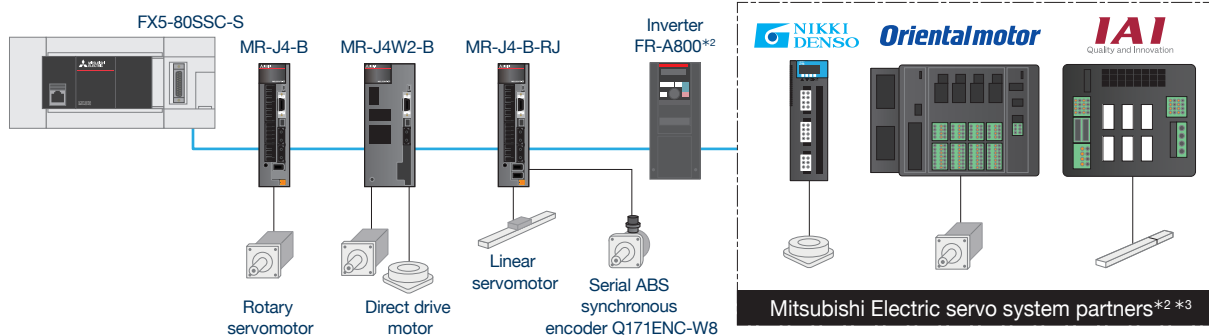

*1: The maximum number of registered cams varies depending on the memory capacity, cam resolution, and the number of coordinates. For details, refer to the manual.

*2: For partner products and inverter FR-A800, use the versions compatible with the simple motion module.









*3: For details of partner products, refer to the servo system partner product catalog.



Network/communication

The MELSEC iQ-F series can build high-speed networks by CC-Link and other networks corresponding to the control contents such as Ethernet, MODBUS, Sensor Solution, and PROFIBUS-DP. In addition, CC-Link IE Field Network Basic is a factory automation network that utilizes general-purpose Ethernet connections to enable efficient creation of factory-wide systems.

List of models

<p>CC-Link V2</p>  <p>FX5-CCL-MS FX3U-16CCL-M*1 FX3U-64CCL*1</p>	<p>CC-Link IE Field Network</p>  <p>FX5-CCLIEF</p>			
<p>CC-Link IE Field Network Basic</p>  <p>FX5U/FX5UC CPU module (Ethernet port) FX5-ENET NEW</p>	<p>Ethernet</p>  <p>FX5U/FX5UC CPU module (Ethernet port) FX5-ENET NEW</p>	<p>EtherNet/IP</p>  <p>FX5-ENET/IP NEW</p>		
<p>MODBUS/RTU</p>  <p>FX5U/FX5UC CPU module (Built-in RS-485 port) FX5-232ADP FX5-485ADP FX5-232-BD*2 FX5-485-BD*2</p>				
<p>Sensor Solution</p>  <p>FX5-ASL-M FX3U-128ASL-M*1</p>		<p>PROFIBUS-DP</p>  <p>FX5-DP-M NEW FX3U-32DP*1</p>		
<p>Serial communication</p>  <p>FX5U/FX5UC CPU module (Built-in RS-485 port) FX5-232ADP FX5-485ADP FX5-232-BD*2 FX5-485-BD*2</p>				

*1: Connection with FX5U/FX5UC requires FX5-CNV-BUS or FX5-CNV-BUSC.

*2: Can be connected only to the FX5U CPU module.

Communication using RS-485 or RS-232C equipment

Parallel link function*1

This function connects two CPU modules and automatically links mutual device data. ON/OFF status and data register values of the other station can be checked.

Normal parallel link mode/high-speed parallel link mode can be selected depending on the desired number of link points and link time. Parallel link can only be used on one channel of the CPU module.

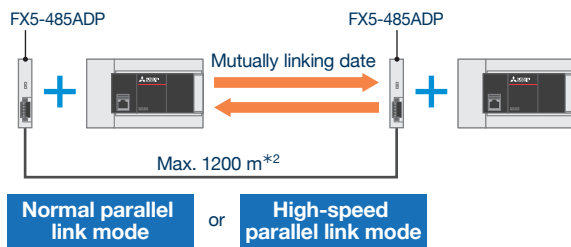

MODBUS communications

FX5 PLC can connect, as a master or slave station of MODBUS communication, to various MODBUS communication devices.

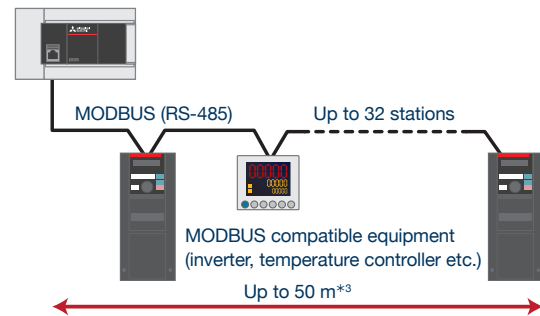

Non-protocol communication

Non-protocol serial communication can be performed with RS-232C/RS-485 interface devices such as code readers, printers, personal computers, and measuring instruments.

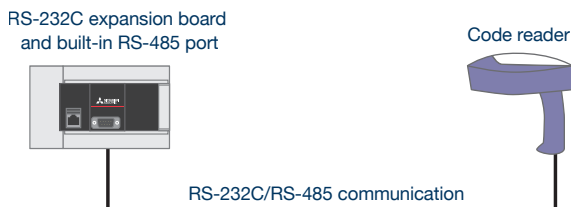

N:N Network

In this communication, a connection is set up with the FX5 PLC or FX3 PLC through RS-485 communication to automatically exchange data.

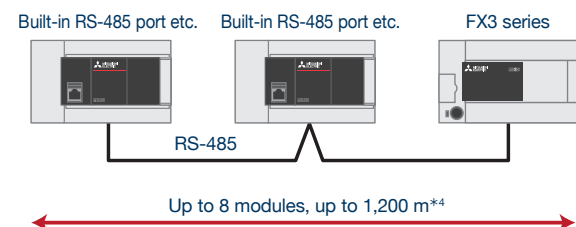

Inverter communication

Up to 16 inverters can be operated and controlled by RS-485 communication.

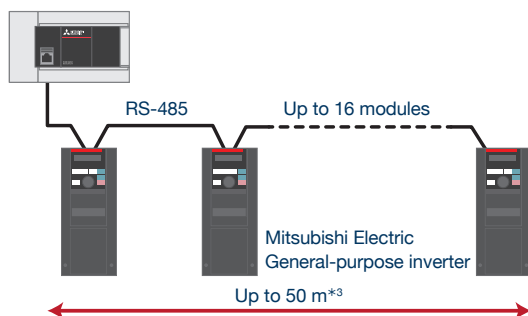

- IVCK: Operation monitor
- IVDR: Operation control
- IVRD: Parameter read
- IWWR: Parameter write
- IVBWR: Parameter batch write
- IVMC: Multiple command
(2 types of settings and 2 types of read)

*1: Supported by FX5U/FX5UC Ver. 1.050 or later, and GX Works3 Ver. 1.035M or later.

*2: 50 m or less when the built-in RS-485 port and FX5-485-BD are included.

*3: Built-in RS-485 or RS-485 expansion board

*4: When configured with FX5-485ADP. The distance varies depending on the type of communications equipment.

Function introduction



Network/communication

Communication using Ethernet

Built-in Ethernet communication

Compatible models: Built-in Ethernet / Ethernet modules

Supports CC-Link IE Field Network Basic, FTP server, and other protocols, and enables configuration of communication settings easily with parameters. Also supports various functions such as the GX Works3 diagnostic function, SLMP communication function, socket communication function, and IP address change function, and prevents unauthorized accesses from the outside by remote passwords.

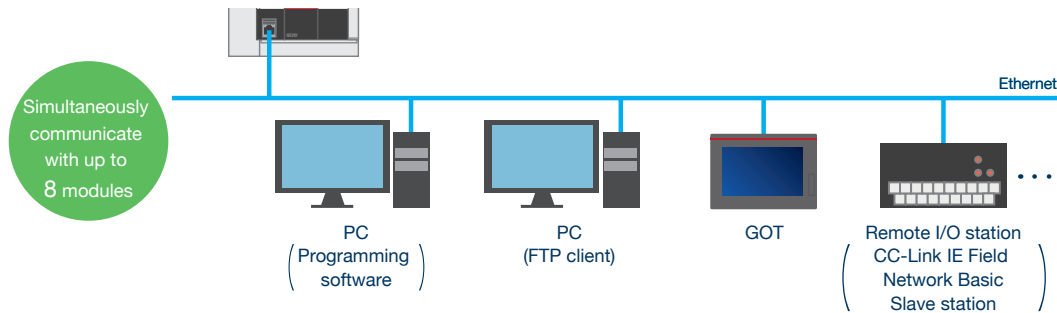

SLMP communication

Compatible models: Built-in Ethernet / Ethernet modules

Device data of a CPU module can be read from/written to the PC, etc. using SLMP*, which is a common protocol. Because seamless communication is possible like a single network, equipment can be monitored and programs can be modified from anywhere in the office or work site.

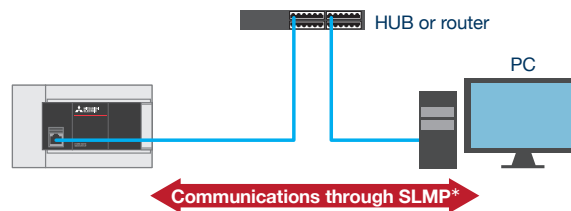

Remote maintenance

Compatible models: Built-in Ethernet / Ethernet modules

GX Works3 can be connected via VPN, and programs can be read/written. Troubleshooting can be performed from a remote place without going to the site, which leads to a reduction in maintenance costs.

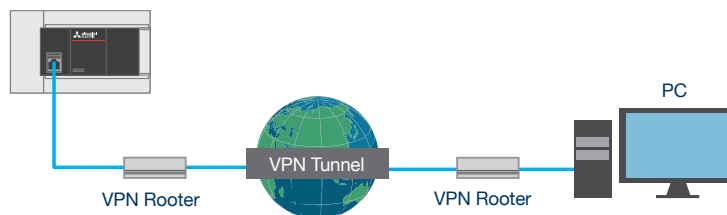

Web server function*1 **NEW**

Compatible models: Built-in Ethernet / Ethernet modules

Accessing the Web server from a Web browser on a PC enables CPU module monitoring and diagnosis without any dedicated tools. User Web pages*2 unique for each user can also be created.

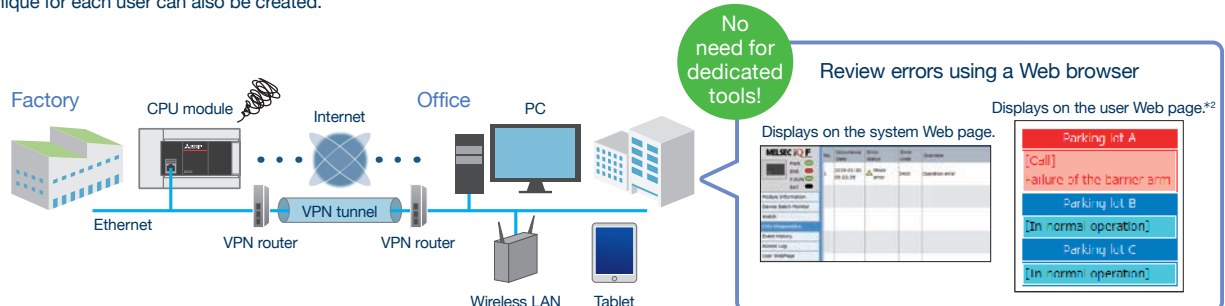

Simple CPU communication function*3 **NEW**

Compatible models: Built-in Ethernet / Ethernet modules

Using a simple parameter setting with GX Works3, device data such as production data can be transferred without any program. Communication with existing systems using MELSEC iQ-R series, -Q series, and -L series devices can be easily performed.

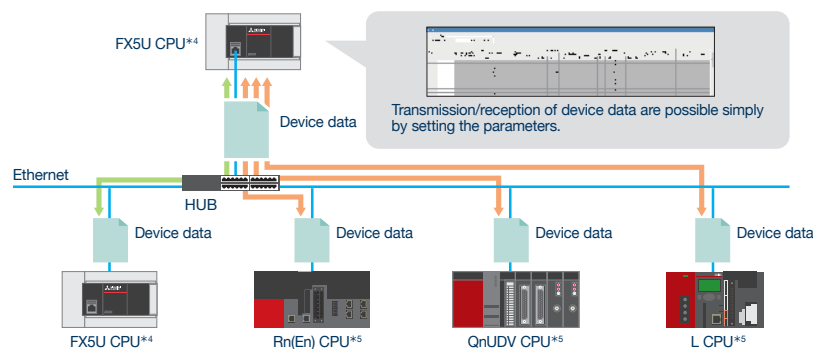

For CC-Link IE Field Network Basic, the number of connectable modules is increased to 16. **NEW**

Compatible models: Built-in Ethernet / Ethernet modules

By increasing the number of connectable modules from 6 (with conventional versions) to 16, usability is improved. Because remote I/O stations connected by CC-Link IE Field Network Basic are not included in the total remote I/O points*3, the user can expand modules without worrying about the number of remote I/O points.

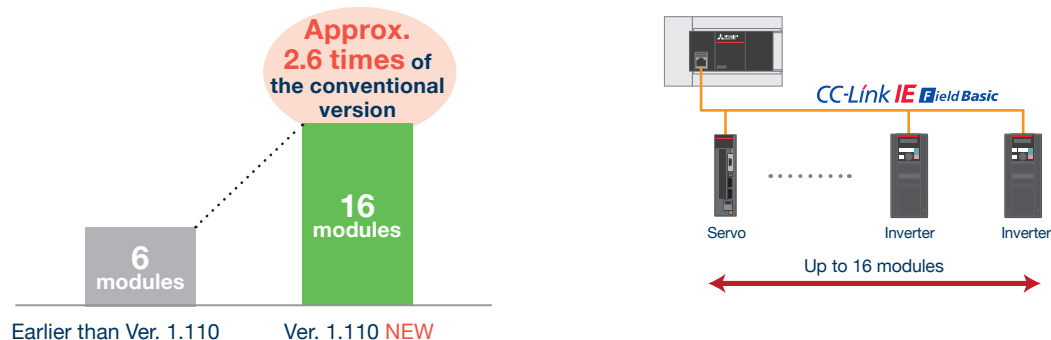

*1: Supported by FX5U/FX5UC Ver. 1.060 or later, and GX Works3 Ver. 1.040S or later.

*2: Supported by FX5U/FX5UC Ver. 1.100 or later, product number 17X**** (product number 178**** for FX5UC-32MT/DS-TS and FX5UC-32MT/DSS-TS) or later, and GX Works3 Ver. 1.047Z or later.

*3: Supported by FX5U/FX5UC Ver. 1.110 or later, and product number 17X**** (product number 178**** for FX5UC-32MT/DS-TS and FX5UC-32MT/DSS-TS) or later, and GX Works3 Ver. 1.050C or later.

*4: Built-in Ethernet function

*5: Requires connecting device configuration.

Function introduction

Network/communication

With the expansion of Ethernet ports, a wider variety of communication is possible.

FX5-ENET Ethernet module **NEW**



CC-Link IE Field Network Basic

Compatible models: Built-in Ethernet / Ethernet modules

CC-Link IE Field Network Basic is a factory automation network that utilizes general-purpose Ethernet connections. Link devices are used to periodically transmit data (cyclic transmission) between the master station and slave stations. General-purpose Ethernet connections can be used to create a network that includes both the host system and production site equipment.

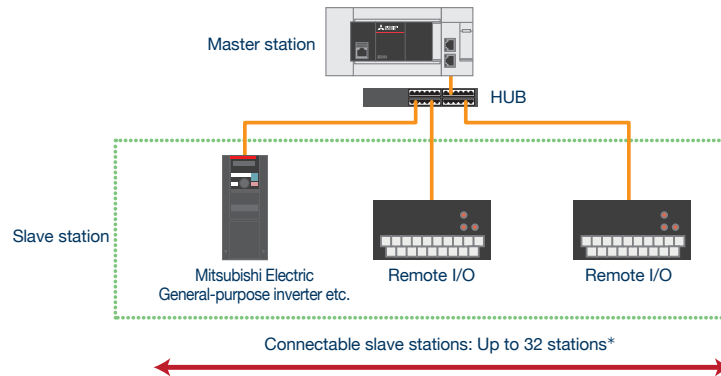

• Capable of grouping of slave stations

Grouping stations according to the length of response processing time is possible. The cyclic transmission can be performed while suppressing influence by the difference in standard response times of each slave station.

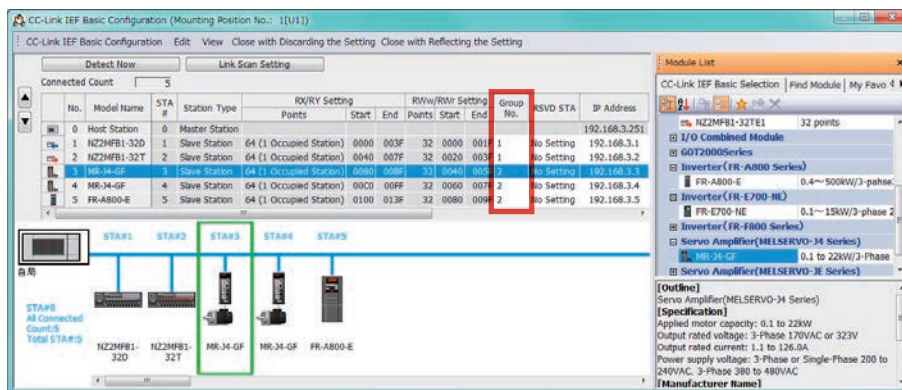

Socket communication function

Compatible models: Built-in Ethernet / Ethernet modules

Data communication with Ethernet-connected devices is possible via TCP or UDP.

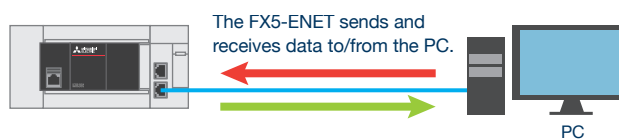

*: The number of connectable modules varies depending on the number of stations occupied by a slave station.

Connectable to EtherNet/IP Network

EtherNet/IP module FX5-ENET/IP **NEW**



EtherNet/IP communication

CIP communication protocol achieves a seamless communication with EtherNet/IP Network. EtherNet/IP and general purpose Ethernet can coexist.

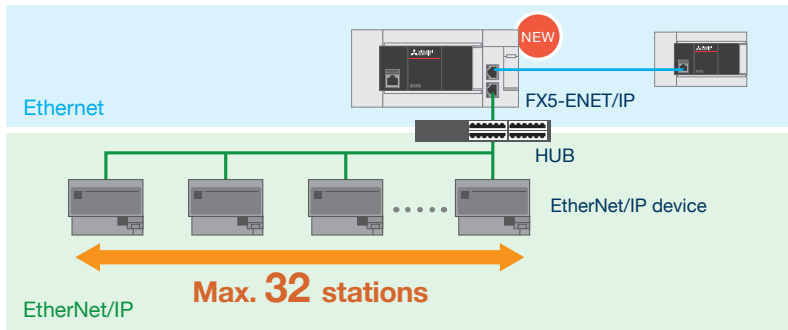

Note: IP address of FX5-ENET/IP is shared by 2 ports.

Connectable to CC-Link IE Field Networks

CC-Link IE Field Network intelligent device module FX5-CCLIEF



CC-Link IE Field Network

CC-Link IE Field Network is a high-speed, high-capacity open field network that uses Ethernet connections.

Using the FX5-CCLIEF makes it possible to connect an FX5 CPU module to the CC-Link IE Field Network as an intelligent device station.

The network's flexible wiring methods—including ring, star, and line topologies—help reduce wiring costs and improve reliability.

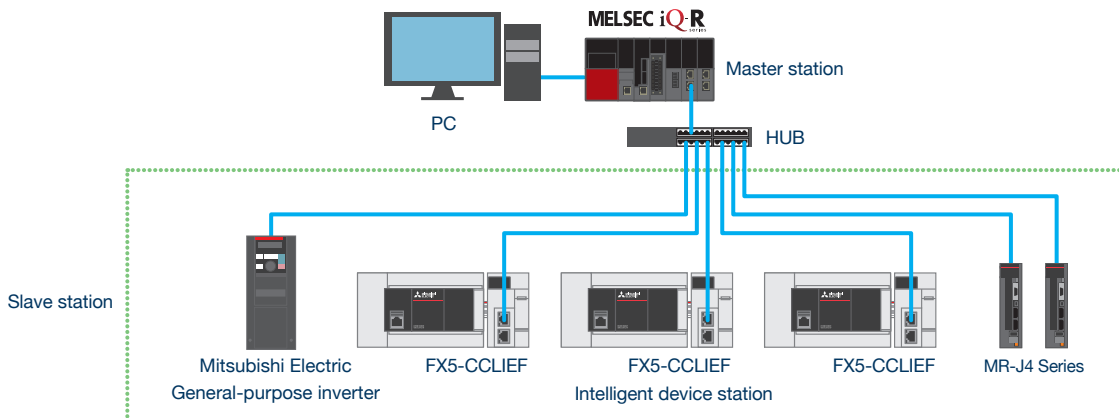

Function introduction



Network/communication

CC-Link communication

CC-Link system master/intelligent device module FX5-CCL-MS



Enables building network systems compatible with CC-Link V2 at low cost. Since FX5-CCL-MS has both functions, the master station and intelligent device station, it can be used as either of them by switching with parameters.

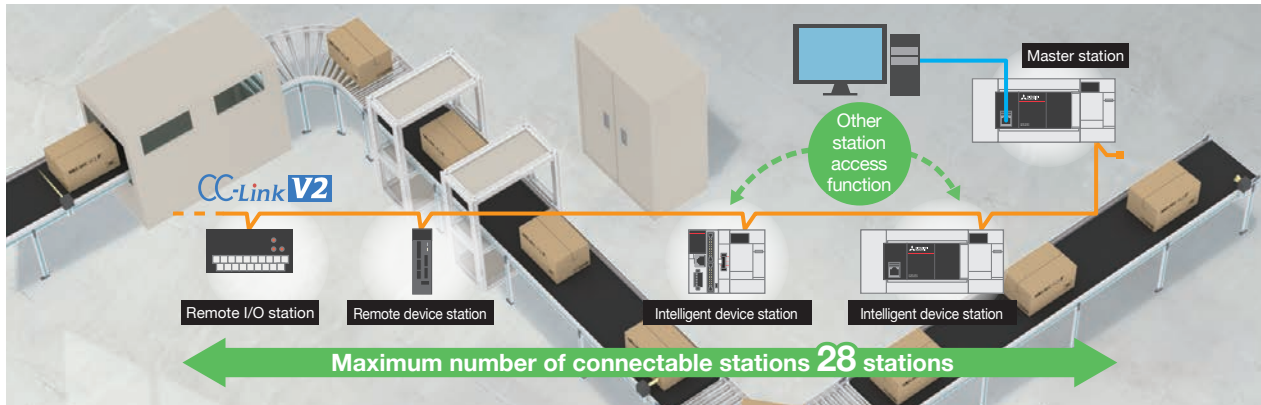

Other station access function supported

Perform program write/read and device monitoring, etc. for another station's PLC within the same network using the GX Works3 connected to own station.

There's no need to connect GX Works3 and perform programming for each MELSEC iQ-F series module, so programming man-hours can be reduced.

Equipped with master station/ intelligent device station functions

The module is equipped with both the master station and intelligent device station functions, so it can be used for either type of station by changing the parameter.

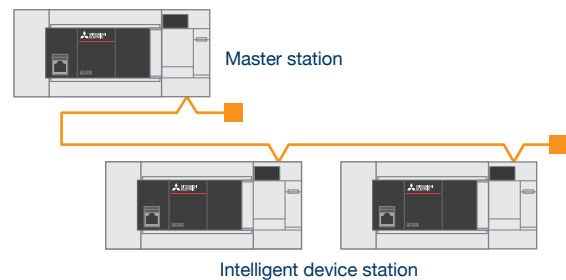

Connection to AnyWireASLINK system

AnyWireASLINK system master module FX5-ASL-M



Can be connected to the AnyWireASLINK system made by AnyWire Co., Ltd. "Visualization" of sensors has been strengthened by collaboration with sensors and Mitsubishi Electric FA products. It is useful for preventive maintenance such as sensor disconnection detection.

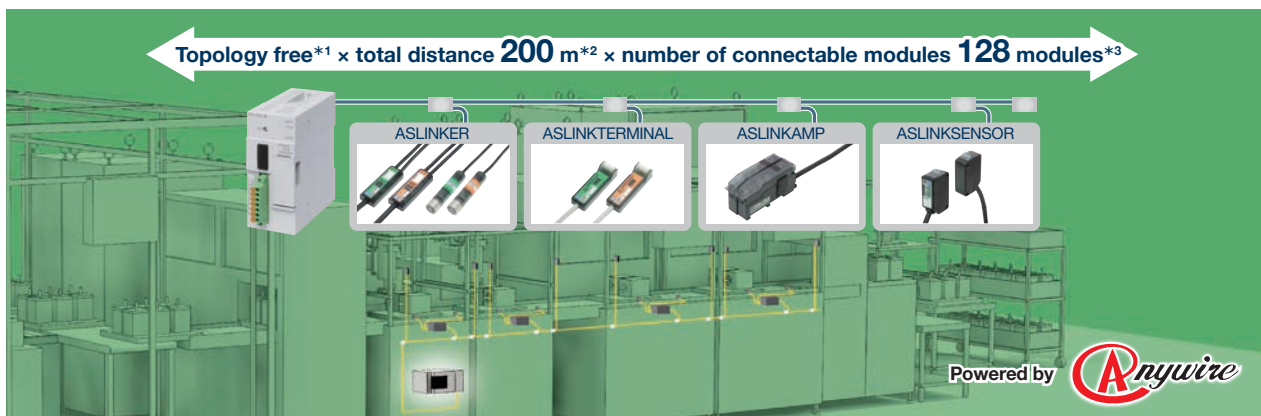

*1: There is no regulation about such as the specification of branching method and minimum distance between terminals.

*2: Total extension distance including branch line length.

*3: The number varies depending on current consumption of each slave module.

PROFIBUS-DP

PROFIBUS-DP master module FX5-DP-M NEW



PROFIBUS is an industrial fieldbus developed and maintained by the PROFIBUS & PROFINET International (PI). This protocol enables high-speed data transmission between field devices such as a remote I/O module or drive and a controller.

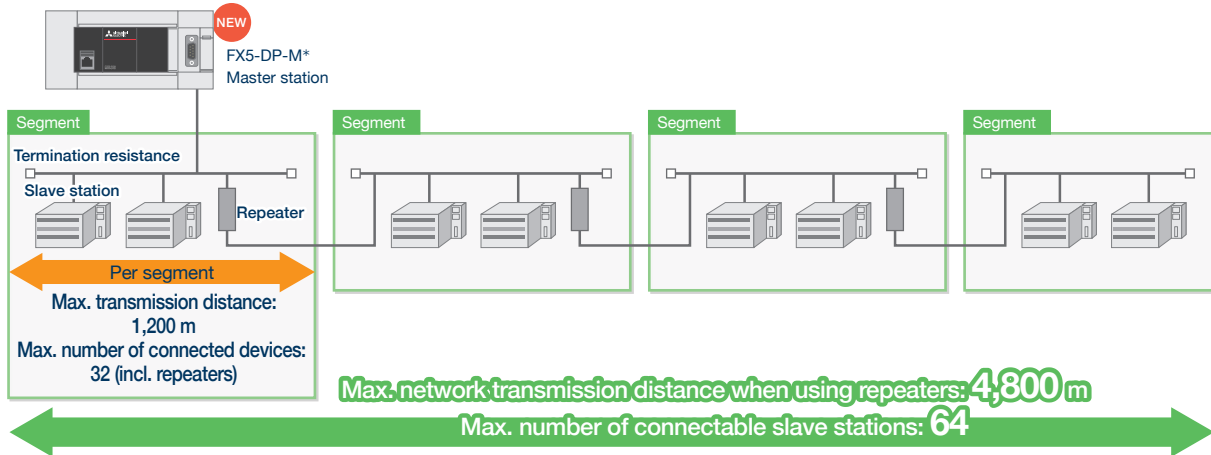

Max. 12 Mbps high-speed, large-capacity communication

High-speed communication is possible at up to 12 Mbps. Up to 64 slave stations per FX5-DP-M for input/output connections. Data transmission is possible at up to 2048 bytes (with a max. of 244 bytes of I/O data per slave station).

Reading/writing I/O data

Input/output data can be read/written between a CPU module device and the FX5-DP-M buffer memory. To read or write I/O data, configure the refresh settings on the PROFIBUS Configuration Tool, or use MOV command or FROM/TO command programs.

Obtain communication failure information from slave stations

Using the buffer memory makes it possible to obtain communications error information or extended communications error information generated by a slave station during I/O data transmission.

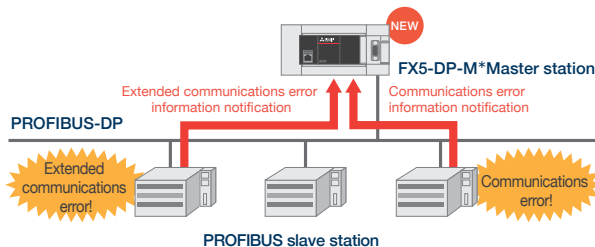

*: Connection with FX5UC requires FX5-CNV-IFC or FX5-C1PS-5V.



Programming environment GX Works3

GX Works3 is software that comprehensively supports the design and maintenance of sequence programs. Graphical intuitive operability, and easy programming by just “selecting”. A diagnostic function that has a troubleshoot function realizes the reduction of engineering cost.

System design with a convenient parts library

With GX Works3, designing a system is as easy as preparing the module configuration diagram by dragging and dropping selected parts.

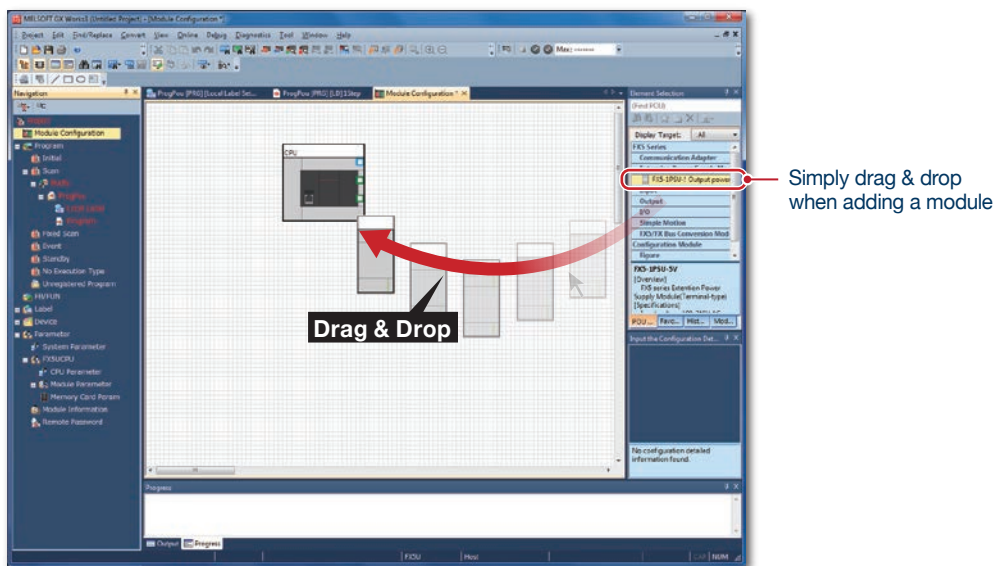

Auto-generation of module parameters

When preparing the module configuration diagram, simply double-click the module to automatically generate the module parameters. A window with an easy-to-use parameter settings screen opens, enabling module parameters to be modified as needed.

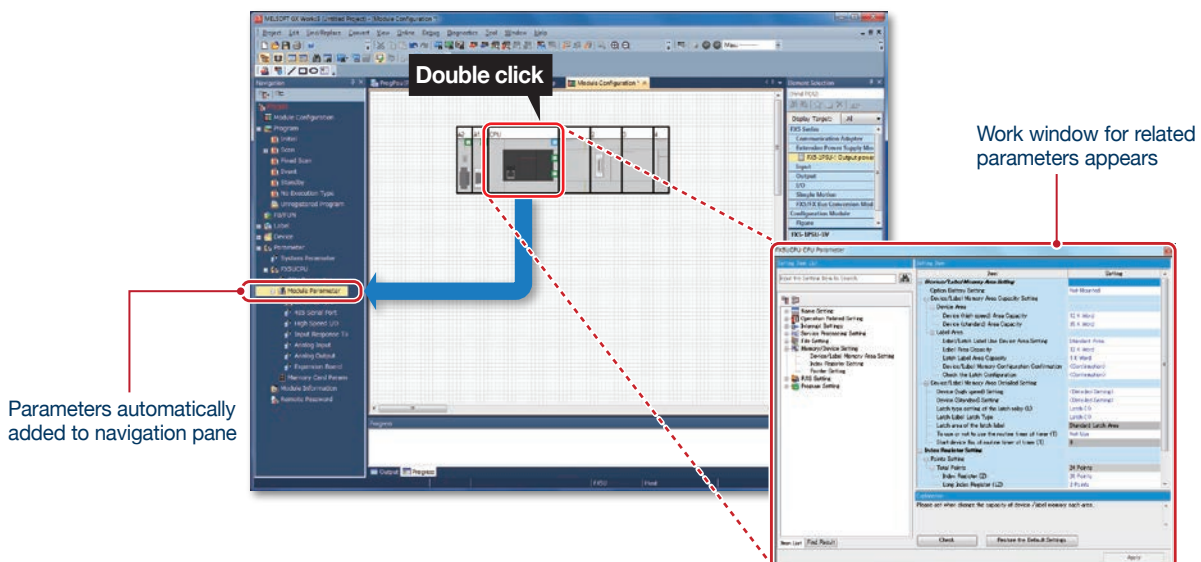



Ladder language edition



FBD/LD language edition

YouTube
MITSUBISHI ELECTRIC Factory Automation
MELSEC iQ-F Series Quick Start Guide



You can see the basics of programming using GX Works3 from the catalog on the left or reading the QR code.
L(NA)08449ENG

Use GX Works3 for programming with the MELSEC iQ-F Series.

Software	GX Works3
Compatible models	MELSEC iQ-R series MELSEC iQ-F series

Main programming languages supported

The main IEC languages are supported by GX Works3. Various different programming languages can be used within the same project simultaneously and can be viewed easily via the menu tab. The labels and devices used in each program can be shared across multiple platforms, with user defined function blocks supported.

Ladder diagram

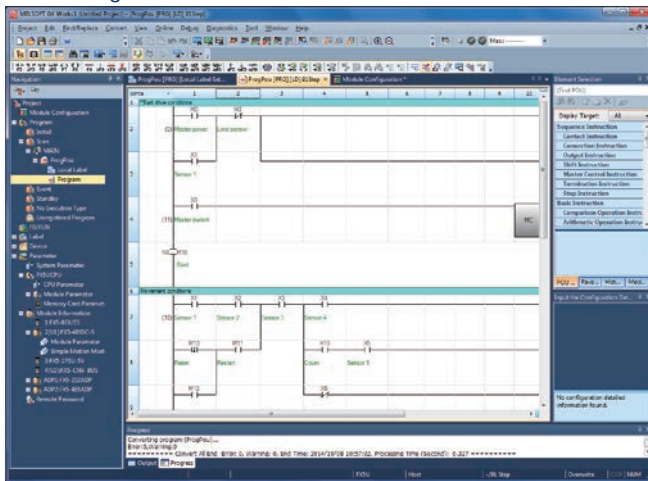

FBD/LD language

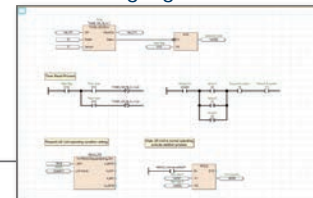

ST language

```

10 IF #0 THEN
2  S_ST001 := TRUE;
3  ELSE
4  S_ST001 := FALSE;
5  END_IF;
6
7  Inout1 := Bool1; Inout2 := X0; Inout3 := 'ABC';
8  // LDFBI Function Block
9
10 IF NOT X01 AND X02 THEN
11  IF Inout1 AND X03 THEN
12  Y01 := TRUE;
13  OUT_T(TD01, T001, 0);
14  ELSEIF NOT (Inout1 AND Inout2) THEN
15  Y11 := TRUE;
16  OUT_T(TNOT TD01, T001, 10);
17  ELSE
18  Inout1 := FALSE;
19  ROT(TRUE, TMI0);
20  END_IF;
21  OUT_EX(OR Z1, Y10);
22  ELSE
23  Y10 := FALSE;
24  Y11 := FALSE;
25
26 IF NOT X03 AND NOT X04 THEN
27  Y10 := Inout4
    
```

Reduce repetitive program tasks

With GX Works3, global labels, local labels, and module labels can be used as well as programming by devices.

Global labels can be shared between multiple programs or between other MELSOFT software. Local labels can be used in registered programs and FBs. Module labels have buffer memory information of various intelligent function modules. Therefore, programming can be done without being conscious of the buffer memory address.

Global Label Editor

Module Label

Local Label Editor

Drag & Drop

Function introduction



Programming environment

Simple and convenient parameter settings

With MELSEC iQ-F series, various device settings that conventionally had to be programmed can be input in table format.

Easily set the built-in functions as well as extension devices just by inputting values into the parameters.

The program's execution trigger can also be set with the parameters.

Functions which can be set with parameters

- CPU parameter • Ethernet port • RS-485 port
- Input response time • Expansion board • Memory card • Security
- Expansion adapter and intelligent function module
- Program parameters

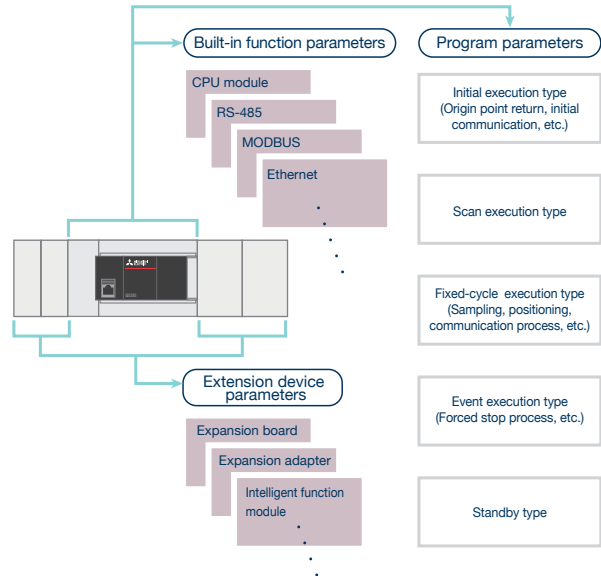

Flexible internal devices

A variety of devices including new latch relays and link relays, and expanded timers and counters are available.

The number of device points can be reassigned and used in the internal memory.

Providing the convenience of special devices

In addition to the conventional special devices, up to 12000 points of convenient system devices compatible with upper level devices are added.

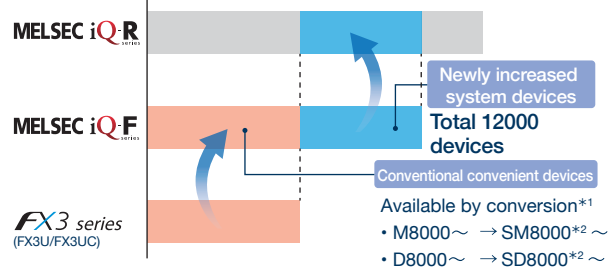

Freely customize the latch range setting

The latch range can be set for each device, so the latch clear range can be selected during the clearing operation.

Item	Symbol	Device		Latch (1)	Latch (2)
		Points	Range		
Input	X	1024	0 to 1777		
Output	Y	1024	0 to 1777		
Internal Relay	M	7680	0 to 7679	Setting	No Setting
Link Relay	B	256	0 to FF	No Setting	No Setting
Special Link Relay SB		256	0 to FF		
Annunciator	F	128	0 to 127	No Setting	No Setting
Step Relay	S	4096	0 to 4095	Setting	
Timer	T	512	0 to 511	No Setting	No Setting
Retentive Timer	ST	16	0 to 15	Setting	No Setting
Counter	C	256	0 to 255	Setting	No Setting
Long Counter	LC	64	0 to 63	Setting	No Setting
Data Register	D	8000	0 to 7999	Setting	No Setting
Latch Relay	L	7680	0 to 7679		
Area Capacity			12.0K Word		11.0K Word
Total Device			11.1K Word		9.6K Word
Total Word Device			10.2K Word		8.1K Word
Total Bit Device			15.7K Bit		25.1K Bit

Handy timer and counter settings

The timer and counter properties are determined by data type and how instruction is written, so programs can be created regardless of the device number.

Timers	
OUT T0	100 ms timer
OUTH T0	10 ms timer
OUTHS T0	1 ms timer

Counters	
OUT C0	16 bits counter
OUT LC0	32 bits counter

Retentive timers	
OUT ST0	100 ms retentive timer
OUTH ST0	10 ms retentive timer
OUTHS ST0	1 ms retentive timer

*1: When the FX3U/FX3UC project created with GX Works2 is used for the MELSEC iQ-F series, the device will be converted automatically.

*2: Some device names and device numbers may differ.

Driving simulation

With GX Simulator3, programs can be debugged with a virtual PLC on the computer. It is convenient to be able to check before operating on the real machine.

CPU module simulation

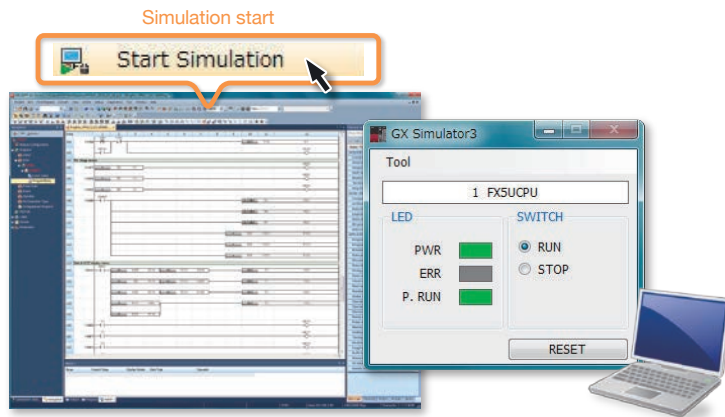

Even without a real machine,
the cooperation of
CPU module
+ simple motion
can be verified!

Simple motion simulation*

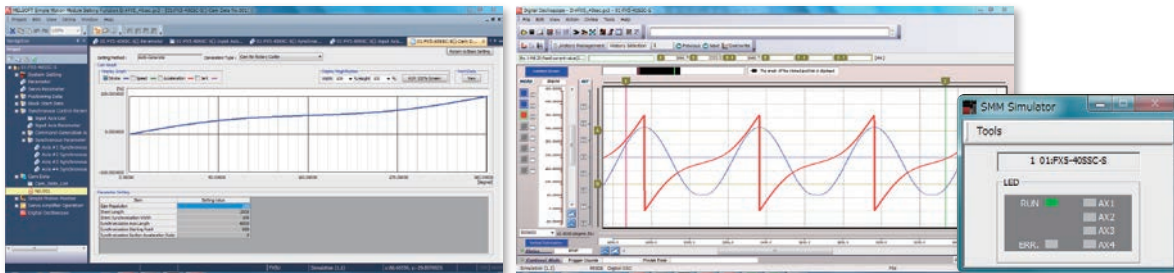

It is possible to check the operation even if there is no real machine. Simulation can be done without going to the site, which leads to a reduction in man-hours for programming.

Even without a servomotor or amplifier, it is possible to check operation closer to actual machine tests.

Integrated simple motion setup tool

GX Works3 is equipped with a simple motion setup tool that makes it easy to change simple motion module settings such as module parameters, positioning data and servo parameters. Also, the servo adjustment is simplified using it.

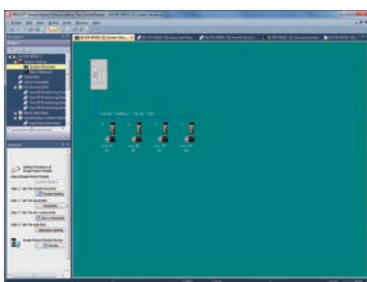

System Configuration

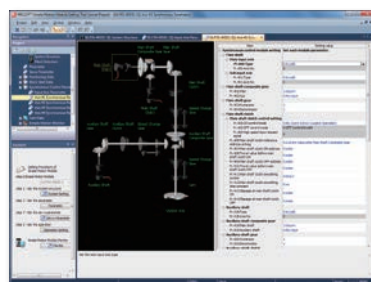

Synchronized Control Parameter

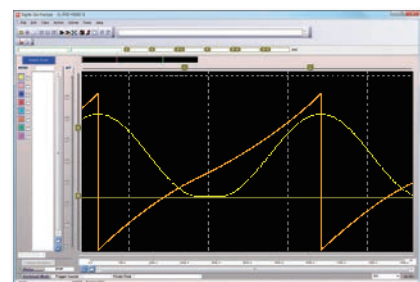

Digital Oscilloscope

*: Supported by GX Works3 Ver. 1.035M or later.

Function introduction



Programming environment

Dramatically more dedicated instructions

Compared with the FX3 series, a significant number of dedicated instructions have been added.

[FX3 series] 510 dedicated instructions → [MELSEC iQ-F series] Expanded to 1113 dedicated instructions*1

The newly added instructions include convenient ones that are interchangeable with the MELSEC iQ-R and dedicated instructions for built-in functions.
(Only FX3U and FX3UC programs can be imported)

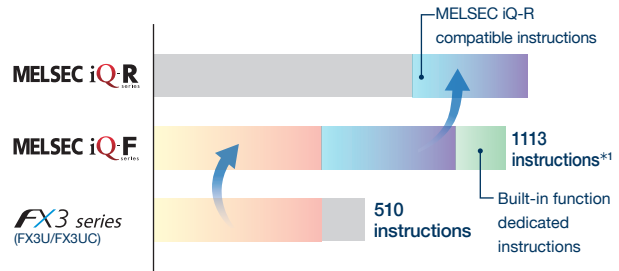

Intuitive and easy-to-understand arithmetic operations

Symbols can be input in the arithmetic operations making it easy and intuitive to describe programs.

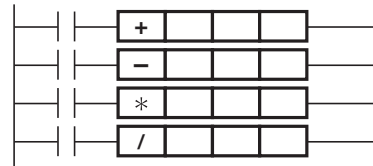

High-performance built-in high-speed counter function

Parameter setting enables input/measurement in three modes. It is possible to set 32 high-speed comparison tables*2 and 128 multi-point output high-speed comparison tables. In addition, the DHCMOV instruction can read the latest value to the special register.

- Normal mode
- Pulse density measurement mode
- Rotation speed measurement mode

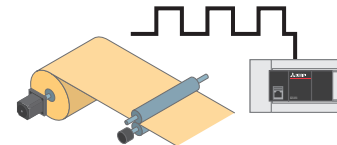

Reinforced built-in positioning function

Positioning can be easily performed with table operation instructions. Even advanced positioning like simple linear interpolation is possible with the multi-table operation (DRVTBL) instruction and multi-axis table operation (DRVMUL) instruction.

Diverse table operation settings for multi-speed and interrupt positioning, etc.

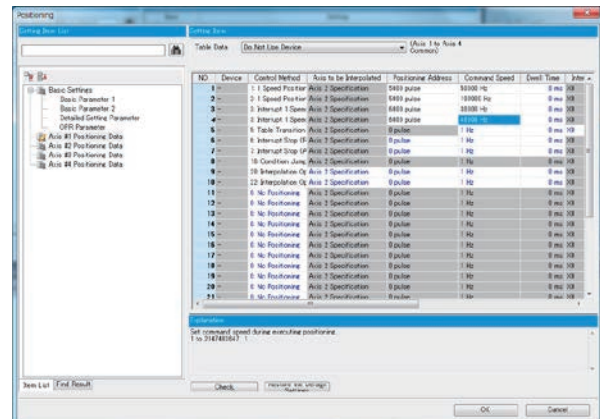

*1: When using FX5U/FX5UC Ver. 1.110.

*2: Supported by FX5U/FX5UC Ver. 1.040 or later and product number 158**** or later.

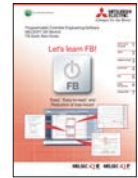

For details, refer to the catalog on the right.
L(NA)08475ENG

MELSOFT Library useful for reducing man-hours

Since module FBs* (FBs for our equipment) are all shipped with GX Works3, many libraries can be used for programming right after installation.

Module FBs* to control each module are prepared.

“Module FB*” is a componentized program that controls each module.

Using the module FBs* eliminates the need for programming the processing of each module and reduces programming man-hours.

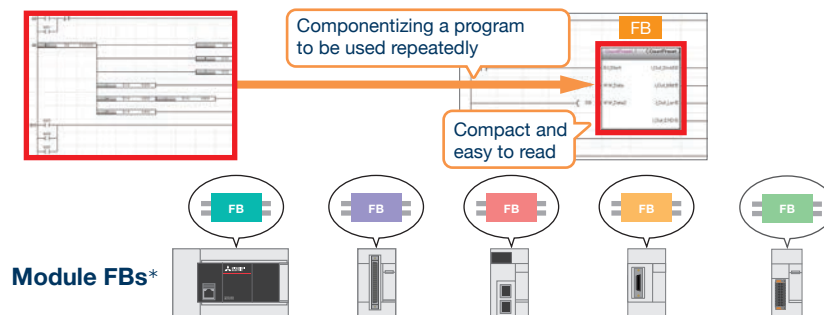

Module FBs* are included in GX Works3 in advance.

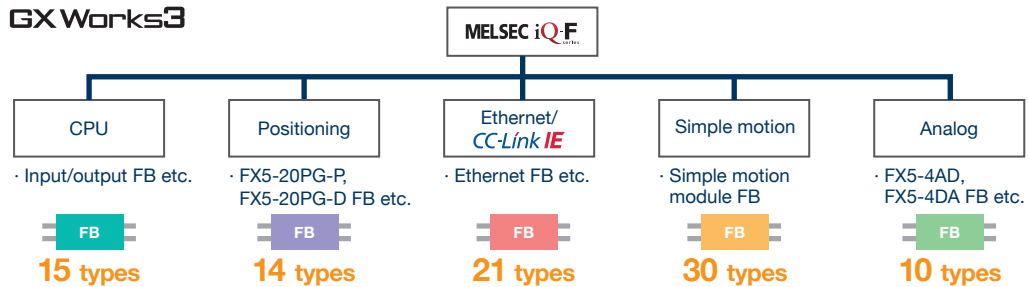

*: For details, refer to FB reference manuals of each product.

System Configuration

FX5U

Flagship model equipped with advanced built-in functions and diverse expandability

FX5U is equipped with analog functions, communication and high-speed I/O, and can easily be expanded with expansion boards and adapters. The high-speed system bus communication brings out the maximum performance of extension devices equipped with intelligent functions.

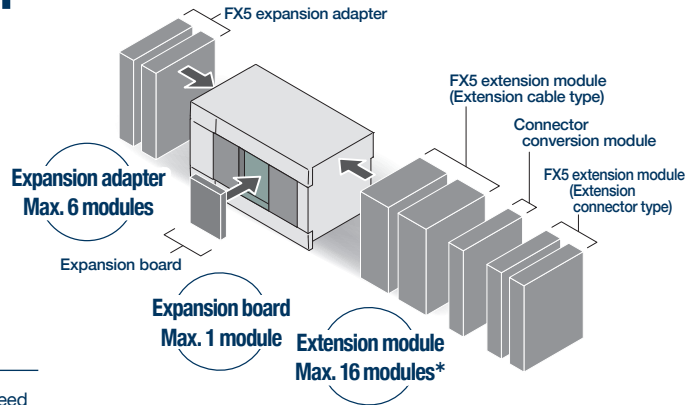

*: Up to 12 modules can be used by directly connecting a CPU module. Up to 16 modules can be used by connecting a powered I/O module or an extension power supply module. Extension power supply modules and connector conversion modules are not included in the number of connected modules.

FX5 expansion adapters



Max. 2 modules

For Communication

FX5-232ADP	For RS-232C communication
FX5-485ADP	For RS-485 communication



Max. 4 modules

Analog

FX5-4AD-ADP	For analog input
FX5-4DA-ADP	For analog output
FX5-4AD-PT-ADP	For resistance temperature detector input
FX5-4AD-TC-ADP*	For thermocouple input

FX5 expansion boards



Max. 1 module

For Communication

FX5-232-BD	For RS-232C communication
FX5-485-BD	For RS-485 communication
FX5-422-BD-GOT	For RS-422 communication (For GOT connection)

Peripheral device

HMI

GOT2000, GOT1000

FX5U CPU module



FX5U-32MR/ES	AC	D2	R
FX5U-32MT/ES	AC	D2	T1
FX5U-32MT/ESS	AC	D2	T2
FX5U-32MR/DS	DC	D2	R
FX5U-32MT/DS	DC	D2	T1
FX5U-32MT/DSS	DC	D2	T2

Input: 16 points/Output: 16 points



FX5U-64MR/ES	AC	D2	R
FX5U-64MT/ES	AC	D2	T1
FX5U-64MT/ESS	AC	D2	T2
FX5U-64MR/DS	DC	D2	R
FX5U-64MT/DS	DC	D2	T1
FX5U-64MT/DSS	DC	D2	T2



Input: 32 points/Output: 32 points



FX5U-80MR/ES	AC	D2	R
FX5U-80MT/ES	AC	D2	T1
FX5U-80MT/ESS	AC	D2	T2
FX5U-80MR/DS	DC	D2	R
FX5U-80MT/DS	DC	D2	T1
FX5U-80MT/DSS	DC	D2	T2

Input: 40 points/Output: 40 points

Option

Terminal module	I/O cable	Extended extension cable												
 <table border="0" style="width: 100%;"> <tr> <td>FX-16E-TB</td> <td>FX-16E-TB/UL</td> </tr> <tr> <td>FX-32E-TB</td> <td>FX-32E-TB/UL</td> </tr> <tr> <td>FX-16EYR-TB</td> <td>FX-16EYR-ES-TB/UL</td> </tr> <tr> <td>FX-16EYS-TB</td> <td>FX-16EYS-ES-TB/UL</td> </tr> <tr> <td>FX-16EYT-TB</td> <td>FX-16EYT-ES-TB/UL</td> </tr> <tr> <td></td> <td>FX-16EYT-ESS-TB/UL</td> </tr> </table>	FX-16E-TB	FX-16E-TB/UL	FX-32E-TB	FX-32E-TB/UL	FX-16EYR-TB	FX-16EYR-ES-TB/UL	FX-16EYS-TB	FX-16EYS-ES-TB/UL	FX-16EYT-TB	FX-16EYT-ES-TB/UL		FX-16EYT-ESS-TB/UL	 <ul style="list-style-type: none"> ● General-purpose input/output cable FX-16E-500CAB-S (5 m, 20-pin single wires) ● For terminal module FX-16E-□CAB (20-pin on both ends) □: 150 (1.5 m) / 300 (3 m) / 500 (5 m) ● For terminal module FX-16E-□CAB-R (20-pin on both ends) □: 150 (1.5 m) / 300 (3 m) / 500 (5 m) 	 <ul style="list-style-type: none"> ● Extended extension cable FX5-30EC*
FX-16E-TB	FX-16E-TB/UL													
FX-32E-TB	FX-32E-TB/UL													
FX-16EYR-TB	FX-16EYR-ES-TB/UL													
FX-16EYS-TB	FX-16EYS-ES-TB/UL													
FX-16EYT-TB	FX-16EYT-ES-TB/UL													
	FX-16EYT-ESS-TB/UL													
Engineering tool	Battery													
GX Works3	FX3U-32BL													
Connector for external devices														
<ul style="list-style-type: none"> ● Soldering type (straight out)*7 A6CON1 (40-pin) ● Crimping type (straight out)*7 A6CON2 (40-pin) ● Soldering type (straight/diagonal out)*7 A6CON4 (40-pin) 														
<ul style="list-style-type: none"> Connectors for self-making I/O cables ● For flat cables FX2C-I/O-CON (0.1 mm², 20-pin) ● Connector for single wires FX2C-I/O-CON-S (0.3 mm², 20-pin) FX2C-I/O-CON-SA (0.5 mm², 20-pin) FX-I/O-CON2-S (0.3 mm², 40-pin)*8 FX-I/O-CON2-SA (0.5 mm², 40-pin)*8 														
Power supply cable	SD memory card													
<ul style="list-style-type: none"> ● Power supply cable FX2NC-100BPCB (1 m) ● Power crossover cable FX2NC-10BPCB1 (0.1 m) 	<ul style="list-style-type: none"> NZ1MEM-2GBSD (2 GB) NZ1MEM-4GBSD (4 GB) NZ1MEM-8GBSD (8 GB) NZ1MEM-16GBSD (16 GB) 													

AC	AC power supply	T1	Transistor output (sink)
DC	DC power supply	T2	Transistor output (source)
D2	DC input (sink/source)	R	Relay output

Connector connection
 Cable connection

★ : New product





Outline Specifications



Item		Outline Specifications
Power supply	Rated voltage	AC power supply type: 100 to 240 V AC, 50/60 Hz DC power supply type: 24 V DC
	Power consumption*1	AC power supply type: 30 W (32M), 40 W (64M), 45 W (80M) DC power supply type: 30 W (32M), 40 W (64M), 45 W (80M)
	Rush current	AC power supply type: 32M: max. 25 A for 5 ms or less/100 V AC, max. 50 A for 5 ms or less/200 V AC 64M/80M: max. 30 A for 5 ms or less/100 V AC, max. 60 A for 5 ms or less/200 V AC DC power supply type: 32M: max. 50 A for 0.5 ms or less/24 V DC 64M/80M: max. 65 A for 2.0 ms or less/24 V DC
	5 V DC internal power supply capacity	AC power supply type: 900 mA (32M), 1100 mA (64M/80M) DC power supply type: 900 mA (775 mA)*2 (32M), 1100 mA (975 mA)*2 (64M/80M)
	24 V DC service power supply capacity	AC power supply type: 400 mA [300 mA*3] (32M), 600 mA [300 mA*3] (64M/80M) When an external power supply is used for the input circuit of the CPU module: 480 mA [380 mA*3] (32M), 740mA [440 mA*3] (64M), 770 mA [470 mA*3] (80M)
	24 V DC internal power supply capacity	DC power supply type: 480 mA (360 mA)*2 (32M), 740 mA (530 mA)*2 (64M), 770 mA (560 mA)*2 (80M)
Input/output	Input specifications	5.3 mA/24 V DC (X020 and later: 4.0 mA/24 V DC)
	Output specifications	Relay output type: 2 A/1 point, 8 A or less/4 points common, 8 A or less/8 points common, 30 V DC or less, 240 V AC or less (250 V AC or less in case of noncompliance with CE, UL/cUL Standards) Transistor output type: 0.5 A/1 point, 0.8 A or less/4 points common, 1.6 A or less/8 points common, 5 to 30 V DC
	Input/output extension	Extension devices for FX5 can be connected: when adding an extension connector type, the connector conversion module (FX5-CNV-IF) is required.
Built-in communication port		Ethernet (100BASE-TX/10BASE-T), RS-485 1 ch each
Built-in memory card slot		1 slot for SD memory card
Built-in analog input/output		Input 2 ch, output 1 ch

*1: The values show the state where the service power of 24 V DC is consumed to the maximum level in case that its configuration has the max. no. of connections provided to CPU module. (Including the current in the input circuit)
*2: The values in the parentheses () indicate the power supply capacity to be resulted when the power supply voltage falls in the range from 16.8 to 19.2 V DC.
*3: The values in the brackets [] will result when the ambient temperature is less than 0°C during operations.

Please choose the I/O type of CPU module or I/O module suited for your equipment. Refer to the page below for the details of I/O type of each product.

FX5 extension module (Cable type)

I/O module	Intelligent function module	Extension power supply module
 <p>Powered I/O module FX5-32ER/ES*3 FX5-32ET/ES*3 FX5-32ET/ESS*3 FX5-32ER/DS*4 FX5-32ET/DS*4 FX5-32ET/DSS*4</p> <p>Input module FX5-8EX/ES FX5-16EX/ES Output module FX5-8EYR/ES FX5-8EYT/ES FX5-8EYT/ESS FX5-16EYR/ES FX5-16EYT/ES FX5-16EYT/ESS</p> <p>I/O module FX5-16ER/ES FX5-16ET/ES FX5-16ET/ESS High-speed pulse input/output module FX5-16ET/ES-H FX5-16ET/ESS-H</p>	 <p>Analog FX5-4AD FX5-4DA FX5-8AD Temperature control FX5-4LC</p> <p>Positioning FX5-20PG-P ★ FX5-20PG-D Simple motion FX5-40SSC-S FX5-80SSC-S </p> <p>Communication/network ★ FX5-ENET CC-Link IE Field Basic ★ FX5-ENET/IP FX5-CCLIEF CC-Link IE V2 FX5-CCL-MS CC-Link V2 FX5-ASL-M AnyWireASLINK ★ FX5-DP-M</p>	 <p>Extension power supply module FX5-1PSU-5V*3</p>

FX5 extension module (Extension cable type)	FX5 extension module (Extension connector type)	Bus conversion module	FX3 extension module																		
<p>Connector conversion module FX5-CNV-IF</p> 	<p>I/O module</p> <p>Input module FX5-C16EX/D*9 FX5-C16EX/DS FX5-C32EX/D*9 FX5-C32EX/DS FX5-C32EX/DS-TS*6</p> <p>Output module FX5-C16EYT/D FX5-C16EYT/DSS ★ FX5-C16EYR/D-TS*6 FX5-C32EYT/D FX5-C32EYT/DSS FX5-C32EYT/D-TS*6 FX5-C32EYT/DSS-TS*6</p> <p>Input/output module FX5-C32ET/D*9 FX5-C32ET/DSS FX5-C32ET/DS-TS*6 FX5-C32ET/DSS-TS*6</p>	<p>Extension power supply module FX5-C1PS-5V*1*4</p> 	<p>Intelligent function module</p> <table border="1"> <tr> <td>Analog</td> <td>Positioning</td> </tr> <tr> <td>FX3U-4AD For input FX3U-4DA For output</td> <td>FX3U-1PG For pulse output</td> </tr> <tr> <td>Temperature control</td> <td>High speed counter</td> </tr> <tr> <td>FX3U-4LC Temperature control</td> <td>FX3U-2HC For high-speed input</td> </tr> <tr> <td colspan="2">Communication/Network</td> </tr> <tr> <td>FX3U-64CCL</td> <td>CC-Link slave</td> </tr> <tr> <td>FX3U-16CCL-M</td> <td>CC-Link master</td> </tr> <tr> <td>FX3U-128ASL-M</td> <td>AnyWireASLINK master</td> </tr> <tr> <td>FX3U-32DP</td> <td>PROFIBUS-DP slave</td> </tr> </table> <p>For the module requiring parameter in FX3 extension module, parameter settings by program are necessary. When connecting the FX3 extension module, the bus speed for FX3 applies for access.</p> <p>Extension power supply module FX3U-1PSU-5V*1</p> 	Analog	Positioning	FX3U-4AD For input FX3U-4DA For output	FX3U-1PG For pulse output	Temperature control	High speed counter	FX3U-4LC Temperature control	FX3U-2HC For high-speed input	Communication/Network		FX3U-64CCL	CC-Link slave	FX3U-16CCL-M	CC-Link master	FX3U-128ASL-M	AnyWireASLINK master	FX3U-32DP	PROFIBUS-DP slave
Analog	Positioning																				
FX3U-4AD For input FX3U-4DA For output	FX3U-1PG For pulse output																				
Temperature control	High speed counter																				
FX3U-4LC Temperature control	FX3U-2HC For high-speed input																				
Communication/Network																					
FX3U-64CCL	CC-Link slave																				
FX3U-16CCL-M	CC-Link master																				
FX3U-128ASL-M	AnyWireASLINK master																				
FX3U-32DP	PROFIBUS-DP slave																				

*1: When adding the extension module, it is necessary to connect it to the front stage of extension module in case of a shortage of internal power supply in CPU module.
*2: Attach when connecting an extension cable type module to a distant location or when making two-tier connections. The connector conversion adapter (FX5-CNV-BO) is required when connected with an input/output module (extension cable type), high-speed pulse input/output module, or an intelligent function module. When using also the bus conversion module in the same system, connect the FX5 extension power supply module or the powered I/O module right after the extended extension cable.
*3: Can be connected only to the AC power type system.
*4: Can be connected only to the DC power type system.
*5: There are restrictions on the number of extension devices and the connection order of FX5-4AD-TC-ADP. For details, refer to the manual.
*6: Spring clamp terminal block type.
*7: For FX5-20PG-P and FX5-20PG-D.
*8: For FX3U-2HC.
*9: FX2NC-100BPCB is required separately when adding to FX5U.

System Configuration

FX5UC

Contributing to miniaturization of equipment by condensing various functions on a compact body

The extension module compatible with FX5UC is compact and easy-to-use, and helps to downsize your system. Easily connect to the FX5 and FX3 extension modules with the variety of conversion modules available.

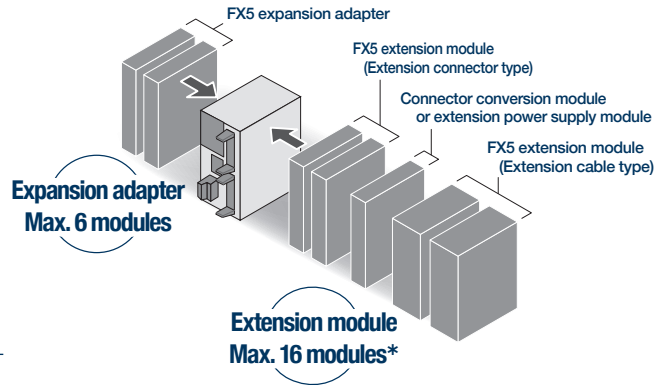

*: Up to 12 modules can be used by directly connecting a CPU module. Up to 16 modules can be used by connecting a powered I/O module or an extension power supply module. Extension power supply modules and connector conversion modules are not included in the number of connected modules.

FX5 expansion adapter



Max. 2 modules

For Communication

FX5-232ADP For RS-232C communication
FX5-485ADP For RS-485 communication



Max. 4 modules

Analog

FX5-4AD-ADP For analog input
FX5-4DA-ADP For analog output
FX5-4AD-PT-ADP For resistance temperature detector input
FX5-4AD-TC-ADP* For thermocouple input

FX5UC CPU module



FX5UC-32MT/D
FX5UC-32MT/DSS
FX5UC-32MT/DS-TS*5
FX5UC-32MR/DS-TS*5

★ FX5UC-32MR/DS-TS*5

Input: 16 points/Output: 16 points



FX5UC-64MT/D
FX5UC-64MT/DSS

Input: 32 points/Output: 32 points



FX5UC-96MT/D
FX5UC-96MT/DSS

Input: 48 points/Output: 48 points

FX5 extension module (extension connector type)

I/O module



Input module

FX5-C16EX/D*9
FX5-C16EX/DS
FX5-C32EX/D*9
FX5-C32EX/DS
FX5-C32EX/DS-TS*5

Output module

FX5-C16EYT/D
FX5-C16EYT/DSS
★ FX5-C16EYR/D-TS*5
FX5-C32EYT/D
FX5-C32EYT/DSS
FX5-C32EYT/DS-TS*5
FX5-C32EYT/DSS-TS*5

I/O module

FX5-C32ET/D*9
FX5-C32ET/DSS
FX5-C32ET/DS-TS*5
FX5-C32ET/DSS-TS*5





Peripheral device

HMI

GOT2000, GOT1000

<p>DC DC power supply</p> <p>D1 DC input (sink)</p> <p>D2 DC input (sink/source)</p>	<p>T1 Transistor output (sink)</p> <p>T2 Transistor output (source)</p> <p>R Relay output</p>
<p> Connector connection</p> <p> Cable connection</p> <p>★: New product</p>	

Option

Terminal module	I/O cable	Power supply cable	Extended extension cable	Connector for external devices
 <p>FX-16E-TB FX-32E-TB FX-16EYR-TB FX-16EYS-TB FX-16EYT-TB FX-16E-TB/UL FX-32E-TB/UL FX-16EYR-ES-TB/UL FX-16EYS-ES-TB/UL FX-16EYT-ES-TB/UL FX-16EYT-ESS-TB/UL</p>	 <p>● General-purpose input/output cable FX-16E-500CAB-S (5 m, 20-pin single wires)</p> <p>● For terminal module FX-16E-CAB (20-pin on both ends) □: 150 (1.5 m) / 300 (3 m) / 500 (5 m)</p> <p>● For terminal module FX-16E-□CAB-R (20-pin on both ends) □: 150 (1.5 m) / 300 (3 m) / 500 (5 m)</p>	<p>● Power cable for CPU modules FX2NC-100MPCB (1 m) (Attached to CPU module and intelligent function module*)</p> <p>● Power supply cable FX2NC-100BPCB (1 m) (Attached to FX5UC-□MT/D)</p> <p>● Power crossover cable FX2NC-10BPCCB1 (0.1 m) (Attached to FX5-C□EX/D and FX5-C32ET/D)</p>	 <p>● Extended extension cable FX5-30EC*3 FX5-65EC*3</p>  <p>● Connector conversion adapter FX5-CNV-BC</p>	<p>● Soldering type (straight out)*6 A6CON1 (40-pin)</p> <p>● Crimping type (straight out)*6 A6CON2 (40-pin)</p> <p>● Soldering type (straight/diagonal out)*6 A6CON4 (40-pin)</p> <p>Connectors for self-making I/O cables</p> <p>● For flat cables FX2C-I/O-CON (0.1 mm², 20-pin)</p> <p>● Connector for single wires FX2C-I/O-CON-SA (0.3 mm², 20-pin) FX2C-I/O-CON-S (0.5 mm², 20-pin) FX-I/O-CON2-S (0.3 mm², 40-pin)*8 FX-I/O-CON2-SA (0.5 mm², 40-pin)*8</p>
Engineering tool	Battery	SD memory card		
GX Works3	FX3U-32BL	NZ1MEM-2GBSD (2 GB) NZ1MEM-4GBSD (4 GB)	NZ1MEM-8GBSD (8 GB) NZ1MEM-16GBSD (16 GB)	

Outline Specifications

Item	Outline Specifications	
Power supply	Rated supply voltage	24 V DC
	Power consumption*1	32M: 5 W/24 V DC (30 W/24 V DC +20%, -15%) 64M: 8 W/24 V DC (33 W/24 V DC +20%, -15%) 96M: 11 W/24 V DC (36 W/24 V DC +20%, -15%)
	Rush current	32M: Max. 35 A 0.5 ms or less/24 V DC 64M/96M: Max. 40 A 0.5 ms or less/24 V DC
	5 V DC power supply capacity	720 mA
Input/output	24 V DC power supply capacity	500 mA
	Input specifications	5.3 mA/24 V DC (X020 and later: 4.0 mA/24 V DC)
	Output specifications	Relay output type: 2 A/1 point or less, 4 A or less/8 points common*2 30 V DC or less, 240 V AC or less (250 V AC or less in case of noncompliance with CE, UL/cUL Standards) Transistor output type: Y000 to Y003 0.3 A/1 point, Y004 and later 0.1 A/1 point, 0.8 A/8 points common*3 5 to 30 V DC
	Input/output extension	Extension device for FX5 can be connected (extension power supply module (FX5-C1PS-5V) or connector conversion module (FX5-CNV-IFC) is required when connecting an extension cable type)
Built-in communication port	Ethernet (100BASE-TX/10BASE-T), RS-485 1 ch each	
Built-in memory card slot	1 slot for SD memory card	

*1: The values show the state where the power of 24 V DC is consumed to the maximum level in case that its configuration has the max. no. of connections provided to CPU module. (Including the current in an input circuit)
*2: 8 A or less when two common terminals are connected to the external part.
*3: 1.6 A or less when two common terminals are connected to the external part.

FX5 extension module (extension connector type)

FX5 extension module (extension cable type)

Please choose the I/O type of CPU module or I/O module suited for your equipment. Refer to the page below for the details of I/O type of each product.

Extension power supply module



Extension power supply module
FX5-C1PS-5V*1 *2

or

Connector conversion module



Connector conversion module
FX5-CNV-IFC

I/O module

Powered I/O module

FX5-32ER/DS
FX5-32ET/DS
FX5-32ET/DSS

Input module

FX5-8EX/ES
FX5-16EX/ES

Output module

FX5-8EYR/ES
FX5-8EYT/ES
FX5-8EYT/ESS
FX5-16EYR/ES
FX5-16EYT/ES
FX5-16EYT/ESS

I/O module

FX5-16ER/ES
FX5-16ET/ES
FX5-16ET/ESS

High-speed pulse input/output module

FX5-16ET/ES-H
FX5-16ET/ESS-H

Intelligent function module

Analog

FX5-4AD
FX5-4DA
FX5-8AD

Temperature control

FX5-4LC

Positioning

FX5-20PG-P
★ FX5-20PG-D

Simple motion

FX5-40SSC-S
FX5-80SSC-S

SSCNET III/H

Communication/Network

★ FX5-ENET
CC-Link IE Field Basic

★ FX5-ENET/IP

FX5-CCLIEF
CC-Link IE Field

FX5-CCL-MS
CC-Link V2

FX5-ASL-M
AnyWireASLINK

★ FX5-DP-M

Bus conversion module



Bus conversion module
FX5-CNV-BUS



Bus conversion module
FX5-CNV-BUSC

FX3 extension module

Intelligent function module

Analog

FX3U-4AD For input
FX3U-4DA For output

Positioning

FX3U-1PG For pulse output

Communication/Network

FX3U-64CCL CC-Link slave
FX3U-16CCL-M CC-Link master
FX3U-128ASL-M AnyWireASLINK master
FX3U-32DP PROFIBUS-DP slave

Temperature control

FX3U-4LC Temperature control

High speed counter

FX3U-2HC For high-speed input

For the module requiring parameter in FX3 extension module, parameter settings by program are necessary. When connecting the FX3 extension module, the bus speed for FX3 applies for access.

*1: When adding the extension module, it is necessary to connect it to the front stage of extension module in case of a shortage of internal power supply in CPU module.
*2: Next-stage extension connector of an extension power supply module can be used only for either connector connection or cable connection. In case of connector connection, an extension connector type module can be connected.
*3: Attach when connecting an extension cable type module to a distant location or when making two-tier connections. The connector conversion adapter (FX5-CNV-BC) is required when connected with an input/output module (extension cable type) or an intelligent function module. When using also the bus conversion module in the same system, connect the powered I/O module right after the extended extension cable.
*4: There are restrictions on the number of extension devices and the connection order of FX5-4AD-TC-ADP. For details, refer to the manual.
*5: Spring clamp terminal block type.
*6: For FX5-20PG-P and FX5-20PG-D.
*7: There are some exception models. For details, refer to the manual.
*8: For FX3U-2HC.
*9: FX2NC-100BPCB is required separately when adding to FX5UC-□MT/DS□-TS.

Performance Specifications



■ FX5U/FX5UC CPU Module Performance Specifications

Item		Specifications
Control system		Stored-program repetitive operation
Input/output control system		Refresh system (Direct access input/output allowed by specification of direct access input/output (DX, DY))
Programming specifications	Programming language	Ladder diagram (LD), structured text (ST), function block diagram/ladder language (FBD/LD)
	Programming expansion function	Function block (FB), function (FUN), label programming (local/global)
	Constant scan	0.2 to 2000 ms (can be set in 0.1 ms increments)
	Fixed cycle interrupt	1 to 60000 ms (can be set in 1 ms increments)
	Timer performance specifications	100 ms, 10 ms, 1 ms
	No. of program executions	32
Operation specifications		Execution type: Standby type, initial execution type, scan execution type, fixed-cycle execution type, event execution type Interrupt type: Internal timer interrupt, input interruption, high-speed comparison match interrupt, interrupt from module*1
Instruction processing time	LD X0	34 ns*2
	MOV D0 D1	34 ns*2
Memory capacity	Program capacity	64 k/128 k steps (128 kbytes/256 kbytes, flash memory)
	SD memory card	Memory card capacity (SD/SDHC memory card: Max. 16 Gbytes)
	Device/label memory	120 kbytes
	Data memory/standard ROM	5 Mbytes
Flash memory (Flash ROM) write count		Max. 20000 times
File storage capacity	Device/label memory	1
	Data memory	
	P: No. of program files FB: No. of FB files	P: 32, FB: 16
	SD memory card	2 Gbytes: 511*4, 4 G/8 G/16 Gbytes: 65534*4
Clock function	Display data	Year, month, day, hour, minute, second, day of week (leap year automatic detection)
	Precision	Monthly difference: ±45 sec at 25°C (77°F) (typical value)
No. of input/output points	(1) No. of input/output points	256 points or less/384 points or less*3
	(2) No. of remote I/O points	384 points or less/512 points or less*3
	Total No. of points of (1) and (2)	512 points or less
Power failure retention (Clock data*5)	Retention method	Large-capacity capacitor
	Retention time	10 days (Ambient temperature: 25°C (77°F))
Power failure retention (Device)	Capacity for power failure retention	12 K words maximum*6

*1: Interrupt from the intelligent function module and high-speed pulse input/output module.

*2: When the program capacity is 64 k steps.

*3: Supported by FX5U/FX5UC Ver. 1.100 or later and by GX Works3 Ver. 1.047Z or later.

*4: The value listed above indicates the number of files stored in the root folder.

*5: Clock data is retained using the power accumulated in a large-capacity capacitor incorporated into the PLC. When voltage of the large-capacity capacitor drops, clock data is no longer accurately retained. The retention period of a fully charged capacitor (electricity is conducted across the PLC for at least 30 minutes) is 10 days (ambient temperature: 25°C (77°F)). How long the capacitor can hold the data depends on the operating ambient temperature. When the operating ambient temperature is high, the holding period is short.

*6: All devices in the (high-speed) device area can be held against power failure. Devices in the (standard) device area can be held also when the optional battery is mounted.

■ Number of device points

Item		Base	Max. number of points	
No. of user device points	Input relay (X)	8	1024 points or less	
	Output relay (Y)	8	1024 points or less	
	Internal relay (M)	10	32768 points (can be changed with parameter)*2	
	Latch relay (L)	10	32768 points (can be changed with parameter)*2	
	Link relay (B)	16	32768 points (can be changed with parameter)*2	
	Annunciator (F)	10	32768 points (can be changed with parameter)*2	
	Link special relay (SB)	16	32768 points (can be changed with parameter)*2	
	Step relay (S)	10	4096 points (fixed)	
	Timer system	Timer (T)	10	1024 points (can be changed with parameter)*2
		Accumulation timer system	Accumulation timer (ST)	10
	Counter system	Counter (C)	10	1024 points (can be changed with parameter)*2
		Long counter (LC)	10	1024 points (can be changed with parameter)*2
	Data register (D)	10	8000 points (can be changed with parameter)*2	
	Link register (W)	16	32768 points (can be changed with parameter)*2	
	Link special register (SW)	16	32768 points (can be changed with parameter)*2	
	No. of system device points	Special relay (SM)	10	10000 points (fixed)
Special register (SD)		10	12000 points (fixed)	
Module access device	Intelligent function module device	10	65536 points (designated by U□\G□)	
No. of index register points	Index register (Z)*3	10	24 points	
	Long index register (LZ)*3	10	12 points	
No. of file register points	File register (R)	10	32768 points (can be changed with parameter)*2	
	Extended file register (ER)	10	32768 points (are stored in SD memory card)	
No. of nesting points	Nesting (N)	10	15 points (fixed)	
	Pointer (P)	10	4096 points	
No. of pointer points	Interrupt pointer (I)	10	178 points (fixed)	
	Others	Decimal constant (K)	Signed	16 bits: -32768 to +32767, 32 bits: -2147483648 to +2147483647
Unsigned			16 bits: 0 to 65535, 32 bits: 0 to 4294967295	
Hexadecimal constant (H)		—	16 bits: 0 to FFFF, 32 bits: 0 to FFFFFFFF	
Real constant (E)		Single precision	—	E-3.40282347+38 to E-1.17549435-38, 0, E1.17549435-38 to E3.40282347+38
Character string	—	—	Shift-JIS code max. 255 single-byte characters (256 including NULL)	

*1: Supported by FX5U/FX5UC Ver. 1.100 or later and by GX Works3 Ver. 1.047Z or later.

*2: Can be changed with parameters within the capacity range of the CPU built-in memory.

*3: Total of the index register (Z) and long index register (LZ) is maximum 24 words.

New products

New product information

Introducing new relay output spring clamp terminal block type FX5UC CPU modules and I/O modules. They can save the labor of processing electric wires, and you can wire quickly and easily.

NEW

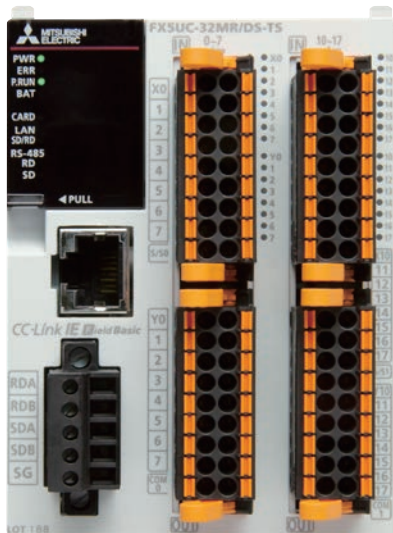

NEW



A relay output type is newly released!

CPU module 32 points

FX5UC-32MR/DS-TS DC D2 R

DC DC power supply R Relay output
D2 DC input (sink/source)

I/O module*1 16 points

FX5-C16EYR/D-TS

Output module

What is a spring clamp terminal block type?

Spring clamp terminals hold wires in place by the force of internal springs. Constant force holds wires in place, preventing wires from falling out due to vibration.

<Internal construction>

Securely fixed by elastic force!

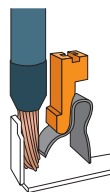

What are the advantages?

There is no need for crimp terminals or crimp tools! Wiring is possible without extra time or cost!

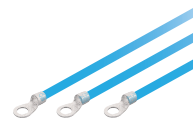

Attaching crimp terminals to cables one by one is tedious!



No need for crimp terminals or crimp tools! Just prepare the cables!

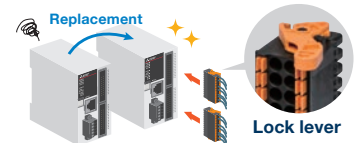

No external terminal is needed! Easily detachable & securely fixed by a lock lever!
 With detachable terminals, the change of wiring is not needed even when replacing the modules!

With spring clamp terminals block type, wiring is complete in 3 steps!

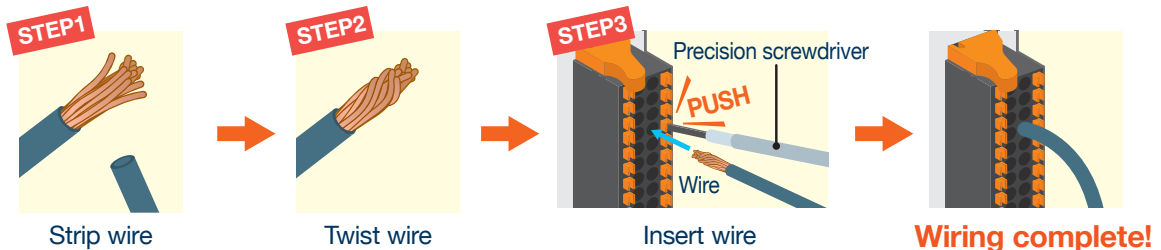

For ferrule terminals, the following is introduced. (Reference product: PHOENIX CONTACT GmbH & Co. KG^{*)}

Model	Type	
CRIMPFOX 6	Crimp tool	
AI 0.5-10 WH	Crimp terminal	Wire size 0.5 mm ²
AI 0.75-10 GY	(Ferrule with insulation sleeve)	Wire size 0.75 mm ²
A 1.0-10	Crimp terminal	Wire size 1.0 mm ²
A 1.5-10	(Ferrule without insulation sleeve)	Wire size 1.5 mm ²

Additionally!

By using a ferrule terminal, wiring can be completed just by inserting with the push-in method.

Complete wiring smoothly, even in a confined panel.

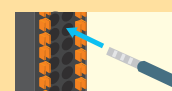

*1: When connecting to FX5U CPU module, FX5-CNV-IF is required.

*2: If the product other than the reference product is used, the wire ferrule cannot be pulled out. Sufficiently confirm that the wire ferrule can be pulled out before use.

FUTURE MANUFACTURING

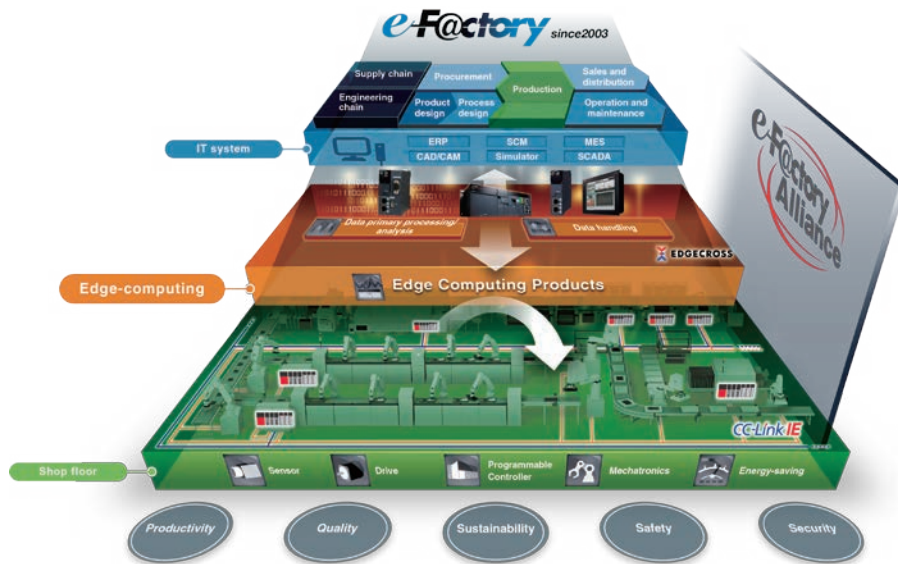

The Future of Manufacturing as envisioned by Mitsubishi Electric, e-F@ctory: “Manufacturing” that evolves in response to environmental changes in an IoT enabled world.

Established In 2003, e-F@ctory created a Kaizen^{#1} automation methodology to help optimize and manage the increasingly complex business of “manufacturing”. Continuously evolving itself, it also utilizes the expanded reach of IT, which has brought “cyber world” benefits of analysis, simulation and virtual engineering, and yet has also placed greater demands on the “physical” world for increased data sensing, collection and communication. The continued success of e-F@ctory comes from understanding that each manufacturer has individual needs and investment plans but must still deliver; “Reduced management costs” (TCO); production flexibility to make a multitude of product in varying quantities; continuously enhanced quality. In short e-F@ctory’s goal is to deliver operational performance that is “a step ahead of the times”, while enabling manufacturing to evolve in

response to its environment. To do this it is supported by three key elements:

- The e-F@ctory Alliance Partners; who bring a wide range of software, devices, and system integration skills that enable the creation of the optimal e-F@ctory architecture.
- Advanced communication; utilizing open network technology like CC-Link IE, and communication middleware such as OPC, to open the door to device data, including legacy systems, while supporting high speed extraction.
- Platform thinking; to reduce the number of complex interfaces making it easier to bring together Robotics, Motion, Open programming languages (C language), PACs etc. strengthening the field of control,

yet operating on industrial strength hardware.



Table of Contents

Lineup details/model selection	44	1
I/O Module	57	2
Analog control	65	3
High speed counter	77	4
Pulse output/positioning	81	5
Network/Communication	91	6
Programming/Development Environment	119	7
Option/Related Products	123	8
Overseas service system/compatible products	131	9
Specifications	135	10
Products list	185	11

Selecting the FX5U model

◇ Product configuration

FX5U

- Control scale: 32 to 384 points (CPU module: 32/64/80 points)
- Control points up to 512 input/output points, including remote I/O*

*: For CC-Link and AnyWireASLINK

* For details about the connection positions, refer to the manual.

Type	Details	Connection details, model selection
1 CPU module	PLC with built-in CPU, power supply, input/output and program memory.	Various extension devices can be connected.
2 4 I/O module (extension cable type)	Product for extending I/O of extension cable type. Some products are powered.	Input/output can be extended to up to 256 points/384 points.*1 Up to 16 extension modules can be connected. (Extension power supply modules and connector conversion modules are not included in the number of connected modules.) Up to 4 high-speed pulse I/O modules can be connected. For details, refer to "Rules for System Configuration" on p. 49.
3 FX5 extension power supply module	Module for extending power supply if CPU module's internal power supply is insufficient. Extension cable is enclosed.	Power can be supplied to I/O module, intelligent function module, and bus conversion module. Up to 2 modules can be connected.
5 FX5 intelligent function module	Module with functions other than input/output.	Up to 16 extension modules including the I/O module can be connected (Extension power supply modules and connector conversion modules are not included in the number of connected modules.)
6 Connector conversion module	Module for connecting FX5 Series (extension connector type) extension module	An extension module (extension connector type) for FX5 can be connected.
7 I/O module (Extension connector type)	Product for adding extension connector type inputs/outputs.	The maximum number of points for input/output extension is 256 points/384 points*1. Up to 16 extension modules can be connected. (Extension power supply modules and connector conversion modules are not included in the number of connected modules.) Using this type of I/O module requires the connector conversion module.
8 Bus conversion module	Conversion module for connecting FX3 Series extension module.	FX3 extension module can be connected only to the right side of the bus conversion module. When using FX5-CNV-BUSC, a connector conversion module is required.
9 FX5 expansion board	Board connected to front of CPU module to expand functions.	Up to 1 module can be connected to the front of the CPU module. (Expansion adapter can also be used.)
10 FX5 expansion adapter	Adapter connected to left side of CPU module to expand functions.	Up to 6 modules can be connected to the left side of the CPU module.
11 FX3 extension power supply module	Module for extending power supply if CPU module's internal power supply is insufficient. Extension cable is enclosed.	Up to 2 modules can be connected. The bus conversion module is required for use.
12 FX3 intelligent function module	Module with functions other than input/output.	When using the FX3 extension power supply module, up to 8 modules*2 can be used. When not using the FX3 extension power supply module, up to 6 modules*2 can be used. The bus conversion module is required for use.

*1: Supported by FX5U CPU modules Ver. 1.100 or later and by GX Works3 Ver. 1.047Z or later.

*2: Excluding some models

1 -1) CPU module (AC power supply, DC input type)

Model	Function	Number of occupied input/output points	Power supply capacity		I/O type	No. of input points	No. of output points
			5 V DC power supply	24 V DC service power supply			
FX5U-32MR/ES	CPU module (24 V DC service power built-in)	32 points	900 mA	400 mA (480 mA*1) [300 mA (380 mA*)]*2	DC input (sink/source)/relay output	16 points	16 points
FX5U-32MT/ES					DC input (sink/source)/transistor (sink)		
FX5U-32MT/ESS					DC input (sink/source)/transistor (source)		
FX5U-64MR/ES		64 points	1100 mA	600 mA (740 mA*1) [300 mA (440 mA*)]*2	DC input (sink/source)/relay output	32 points	32 points
FX5U-64MT/ES					DC input (sink/source)/transistor (sink)		
FX5U-64MT/ESS					DC input (sink/source)/transistor (source)		
FX5U-80MR/ES		80 points	1100 mA	600 mA (770 mA*1) [300 mA (470 mA*)]*2	DC input (sink/source)/relay output	40 points	40 points
FX5U-80MT/ES					DC input (sink/source)/transistor (sink)		
FX5U-80MT/ESS					DC input (sink/source)/transistor (source)		

*1: Power supply capacity when an external power supply is used for input circuits

*2: Value inside [] indicates the power supply capacity when the CPU module is used at the operating ambient temperature of less than 0°C.

1 -2) CPU module (DC power supply/DC input type)

Model	Function	Number of occupied input/output points	Power supply capacity		I/O type	No. of input points	No. of output points
			5 V DC power supply	24 V DC power supply			
FX5U-32MR/DS	CPU module	32 points	900 mA [775 mA]*	480 mA [360 mA]*	DC input (sink/source)/relay output	16 points	16 points
FX5U-32MT/DS					DC input (sink/source)/transistor output (sink)		
FX5U-32MT/DSS					DC input (sink/source)/transistor output (source)		
FX5U-64MR/DS		64 points	1100 mA [975 mA]	740 mA [530 mA]*	DC input (sink/source)/relay output	32 points	32 points
FX5U-64MT/DS					DC input (sink/source)/transistor output (sink)		
FX5U-64MT/DSS					DC input (sink/source)/transistor output (source)		
FX5U-80MR/DS		80 points	1100 mA [975 mA]	770 mA [560 mA]*	DC input (sink/source)/relay output	40 points	40 points
FX5U-80MT/DS					DC input (sink/source)/transistor output (sink)		
FX5U-80MT/DSS					DC input (sink/source)/transistor output (source)		

*: Value inside [] indicates the power supply capacity when the supply voltage is 16.8 to 19.2 V DC.

2 -1) I/O module (AC power supply/DC input type) (extension cable type)

Model	Function	Number of occupied input/output points	Power supply capacity		I/O type	No. of input points	No. of output points
			5 V DC power supply	24 V DC service power supply			
FX5-32ER/ES*1	I/O module (24 V DC service power built-in)	32 points	965 mA	250 mA (310 mA*2)	DC input (sink/source)/relay output	16 points	16 points
FX5-32ET/ES*1					DC input (sink/source)/transistor (sink)		
FX5-32ET/ESS*1					DC input (sink/source)/transistor (source)		

*1: Can be connected only to the AC power type system

*2: Power supply capacity when an external power supply is used for input circuits

2 -2) I/O module (DC power supply/DC input type) (extension cable type)

Model	Function	Number of occupied input/output points	Power supply capacity		I/O type	No. of input points	No. of output points
			5 V DC power supply	24 V DC power supply			
FX5-32ER/DS*	I/O module	32 points	965 mA	310 mA	DC input (sink/source)/relay output	16 points	16 points
FX5-32ET/DS*					DC input (sink/source)/transistor output (sink)		
FX5-32ET/DSS*					DC input (sink/source)/transistor output (source)		

*: Can be connected only to the DC power type system

3 FX5 extension power supply module

Model	Function	Number of occupied input/output points	Power supply capacity	
			5 V DC power supply	24 V DC power supply
FX5-1PSU-5V*1	Extension power supply	—	1200 mA*3	300 mA*3
FX5-C1PS-5V*2	Extension power supply	—	1200 mA*3	625 mA*3

*1: Can be connected only to the AC power type system

*2: Can be connected only to the DC power type system

*3: Derating occurs when the ambient temperature exceeds 40°C. For details, refer to manuals of each product.

4 I/O module (extension cable type)

Model	I/O type	Number of occupied input/output points	Current consumption	
			5 V DC power supply	24 V DC power supply
FX5-8EX/ES	DC input (sink/source)	8 points	75 mA	50 mA (0 mA*2)
FX5-16EX/ES	DC input (sink/source)	16 points	100 mA	85 mA (0 mA*2)
FX5-8EYR/ES	Relay output	8 points	75 mA	75 mA
FX5-8EYT/ES	Transistor output (sink)			
FX5-8EYT/ESS	Transistor output (source)			
FX5-16EYR/ES	Relay output	16 points	100 mA	125 mA
FX5-16EYT/ES	Transistor output (sink)			
FX5-16EYT/ESS	Transistor output (source)			
FX5-16ER/ES	DC input (sink/source)/relay output	16 points	100 mA	125 mA (85 mA*2)
FX5-16ET/ES	DC input (sink/source)/transistor output (sink)			
FX5-16ET/ESS	DC input (sink/source)/transistor output (source)			
FX5-16ET/ES-H*1	DC input (sink/source)/transistor output (sink)	16 points	100 mA	125 mA (85 mA*2)
FX5-16ET/ESS-H*1	DC input (sink/source)/transistor output (source)			

*1: Supported by FX5U/FX5UC CPU modules Ver. 1.030 or later.

*2: Current consumption when an external power supply is used for input circuits.

5 FX5 intelligent function module

Model	Function	Number of occupied input/output points	Current consumption		
			5 V DC power supply	24 V DC power supply	24 V DC external power supply
FX5-4AD*1	4-ch voltage/current input	8 points	100 mA	40 mA	—
FX5-4DA*1	4-ch voltage/current output	8 points	100 mA	—	150 mA
FX5-8AD*1	8-ch voltage/current/thermocouple/resistance temperature detector input	8 points	—	40 mA	100 mA
FX5-4LC*1	4-ch temperature control (resistance temperature detector/thermocouple/micro voltage)	8 points	140 mA	—	25 mA
FX5-20PG-P*1	Pulse output for 2-axis control (transistor output)	8 points	—	—	120 mA
FX5-20PG-D*1	Pulse output for 2-axis control (differential driver output)	8 points	—	—	165 mA
FX5-40SSC-S	Simple motion 4-axis control (SSCNET III/H compatible)	8 points	—	—	250 mA
FX5-80SSC-S	Simple motion 8-axis control (SSCNET III/H compatible)	8 points	—	—	250 mA
FX5-ENET*2	Ethernet communication	8 points	—	110 mA	—
FX5-ENET/IP*2	EtherNet/IP communication, Ethernet communication	8 points	—	110 mA	—
FX5-CCL-MS*1	CC-Link system master/intelligent device station	8 points*3	—	—	100 mA
FX5-CCLIEF*4	CC-Link IE field network intelligent device station	8 points	10 mA	—	230 mA
FX5-ASL-M*1	AnyWireASLINK system master	8 points	200 mA	—	100 mA*5
FX5-DP-M*2	PROFIBUS-DP master	8 points	—	150 mA	—

*1: Supported by FX5U/FX5UC CPU modules Ver. 1.050 or later.

*2: Supported by FX5U/FX5UC CPU modules Ver. 1.110 or later.

*3: When using FX5-CCL-MS as a master station, the number of remote I/O points on the network increases.

*4: Supported by FX5U/FX5UC CPU modules Ver. 1.030 or later.

*5: This value does not include the supply current to slave modules (Max. 2 A).

6 Connector conversion module

Model	Function	Number of occupied input/output points	Current consumption	
			5 V DC power supply	24 V DC power supply
FX5-CNV-IF	Connector conversion (FX5 (Extension cable type) →FX5 (Extension connector type))	—	—	—

7 I/O module (Extension connector type)

Model	I/O type	Number of occupied input/output points	Current consumption	
			5 V DC power supply	24 V DC power supply
FX5-C16EX/D	DC input (sink)	16 points	100 mA	65 mA (0 mA*)
FX5-C16EX/DS	DC input (sink/source)			
FX5-C32EX/D	DC input (sink)	32 points	120 mA	130 mA (0 mA*)
FX5-C32EX/DS	DC input (sink/source)			
FX5-C32EX/DS-TS				
FX5-C16EYT/D	Transistor output (sink)	16 points	100 mA	100 mA
FX5-C16EYT/DSS	Transistor output (source)			
FX5-C16EYR/D-TS	Relay output			
FX5-C32EYT/D	Transistor output (sink)	32 points	120 mA	200 mA
FX5-C32EYT/DSS	Transistor output (source)			
FX5-C32EYT/D-TS	Transistor output (sink)			
FX5-C32EYT/DSS-TS	Transistor output (source)			
FX5-C32ET/D	DC input (sink)/transistor output (sink)			
FX5-C32ET/DSS	DC input (sink/source)/transistor output (source)	Input: 16 points Output: 16 points	120 mA	165 mA (100 mA*)
FX5-C32ET/DS-TS	DC input (sink/source)/transistor output (sink)			
FX5-C32ET/DSS-TS	DC input (sink/source)/transistor output (source)			

*: Current consumption when an external power supply is used for the input circuit.

8 Bus conversion module

Model	Function	Number of occupied input/output points	Current consumption	
			5 V DC power supply	24 V DC power supply
FX5-CNV-BUSC	Bus conversion FX5 (extension cable type) →FX3 extension	8 points	150 mA	—
FX5-CNV-BUS	Bus conversion FX5 (extension cable type) →FX3 extension			

9 FX5 expansion board

Model	Function	Number of occupied input/output points	Current consumption	
			5 V DC power supply	24 V DC power supply
FX5-232-BD	RS-232C communication	—	20 mA	—
FX5-485-BD	RS-485 communication			
FX5-422-BD-GOT	RS-422 communication (for GOT connection)		20 mA*	

*: The current consumption will increase when the 5 V type GOT is connected.

10 FX5 expansion adapter

Model	Function	Number of occupied input/output points	Current consumption			
			5 V DC power supply	24 V DC power supply	24 V DC external power supply	
FX5-232ADP	RS-232C communication	—	30 mA	30 mA	—	
FX5-485ADP	RS-485 communication		20 mA			
FX5-4AD-ADP	4 ch voltage input/current input		10 mA	20 mA		160 mA
FX5-4AD-PT-ADP*	4 ch temperature sensor (resistance temperature detector) input					
FX5-4AD-TC-ADP*	4 ch temperature sensor (thermocouple) input					
FX5-4DA-ADP	4 ch voltage output/current output			—		

*: Supported by FX5U/FX5UC CPU modules Ver. 1.040 or later.

11 FX3 extension power supply module

Model	Function	Number of occupied input/output points	Current consumption	
			5 V DC power supply	24 V DC power supply
FX3U-1PSU-5V	Extension power supply	—	1000 mA*	300 mA*

*: Derating occurs when the ambient temperature exceeds 40°C. For details, refer to manuals of each product.

12 FX3 intelligent function module

Model	Function	Number of occupied input/output points	Current consumption		
			5 V DC power supply	24 V DC power supply	24 V DC external power supply
FX3U-4AD	4 ch voltage input/current input	8 points	110 mA	—	90 mA
FX3U-4DA	4 ch voltage output/current output		120 mA		160 mA
FX3U-4LC	4-loop temperature control (resistance thermometer/thermocouple/micro voltage)		160 mA		50 mA
FX3U-1PG	Pulse output for 1-axis control		150 mA		40 mA
FX3U-2HC	2 ch high-speed counter		245 mA		—
FX3U-16CCL-M	CC-Link master		8 points* ¹		—
FX3U-64CCL	CC-Link intelligent device station	8 points	—	220 mA	
FX3U-128ASL-M	AnyWireASLINK system master	8 points* ²	130 mA	—	100 mA* ³
FX3U-32DP	PROFIBUS-DP slave station	8 points	—	145 mA	—

*1: When using FX3U-16CCL-M as a master station, the number of remote I/O points on the network increases.

*2: The number of input/output points set by the rotary switch is added.

*3: This value does not include the supply current to slave modules (Max. 2 A).

Calculation of current consumed by extension modules (For the AC power supply type)*1

The power required for the expansion adapter, expansion board and extension module is supplied from the CPU module or extension power supply module. Use the following calculations to confirm whether the required power can be supplied. (All calculations must be satisfied.)

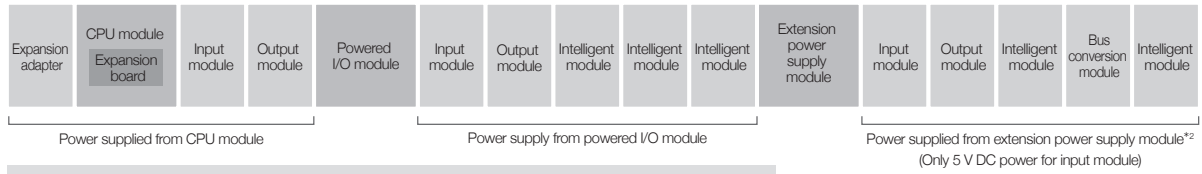

■ Power supply from CPU module

[5 V DC power supply]

5 V DC power supply capacity (CPU module)	-	Total current consumption (Total no. of extension devices to be connected)	=	Calculation results	≥	0 mA
---	---	--	---	---------------------	---	------

[24 V DC power supply]

24 V DC service power supply capacity (CPU module)	-	Total current consumption (Total no. of extension devices to be connected)	=	Calculation results	≥	0 mA*3
--	---	--	---	---------------------	---	--------

■ Power supply from powered I/O module

[5 V DC power supply]

5 V DC power supply capacity (Powered I/O module)	-	Total current consumption (Total no. of extension devices to be connected)	=	Calculation results	≥	0 mA
---	---	--	---	---------------------	---	------

[24 V DC power supply]

24 V DC service power supply capacity (Powered I/O module)	-	Total current consumption (Total no. of extension devices to be connected)	=	Calculation results	≥	0 mA*3
--	---	--	---	---------------------	---	--------

■ Power supply from extension power supply module (When using FX3 extension power supply module, another calculation is required. Refer to manuals for more details.)

[5 V DC power supply]

5 V DC power supply capacity (Extension power supply module)	-	Total current consumption (Total no. of extension devices to be connected)	=	Calculation results	≥	0 mA
--	---	--	---	---------------------	---	------

[24 V DC power supply]

24 V DC power supply capacity (Extension power supply module)	-	Total current consumption (Total no. of extension devices to be connected)	=	Calculation results	≥	0 mA
---	---	--	---	---------------------	---	------

<Cautions>

If the calculation results are negative, the power capacity is exceeded so review the system configuration.

*1: For calculation for the DC power supply type, refer to the manual.
 *2: When connecting an input module to the back stage (right side) of the extension power supply module, power will be supplied from the CPU module or a powered I/O module.
 5 V DC power is supplied from an extension power supply module.
 *3: The 24 V DC service power calculation results value (when positive) indicates the 24 V DC service power supply's remaining capacity, and can be used as an external load power.

Refer to the next section for the details of some products since the number of connected modules may be limited.

Rules for System Configuration

The total number of I/O points and remote I/O points for the CPU module and extension devices controllable in FX5U CPU module is 512 points or less.

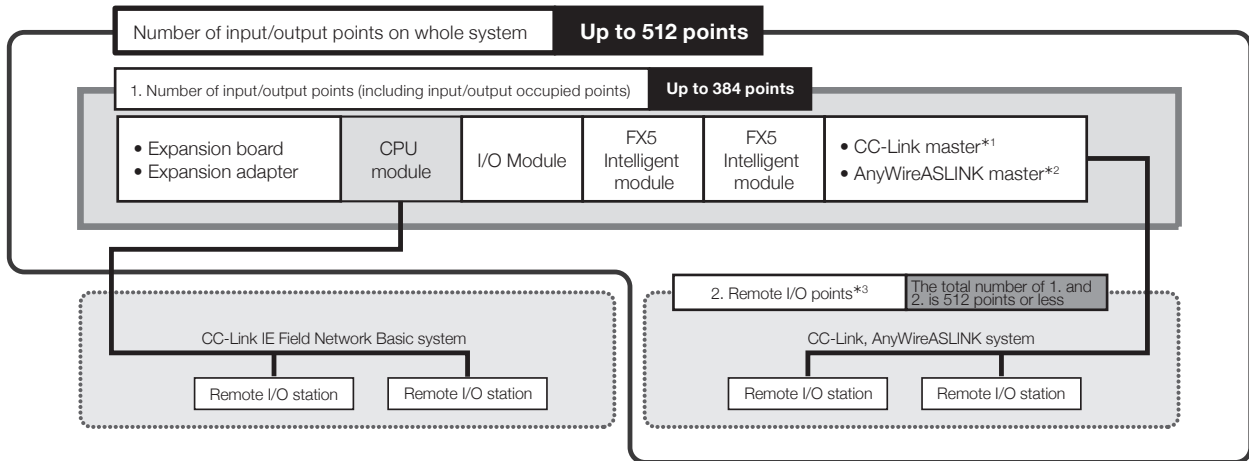

Number of input/output points

The maximum number of I/O points that can be configured with FX5U is as follows.

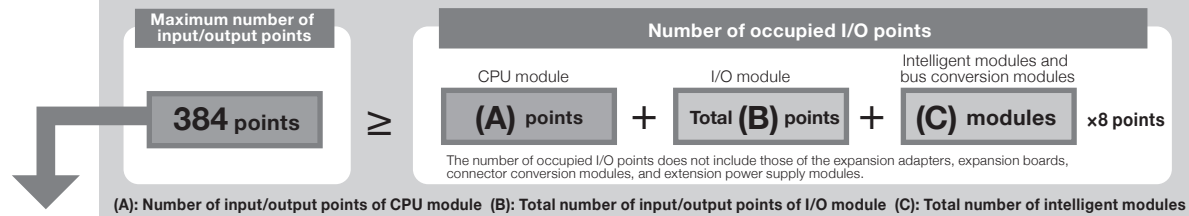

About remote I/O points

The maximum number of I/O points when using a network master module is as follows.

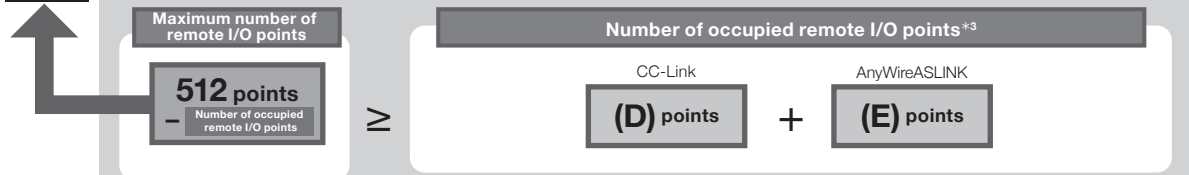

(D) Number of CC-Link remote I/O points

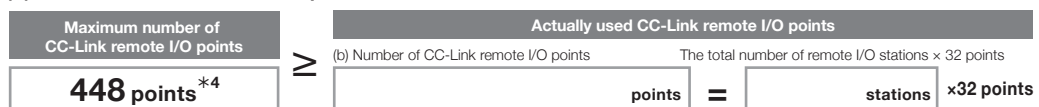

(E) Number of AnyWireASLINK remote I/O points

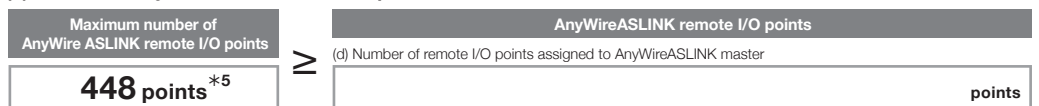

*1: A bus conversion module is required when using the FX3U-16CCL-M.
 *2: A bus conversion module is required when using the FX3U-128ASL-M.
 *3: CC-Link IE Field Network Basic remote I/O stations are not calculated as remote I/O points.
 *4: 256 points when FX3U-16CCL-M is used
 *5: 128 points when FX3U-128ASL-M is used

The number of points will vary if the CPU module firmware version is below 1.110. For details, refer to manuals of each product.

Lineup details/model selection

Limitation on power supply type when connecting

It is not possible to install both the AC type and the DC type in one system.

The power supply type is limited for extension modules connectable to the following CPU modules. For details, refer to the manual of each product.

Type/model/power supply type	Connectable extension module	
	Type	Model/power supply type
FX5U CPU module FX5U-□M□/E□ (AC power supply type)	Powered I/O module	FX5-32E□/E□ (AC power supply type)
	Extension power supply module	FX5-1PSU-5V (AC power supply type)
FX5U CPU module FX5U-□M□/D□ (DC power supply type)	Powered I/O module	FX5-32E□/D□ (DC power supply type)
	Extension power supply module	FX5-C1PS-5V (DC power supply type)

Limitation on number of modules when extending

The number of connectable modules is limited for the following products. For details, refer to manuals of each product.

Type	Model/type	Setting method/precautions
I/O module (Extension cable type)	FX5-16ET/ES-H	Up to 4 modules can be connected for the entire system.
	FX5-16ET/ESS-H	
FX5 intelligent function module	FX5-CCL-MS	One module can be connected in the entire system for each station type. <ul style="list-style-type: none"> • Master station: 1 module*¹ • Intelligent device station: 1 module*²
	FX5-ENET	Only 1 module can be connected in the entire system.
	FX5-ENET/IP	
	FX5-CCLIEF	
	FX5-DP-M	
FX5-ASL-M	Only 1 module can be connected in the entire system. Use together with the FX3U-128ASL-M is not possible.	
FX3 intelligent function module	FX3U-4AD	<ul style="list-style-type: none"> ■ When using FX3U-1PSU-5V: Up to 8 modules can be connected per system. ■ When not using FX3U-1PSU-5V: Up to 6 modules can be connected per system.
	FX3U-4DA	
	FX3U-1PG	
	FX3U-4LC	Only 1 module can be connected in the entire system. It cannot be used together with the FX5-ASL-M. Only 1 module can be connected in the entire system. When using the FX5-CCL-MS as the master station, it cannot be used together with the FX5-CCL-MS. Only 1 module can be connected in the entire system. When using the FX5-CCL-MS as the intelligent device station, it cannot be used together with the FX5-CCL-MS.
	FX3U-128ASL-M	
	FX3U-16CCL-M	
	FX3U-64CCL	
FX3U-2HC	Up to 2 modules can be connected for the entire system. When not using the FX3U-1PSU-5V, connect immediately after the bus conversion module.	

*1: When using the FX5-CCL-MS as the master station, it cannot be used together with the FX3U-16CCL-M.

*2: When using the FX5-CCL-MS as the intelligent device station, it cannot be used together with the FX3U-64CCL.

Selecting the FX5UC model

◇ Product configuration



FX5UC

- Control scale: 32 to 384 points (CPU module: 32/64/96 points)
- Control points up to 512 input/output points, including remote input/output*

*: For CC-Link and AnyWireASLINK



* For details about the connection positions, refer to the manual.

Type	Details	Connection details, model selection
1 CPU module	PLC with built-in CPU, power supply, input/output and program memory.	Various extension devices can be connected.
2 I/O module (extension connector type)	Product for extension I/O of extension connector type.	Input/output can be extended to up to 256 points/384 points* ¹ . Up to 16 extension modules can be connected. (Extension power supply modules and connector conversion modules are not included in the number of connected modules.) For details, refer to "Rules for System Configuration" on p. 55.
3 FX5 extension power supply module	Module for extension power supply if CPU module's internal power supply is insufficient. Connector conversion function is also provided.	Power can be supplied to I/O module, intelligent function module, and bus conversion module. Up to 2 modules can be connected.
4 Connector conversion module	Module for connecting FX5 (extension cable type) extension module	Extension devices (extension cable type) for FX5 can be connected.
5 I/O module (extension cable type)	Product for extending I/O of extension cable type.	Input/output can be extended to up to 256 points/384 points* ¹ . Up to 16 extension modules can be connected. (Connector conversion modules are not included in the number of connected modules.) Up to 4 high-speed pulse I/O modules can be connected. Using this type of I/O module requires the connector conversion module.
6 FX5 intelligent function module	Module with functions other than input/output.	Up to 16 extension modules including I/O modules can be connected. (Connector conversion modules are not included in the number of connected modules.) Using this type of module requires the connector conversion module.
7 Bus conversion module	Conversion module for connecting FX3 extension module.	FX3 Series extension modules can be connected only to the right side of the bus conversion module. Using the FX5-CNV-BUS requires the connector conversion module or extension power supply module.
8 FX5 expansion adapter	Adapter connected to left side of CPU module to expand functions.	Up to 6 modules can be connected to the left side of the CPU module.
9 FX3 intelligent function module	Module with functions other than input/output.	Up to 6 modules* ² can be connected to the right side of the bus conversion module. The bus conversion module is required for use.

*1: Supported by FX5U/FX5UC Ver. 1.100 or later and by GX Works3 Ver. 1.047Z or later.

*2: Excluding some models

1 CPU module

Model	Function	Number of occupied input/output points	Power supply capacity		I/O type	No. of input points	No. of output points
			5 V DC power supply	24 V DC power supply			
FX5UC-32MT/D	CPU module	32 points	720 mA	500 mA	DC input (sink)/transistor (sink)	16 points	16 points
FX5UC-32MT/DSS					DC input (sink/source)/transistor (source)		
FX5UC-32MT/DS-TS					DC input (sink/source)/transistor (sink)		
FX5UC-32MT/DSS-TS					DC input (sink/source)/transistor (source)		
FX5UC-32MR/DS-TS		DC input (sink/source)/relay output					
FX5UC-64MT/D		64 points			DC input (sink)/transistor (sink)	32 points	32 points
FX5UC-64MT/DSS					DC input (sink/source)/transistor (source)		
FX5UC-96MT/D		96 points			DC input (sink)/transistor (sink)	48 points	48 points
FX5UC-96MT/DSS	DC input (sink/source)/transistor (source)						

Lineup details/model selection

2 I/O module (extension connector type)

Model	I/O type	Number of occupied input/output points	Current consumption		
			5 V DC power supply	24 V DC power supply	24 V DC external power supply (24 V DC power supply for input circuit)
FX5-C16EX/D	DC input (sink)	16 points	100 mA	-	65 mA
FX5-C16EX/DS	DC input (sink/source)				
FX5-C32EX/D	DC input (sink)	32 points	120 mA	-	130 mA
FX5-C32EX/DS	DC input (sink/source)				
FX5-C32EX/DS-TS	DC input (sink/source)				
FX5-C16EYT/D	Transistor output (sink)	16 points	100 mA	100 mA	-
FX5-C16EYT/DSS	Transistor output (source)				
FX5-C16EYR/D-TS	Relay output				
FX5-C32EYT/D	Transistor output (sink)	32 points	120 mA	200 mA	-
FX5-C32EYT/DSS	Transistor output (source)				
FX5-C32EYT/D-TS	Transistor output (sink)				
FX5-C32EYT/DSS-TS	Transistor output (source)				
FX5-C32ET/D	DC input (sink)/transistor output (sink)	Input: 16 points Output: 16 points	120 mA	100 mA	65 mA
FX5-C32ET/DSS	DC input (sink/source)/transistor output (source)				
FX5-C32ET/DS-TS	DC input (sink/source)/transistor output (sink)				
FX5-C32ET/DSS-TS	DC input (sink/source)/transistor output (source)				

3 FX5 extension power supply module

Model	Function	Number of occupied input/output points	Power supply capacity	
			5 V DC power supply	24 V DC power supply
FX5-C1PS-5V	Extension power supply	-	1200 mA*	625 mA*

*: Derating occurs when the ambient temperature exceeds 40°C. For details, refer to the manual.

4 Connector conversion module

Model	Function	Number of occupied input/output points	Current consumption	
			5 V DC internal current consumption	24 V DC internal current consumption
FX5-GNV-IFC	Connector conversion (FX5 (Extension connector type) → FX5 (Extension cable type))	-	-	-

5 -1) I/O module (DC power supply/DC input type) (extension cable type)

Model	Function	Number of occupied input/output points	Power supply capacity		I/O type
			5 V DC power supply	24 V DC power supply	
FX5-32ER/DS	Input/output module	32 points	965 mA	310 mA	DC input (sink/source)/relay output
FX5-32ET/DS					DC input (sink/source)/transistor output (sink)
FX5-32ET/DSS					DC input (sink/source)/transistor output (source)

5 -2) I/O module (extension cable type)

Model	Function	Number of occupied input/output points	Current consumption		
			5 V DC power supply	24 V DC power supply	24 V DC external power supply (24 V DC power supply for input circuit)
FX5-8EX/ES	DC input (sink/source)	8 points	75 mA	—	50 mA
FX5-16EX/ES	DC input (sink/source)	16 points	100 mA	—	85 mA
FX5-8EYR/ES	Relay output	8 points	75 mA	75 mA	—
FX5-8EYT/ES	Transistor output (sink)				
FX5-8EYT/ESS	Transistor output (source)				
FX5-16EYR/ES	Relay output	16 points	100 mA	125 mA	—
FX5-16EYT/ES	Transistor output (sink)				
FX5-16EYT/ESS	Transistor output (source)				
FX5-16ER/ES	DC input (sink/source)/relay output	16 points	100 mA	85 mA	40 mA
FX5-16ET/ES	DC input (sink/source)/transistor output (sink)				
FX5-16ET/ESS	DC input (sink/source)/transistor output (source)				
FX5-16ET/ES-H*	DC input (sink/source)/transistor output (sink)	16 points	100 mA	85 mA	40 mA
FX5-16ET/ESS-H*	DC input (sink/source)/transistor output (source)				

*: Supported by FX5U/FX5UC CPU module Ver. 1.030 or later.

6 FX5 intelligent function module

Model	Function	Number of occupied input/output points	Current consumption		
			5 V DC power supply	24 V DC power supply	24 V DC external power supply
FX5-4AD*1	4-ch voltage/current input	8 points	100 mA	40 mA	—
FX5-4DA*1	4-ch voltage/current output	8 points	100 mA	—	150 mA
FX5-8AD*1	8-ch voltage/current/thermocouple/resistance temperature detector input	8 points	—	40 mA	100 mA
FX5-4LC*1	4-ch temperature control (resistance temperature detector/thermocouple/micro voltage)	8 points	140 mA	—	25 mA
FX5-20PG-P*1	Pulse output for 2-axis control (transistor output)	8 points	—	—	120 mA
FX5-20PG-D*1	Pulse output for 2-axis control (differential driver output)	8 points	—	—	165 mA
FX5-40SSC-S	Simple motion 4-axis control (SSCNET III/H compatible)	8 points	—	—	250 mA
FX5-80SSC-S	Simple motion 8-axis control (SSCNET III/H compatible)	8 points	—	—	250 mA
FX5-ENET*2	Ethernet communication	8 points	—	110 mA	—
FX5-ENET/IP*2	EtherNet/IP communication, Ethernet communication	8 points	—	110 mA	—
FX5-CCL-MS*1	CC-Link system master/intelligent device station	8 points*3	—	—	100 mA
FX5-CCLIEF*4	CC-Link IE field network intelligent device station	8 points	10 mA	—	230 mA
FX5-ASL-M*1	AnyWireASLINK system master	8 points	200 mA	—	100 mA*5
FX5-DP-M*2	PROFIBUS-DP master	8 points	—	150 mA	—

*1: Supported by FX5U/FX5UC CPU module Ver. 1.050 or later.

*2: Supported by FX5U/FX5UC CPU module Ver. 1.110 or later.

*3: When using FX5-CCL-MS as a master station, the number of remote I/O points on the network increases.

*4: Supported by FX5U/FX5UC CPU module Ver. 1.030 or later.

*5: This value does not include the supply current to slave modules (Max. 2 A).

7 Bus conversion module

Model	Function	Number of occupied input/output points	Current consumption	
			5 V DC power supply	24 V DC power supply
FX5-CNV-BUSC	Bus conversion FX5 (extension connector type) → FX3 extension	8 points	150 mA	—
FX5-CNV-BUS	Bus conversion FX5 (extension cable type) → FX3 extension			

8 FX5 expansion adapter

Model	Function	Number of occupied input/output points	Current consumption		
			5 V DC power supply	24 V DC power supply	24 V DC external power supply
FX5-232ADP	RS-232C communication	-	30 mA	30 mA	-
FX5-485ADP	RS-485 communication		20 mA		
FX5-4AD-ADP	4 ch voltage input/current input		10 mA	20 mA	
FX5-4AD-PT-ADP*	4 ch temperature sensor (resistance temperature detector) input				
FX5-4AD-TC-ADP*	4 ch temperature sensor (thermocouple) input				
FX5-4DA-ADP	4 ch voltage output/current output			-	

*: Supported by FX5U/FX5UC CPU module Ver. 1.040 or later.

9 FX3 intelligent function module

Model	Function	Number of occupied input/output points	Current consumption			
			5 V DC power supply	24 V DC power supply	24 V DC external power supply	
FX3U-4AD	4 ch voltage input/current input	8 points	110 mA	-	90 mA	
FX3U-4DA	4 ch voltage output/current output		120 mA		160 mA	
FX3U-4LC	4-loop temperature control (resistance thermometer/thermocouple/micro voltage)		160 mA		50 mA	
FX3U-1PG	Pulse output for 1-axis control		150 mA		40 mA	
FX3U-2HC	2 ch high-speed counter		245 mA		-	-
FX3U-16CCL-M	CC-Link master		8 points*1		-	-
FX3U-64CCL	CC-Link intelligent device station	8 points	-	-	220 mA	
FX3U-128ASL-M	AnyWireASLINK system master	8 points*2	130 mA	-	100 mA*3	
FX3U-32DP	PROFIBUS-DP slave station	8 points	-	145 mA	-	

*1: When using FX3U-16CCL-M as a master station, the number of remote I/O points on the network increases.

*2: The number of input/output points set by the rotary switch is added.

*3: This value does not include the supply current to slave modules.

Calculation of current consumed by extension modules

The power required for the expansion adapter and extension module is supplied from the CPU module. Use the following calculations to confirm whether the required power can be supplied. (All calculations must be satisfied.)

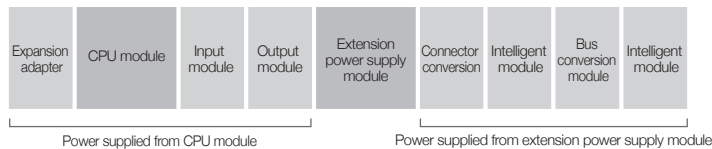

■ Power supply from CPU module

[5 V DC power supply]

$$5 \text{ V DC power supply capacity (CPU module)} - \text{Total current consumption (Total no. of extension devices to be connected)} = \text{Calculation results} \geq 0 \text{ mA}$$

[24 V DC power supply]

$$24 \text{ V DC power supply capacity (CPU module)} - \text{Total current consumption (Total no. of extension devices to be connected)} = \text{Calculation results} \geq 0 \text{ mA}$$

■ Power supply from extension power supply module

[5 V DC power supply]

$$5 \text{ V DC power supply capacity (Extension power supply module)} - \text{Total current consumption (Total no. of extension devices to be connected)} = \text{Calculation results} \geq 0 \text{ mA}$$

[24 V DC power supply]

$$24 \text{ V DC power supply capacity (Extension power supply module)} - \text{Total current consumption (Total no. of extension devices to be connected)} = \text{Calculation results} \geq 0 \text{ mA}$$

<Cautions>

If the calculation results are negative, the power capacity is exceeded so review the system configuration.

Refer to the next section for the details of some products since the number of connected modules may be limited.

Rules for System Configuration

The total number of I/O points and remote I/O points for the CPU module and extension devices controllable in FX5UC CPU module is 512 points or less.

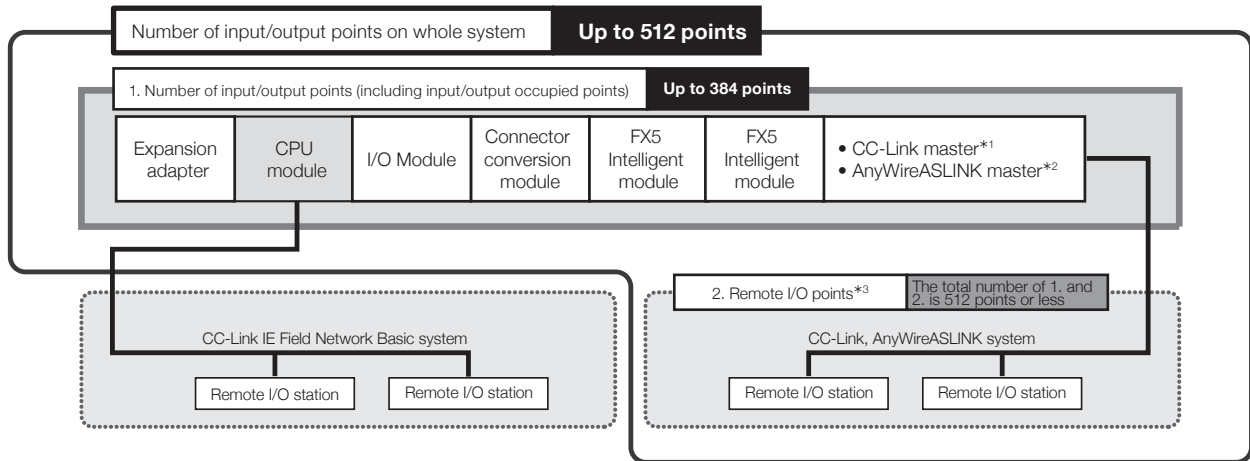

Number of input/output points

The maximum number of I/O points that can be configured with FX5UC is as follows.

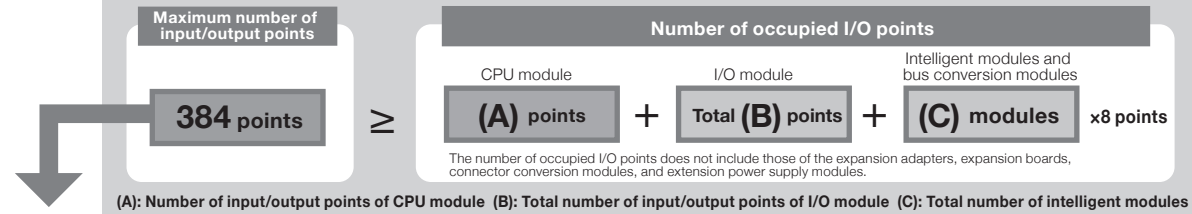

About remote I/O points

The maximum number of I/O points when using a network master module is as follows.

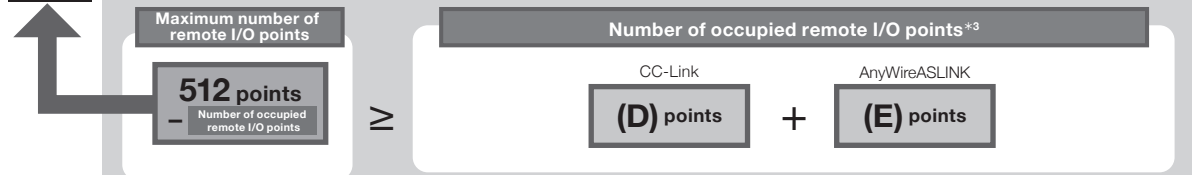

(D) Number of CC-Link remote I/O points

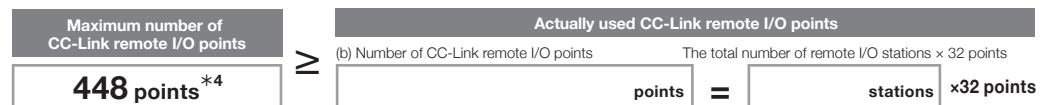

(E) Number of AnyWireASLINK remote I/O points

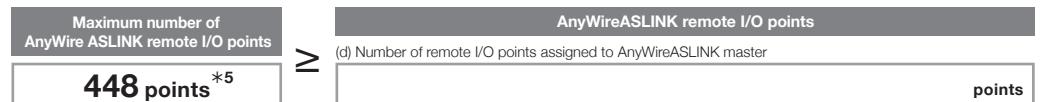

*1: A bus conversion module is required when using the FX3U-16CCL-M.
 *2: A bus conversion module is required when using the FX3U-128ASL-M.
 *3: CC-Link IE Field Network Basic remote I/O stations are not calculated as remote I/O points.
 *4: 256 points when FX3U-16CCL-M is used
 *5: 128 points when FX3U-128ASL-M is used

The number of points will vary if the CPU module firmware version is below 1.110. For details, refer to manuals of each product.

Lineup details/model selection

Limitation on power supply type when connecting

It is not possible to install both the AC type and the DC type in one system.

The power supply type is limited for extension modules connectable to the following CPU modules. For details, refer to the manual of each product.

Type/model/power supply type	Connectable extension module	
	Type	Model/power supply type
FX5UC CPU module FX5UC-□□□/□□ (DC power supply type)	Powered I/O module	FX5-32E□/□□ (DC power supply type)
	Extension power supply module	FX5-C1PS-5V (DC power supply type)

Limitation on number of modules when extending

The number of connectable modules is limited for the following products. For details, refer to manuals of each product.

Type	Model/type	Setting method/precautions
I/O module (Extension cable type)	FX5-16ET/ES-H	Up to 4 modules can be connected for the entire system.
	FX5-16ET/ESS-H	
FX5 intelligent function module	FX5-CCL-MS	One module can be connected in the entire system for each station type. <ul style="list-style-type: none"> • Master station: 1 module*¹ • Intelligent device station: 1 module*²
	FX5-ENET	Only 1 module can be connected in the entire system.
	FX5-ENET/IP	
	FX5-CCLIEF	
	FX5-DP-M	
FX5-ASL-M	Only 1 module can be connected in the entire system. Use together with the FX3U-128ASL-M is not possible.	
FX3 intelligent function module	FX3U-4AD	<ul style="list-style-type: none"> ■ When using FX3U-1PSU-5V: Up to 8 modules can be connected per system. ■ When not using FX3U-1PSU-5V: Up to 6 modules can be connected per system.
	FX3U-4DA	
	FX3U-1PG	
	FX3U-4LC	Only 1 module can be connected in the entire system. It cannot be used together with the FX5-ASL-M. Only 1 module can be connected in the entire system. When using the FX5-CCL-MS as the master station, it cannot be used together with the FX5-CCL-MS. Only 1 module can be connected in the entire system. When using the FX5-CCL-MS as the intelligent device station, it cannot be used together with the FX5-CCL-MS.
	FX3U-128ASL-M	
	FX3U-16CCL-M	
	FX3U-64CCL	
FX3U-2HC	Up to 2 modules can be connected for the entire system. Connect immediately after the bus conversion module.	

*1: When using the FX5-CCL-MS as the master station, it cannot be used together with the FX3U-16CCL-M.

*2: When using the FX5-CCL-MS as the intelligent device station, it cannot be used together with the FX3U-64CCL.

Refer to the manual for details on each model.

I/O Module



The I/O module is a product for extending inputs/outputs. Some products are powered.

Powered input/output modules

Powered input/output module is a powered input/output extension device.

Like with the CPU module, various I/O modules and intelligent function modules can be connected to the rear stage of extension module.

◇ List of powered input/output modules

Model	Total No. of points	No. of input/output points & Input/output type				Compatible CPU module		MASS (Weight): kg	External dimensions W × H × D (mm)	
		Input		Output		FX5U	FX5UC			
AC power supply type 	FX5-32ER/ES	32 points	16 points	24 V DC (sink/source)	16 points	Relay	○	×	Approx. 0.65	150 × 90 × 83
	FX5-32ET/ES					Transistor (sink)				
	FX5-32ET/ESS					Transistor (source)				
DC power supply type 	FX5-32ER/DS	32 points	16 points	24 V DC (sink/source)	16 points	Relay	○	○*	Approx. 0.65	150 × 90 × 83
	FX5-32ET/DS					Transistor (sink)				
	FX5-32ET/DSS					Transistor (source)				

*: Connection with FX5UC requires FX5-CNV-IFC.

◇ Connection cable

The extension cable for connection to the right side of the front-stage device is offered as an accessory of each powered I/O module.

I/O module

Input modules/output modules receive the power from the CPU module, and extend input/output points. Each module can be offered as the extension cable type or extension connector type.

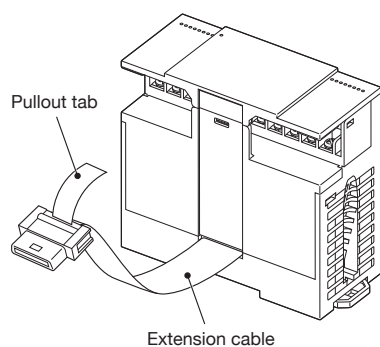

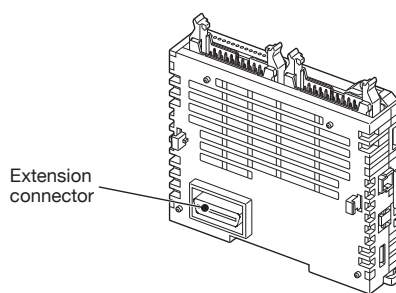

Extension cable type









Extension connector type

◇ List of input modules (extension cable type)

Model		Total No. of points	No. of input/output points & Input/output type				Compatible CPU module		MASS (Weight): kg	External dimensions W x H x D (mm)
			Input		Output		FX5U	FX5UC		
	FX5-8EX/ES	8 points	8 points	24 V DC (sink/source)	—	—	○	○*	Approx. 0.2	40 x 90 x 83
	FX5-16EX/ES	16 points	16 points	24 V DC (sink/source)	—	—			Approx. 0.25	



*: Connection with FX5UC requires FX5-CNV-IFC or FX5-C1PS-5V.

◇ List of output modules (extension cable type)

Model		Total No. of points	No. of input/output points & Input/output type				Compatible CPU module		MASS (Weight): kg	External dimensions W x H x D (mm)
			Input		Output		FX5U	FX5UC		
	FX5-8EYR/ES	8 points	—	—	8 points	Relay	○	○*	Approx. 0.2	40 x 90 x 83
	FX5-8EYT/ES	8 points			8 points	Transistor (sink)			Approx. 0.2	
	FX5-8EYT/ESS	8 points			8 points	Transistor (source)			Approx. 0.2	
	FX5-16EYR/ES	16 points			16 points	Relay			Approx. 0.25	
	FX5-16EYT/ES	16 points			16 points	Transistor (sink)			Approx. 0.25	
	FX5-16EYT/ESS	16 points			16 points	Transistor (source)			Approx. 0.25	

*: Connection with FX5UC requires FX5-CNV-IFC or FX5-C1PS-5V.

◇ List of Input/output modules (extension cable type)

Model		Total No. of points	No. of input/output points & Input/output type				Compatible CPU module		MASS (Weight): kg	External dimensions W x H x D (mm)
			Input		Output		FX5U	FX5UC		
	FX5-16ER/ES	16 points	8 points	24 V DC (sink/source)	8 points	Relay	○	○*	Approx. 0.25	40 x 90 x 83
	FX5-16ET/ES					Transistor (sink)				
	FX5-16ET/ESS					Transistor (source)				

*: Connection with FX5UC requires FX5-CNV-IFC or FX5-C1PS-5V.

◇ List of high-speed pulse input/output modules (extension cable type)

Model		Total No. of points	No. of input/output points & Input/output type				Compatible CPU module		MASS (Weight): kg	External dimensions W × H × D (mm)
			Input		Output		FX5U	FX5UC		
	FX5-16ET/ES-H	16 points	8 points	24 V DC (sink/source)	8 points	Transistor (sink)	○	○*	Approx. 0.25	40 × 90 × 83
	FX5-16ET/ESS-H					Transistor (source)				

*: Connection with FX5UC requires FX5-CNV-IFC or FX5-C1PS-5V.

Connection cable

Extension cable type input/output modules are equipped with the extension cable for connection to the right side of the front-stage device.

◇ List of input modules (extension connector type)

Model		Total No. of points	No. of input/output points & Input/output type				Compatible CPU module		MASS (Weight): kg	External dimensions W × H × D (mm)
			Input		Output		FX5U	FX5UC		
	FX5-C16EX/D	16 points	16 points	24 V DC (sink)	-	-	○*	○	Approx. 0.1	14.6 × 90 × 87
	FX5-C16EX/DS			24 V DC (sink/source)					Approx. 0.1	14.6 × 90 × 87
	FX5-C32EX/D	32 points	32 points	24 V DC (sink)	-	-	○*	○	Approx. 0.15	20.1 × 90 × 87
	FX5-C32EX/DS			24 V DC (sink/source)					Approx. 0.15	20.1 × 90 × 87
	FX5-C32EX/DS-TS			Approx. 0.15					20.1 × 90 × 93.7	

*: Connection with FX5U requires FX5-CNV-IF.

◇ List of output modules (extension connector type)

Model		Total No. of points	No. of input/output points & Input/output type				Compatible CPU module		MASS (Weight): kg	External dimensions W × H × D (mm)
			Input		Output		FX5U	FX5UC		
	FX5-C16EYT/D	16 points	-	-	16 points	Transistor (sink)	○*	○	Approx. 0.1	14.6 × 90 × 87
	FX5-C16EYT/DSS					Transistor (source)			Approx. 0.1	14.6 × 90 × 87
	FX5-C16EYR/D-TS					Relay			Approx. 0.2	30.7 × 90 × 93.7
	FX5-C32EYT/D	32 points	-	-	32 points	Transistor (sink)	○*	○	Approx. 0.15	20.1 × 90 × 87
	FX5-C32EYT/DSS					Transistor (source)			Approx. 0.15	20.1 × 90 × 87
	FX5-C32EYT/D-TS					Transistor (sink)			Approx. 0.15	20.1 × 90 × 93.7
	FX5-C32EYT/DSS-TS					Transistor (source)			Approx. 0.15	20.1 × 90 × 93.7

*: Connection with FX5U requires FX5-CNV-IF.

◇ List of I/O modules (extension connector type)

Model		Total No. of points	No. of input/output points & Input/output type				Compatible CPU module		MASS (Weight): kg	External dimensions W × H × D (mm)
			Input		Output		FX5U	FX5UC		
	FX5-C32ET/D	32 points	16 points	24 V DC (sink)	16 points	Transistor (sink)	○*	○	Approx. 0.15	20.1 × 90 × 87
	FX5-C32ET/DSS			24 V DC (sink/source)		Transistor (source)			Approx. 0.15	20.1 × 90 × 87
	FX5-C32ET/DS-TS			Transistor (sink)		Approx. 0.15			20.1 × 90 × 93.7	
	FX5-C32ET/DSS-TS			Transistor (source)		Approx. 0.15			20.1 × 90 × 93.7	

*: Connection with FX5U requires FX5-CNV-IF.

Examples of combinations of FX5U inputs/outputs

The table below shows examples of combinations of FX5U extension modules. The contents of combinations can be described based on the number of input points.

- In addition to the combinations shown below, various combinations can be made by changing selected I/O modules and extension modules.

Number of I/O points		CPU module		Input/output module		Powered input/output module FX5-32E		Input/output module		I/O total	
Input	Output	Module model	Input	Output	Input	Output	Input	Output	Input		Output
16	16	32M	16	16							32
16	24	32M	16	16	0	8					40
16	32	32M	16	16	0	16					48
16	40	32M	16	16	0	24					56
16	48	32M	16	16	0	32					64
16	64	32M	16	16	0	48					80
24	16	32M	16	16	8	0					40
24	24	32M	16	16	8	8					48
24	32	32M	16	16	8	16					56
24	40	32M	16	16	8	24					64
32	16	32M	16	16	16	0					48
32	32	32M	16	16	16	16					64
32	32	32M	16	16	0	0	16	16			64
32	32	64M	32	32							64
32	40	32M	16	16	0	8	16	16			72
32	40	64M	32	32	0	8					72
32	48	32M	16	16	0	16	16	16			80
32	48	64M	32	32	0	16					80
32	56	32M	16	16	0	24	16	16			88
32	56	64M	32	32	0	24					88
32	64	64M	32	32	0	32					96
32	80	64M	32	32	0	48					112
32	80	64M	32	32	0	48					112
40	16	32M	16	16	24	0					56
40	24	32M	16	16	24	8					64
40	32	32M	16	16	8	0	16	16			72
40	40	32M	16	16	8	8	16	16			80
40	40	80M	40	40							80
40	56	80M	40	40	0	16					96
40	72	80M	40	40	0	32					112
40	88	80M	40	40	0	48					128
48	16	32M	16	16	32	0					64
48	32	32M	16	16	16	0	16	16			80
48	32	64M	32	32	16	0					80
48	48	32M	16	16	16	16	16	16			96
48	48	64M	32	32	16	16					96
48	48	64M	32	32	0	0	16	16			96
48	64	64M	32	32	16	32					112
48	64	64M	32	32	0	16	16	16			112
48	80	64M	32	32	0	32	16	16			128
48	96	64M	32	32	0	48	16	16			144

Number of I/O points		CPU module		Input/output module		Powered input/output module FX5-32E		Input/output module		I/O total	
Input	Output	Module model	Input	Output	Input	Output	Input	Output	Input		Output
56	32	32M	16	16	24	0	16	16			88
56	40	32M	16	16	24	8	16	16			96
56	40	80M	40	40	16	0					96
56	56	80M	40	40	16	16					112
56	56	80M	40	40	0	0	16	16			112
56	72	80M	40	40	16	32					128
56	72	80M	40	40	0	16	16	16			128
56	88	80M	40	40	0	32	16	16			144
56	104	80M	40	40	0	48	16	16			160
64	32	32M	16	16	32	0	16	16			96
64	32	64M	32	32	32	0					96
64	48	32M	16	16	0	0	16	16	32	16	112
64	48	64M	32	32	16	0	16	16			112
64	48	64M	32	32	32	16					112
64	56	32M	16	16	0	8	16	16	32	16	120
64	56	64M	32	32	32	24					120
64	64	32M	16	16	0	16	16	16	32	16	128
64	64	64M	32	32	16	16	16	16			128
64	72	32M	16	16	0	24	16	16	32	16	136
64	80	64M	32	32	16	32	16	16			144
72	40	80M	40	40	32	0					112
72	48	32M	16	16	8	0	16	16	32	16	120
72	56	32M	16	16	8	8	16	16	32	16	128
72	56	80M	40	40	32	16					128
72	56	80M	40	40	16	0	16	16			128
72	64	80M	40	40	32	24					136
72	72	80M	40	40	16	16	16	16			144
72	88	80M	40	40	16	32	16	16			160
80	32	64M	32	32	48	0					112
80	48	32M	16	16	16	0	16	16	32	16	128
80	48	64M	32	32	48	16					128
80	48	64M	32	32	32	0	16	16			128
80	64	32M	16	16	16	16	16	16	32	16	144
80	64	64M	32	32	32	16	16	16			144
80	72	64M	32	32	32	24	16	16			152
80	80	64M	32	32	0	16	16	16	32	16	160
80	96	64M	32	32	0	32	16	16	32	16	176
80	112	64M	32	32	0	48	16	16	32	16	192

Number of I/O points		CPU module		Input/output module		Powered input/output module FX5-32E		Input/output module		I/O total	
Input	Output	Module model	Input	Output	Input	Output	Input	Output			
88	40	80M	40	40	48	0				128	
88	48	32M	16	16	24	0	16	16	32	16	136
88	56	32M	16	16	24	8	16	16	32	16	144
88	56	80M	40	40	48	16					144
88	56	80M	40	40	32	0	16	16			144
88	64	32M	16	16	24	8	16	16	32	24	152
88	72	80M	40	40	32	16	16	16			160
88	80	80M	40	40	32	24	16	16			168
88	88	80M	40	40	0	16	16	16	32	16	176
88	104	80M	40	40	0	32	16	16	32	16	192
88	120	80M	40	40	0	48	16	16	32	16	208
96	32	64M	32	32	64	0					128
96	48	32M	16	16	32	0	16	16	32	16	144
96	48	64M	32	32	48	0	16	16			144
96	56	32M	16	16	32	0	16	16	32	24	152
96	64	64M	32	32	48	16	16	16			160
96	64	64M	32	32	16	0	16	16	32	16	160
96	80	64M	32	32	16	16	16	16	32	16	176
96	96	64M	32	32	16	32	16	16	32	16	192
104	40	80M	40	40	64	0					144
104	56	80M	40	40	48	0	16	16			160
104	72	80M	40	40	48	16	16	16			176
104	72	80M	40	40	16	0	16	16	32	16	176
104	88	80M	40	40	16	16	16	16	32	16	192
104	104	80M	40	40	16	32	16	16	32	16	208
112	48	64M	32	32	64	0	16	16			160
112	64	64M	32	32	32	0	16	16	32	16	176
112	80	64M	32	32	32	16	16	16	32	16	192
112	88	64M	32	32	32	24	16	16	32	16	200
120	56	80M	40	40	64	0	16	16			176
120	72	80M	40	40	32	0	16	16	32	16	192
120	88	80M	40	40	32	16	16	16	32	16	208
120	96	80M	40	40	32	24	16	16	32	16	216
128	64	64M	32	32	48	0	16	16	32	16	192
128	80	64M	32	32	48	16	16	16	32	16	208
128	88	64M	32	32	48	16	16	16	32	24	216
136	72	80M	40	40	48	0	16	16	32	16	208
136	88	80M	40	40	48	16	16	16	32	16	224
136	96	80M	40	40	48	16	16	16	32	24	232

Number of I/O points		CPU module		Input/output module		Powered input/output module FX5-32E		Input/output module		I/O total	
Input	Output	Module model	Input	Output	Input	Output	Input	Output			
144	64	64M	32	32	64	0	16	16	32	16	208
144	72	64M	32	32	64	0	16	16	32	24	216
144	80	64M	32	32	64	0	16	16	32	32	224
152	72	80M	40	40	64	0	16	16	32	16	224
152	80	80M	40	40	64	0	16	16	32	24	232

Examples of combinations of FX5UC inputs/outputs

The table below shows examples of combinations of FX5UC extension modules. The contents of combinations can be described based on the number of input points.

- In addition to the combinations shown below, various combinations can be made by changing selected I/O modules and extension modules.

Number of I/O points		CPU module			Input/output module		Connector conversion module	Input/output module		I/O total
Input	Output	Module model	Input	Output	Input	Output		Input	Output	
16	16	32M	16	16	0	0				32
16	24	32M	16	16	0	0	●		8	40
16	32	32M	16	16	0	16				48
16	48	32M	16	16	0	32				64
24	16	32M	16	16	0	0	●	8		40
24	48	32M	16	16	0	32	●	8		72
24	64	32M	16	16	0	48	●	8		88
24	80	32M	16	16	0	64	●	8		104
32	16	32M	16	16	16	0				48
32	32	32M	16	16	16	16				64
32	32	64M	32	32	0	0				64
32	48	32M	16	16	16	32				80
32	48	64M	32	32	0	16				80
32	64	64M	32	32	0	32				96
32	72	32M	16	16	16	48	●		8	104
32	80	64M	32	32	0	48				112
40	16	32M	16	16	16	0	●	8		56
40	32	32M	16	16	16	16	●	8		72
40	32	64M	32	32	0	0	●	8		72
40	48	32M	16	16	16	32	●	8		88
40	64	64M	32	32	0	32	●	8		104
48	16	32M	16	16	32	0				64
48	32	64M	32	32	16	0				80
48	32	32M	16	16	32	16				80
48	48	32M	16	16	32	32				96
48	48	64M	32	32	16	16				96
48	48	96M	48	48	0	0				96
48	64	96M	48	48	0	16				112
48	64	64M	32	32	16	32				112
48	80	96M	48	48	0	32				128
56	32	32M	16	16	32	16	●	8		88
56	48	32M	16	16	32	32	●	8		104
56	48	64M	32	32	16	16	●	8		104
56	48	96M	48	48	0	0	●	8		104
56	64	32M	16	16	32	48	●	8		120
56	64	64M	32	32	16	32	●	8		120
56	64	96M	48	48	0	16	●	8		120
56	80	64M	32	32	16	48	●	8		136
56	96	96M	48	48	0	48	●	8		152
64	32	32M	16	16	48	16				96
64	48	64M	32	32	32	16				112
64	64	32M	16	16	48	48				128
64	64	96M	48	48	16	16				128
64	80	64M	32	32	32	48				144
64	96	96M	48	48	16	48				160

Number of I/O points		CPU module			Input/output module		Connector conversion module	Input/output module		I/O total
Input	Output	Module model	Input	Output	Input	Output		Input	Output	
72	32	32M	16	16	48	16	●	8		104
72	48	64M	32	32	32	16	●	8		120
72	64	32M	16	16	48	48	●	8		136
72	64	96M	48	48	16	16	●	8		136
72	64	64M	32	32	32	32	●	8		136
72	80	32M	16	16	48	64	●	8		152
72	80	64M	32	32	32	48	●	8		152
72	96	96M	48	48	16	48	●	8		168
80	32	64M	32	32	48	0				112
80	48	64M	32	32	48	16				128
80	48	32M	16	16	64	32				128
80	64	32M	16	16	64	48				144
80	64	96M	48	48	32	16				144
80	80	64M	32	32	48	48				160
80	80	32M	16	16	64	64				160
80	96	64M	32	32	48	64				176
80	96	96M	48	48	32	48				176
88	48	32M	16	16	64	32	●	8		136
88	48	64M	32	32	48	16	●	8		136
88	64	96M	48	48	32	16	●	8		152
88	64	32M	16	16	64	48	●	8		152
88	80	64M	32	32	48	48	●	8		168
88	80	96M	48	48	32	32	●	8		168
88	96	64M	32	32	48	64	●	8		184
88	112	64M	32	32	48	80	●	8		200
88	112	96M	48	48	32	64	●	8		200
88	128	96M	48	48	32	80	●	8		216
96	32	64M	32	32	64	0				128
96	48	96M	48	48	48	0				144
96	48	32M	16	16	80	32				144
96	64	32M	16	16	80	48				160
96	80	64M	32	32	64	48				176
96	96	32M	16	16	80	80				192
96	112	64M	32	32	64	80				208
96	112	96M	48	48	48	64				208
96	128	96M	48	48	48	80				224
96	144	96M	48	48	48	96				240
104	32	32M	16	16	80	16	●	8		136
104	48	96M	48	48	48	0	●	8		152
104	48	32M	16	16	80	32	●	8		152
104	48	64M	32	32	64	16	●	8		152
104	64	32M	16	16	80	48	●	8		168
104	64	64M	32	32	64	32	●	8		168
104	96	64M	32	32	64	64	●	8		200
104	112	96M	48	48	48	64	●	8		216
104	112	64M	32	32	64	80	●	8		216
104	128	96M	48	48	48	80	●	8		232

Number of I/O points		CPU module			Input/output module		Connector conversion module	Input/output module		I/O total
Input	Output	Module model	Input	Output	Input	Output		Input	Output	
112	64	64M	32	32	80	32				176
112	80	96M	48	48	64	32				192
112	96	32M	16	16	96	80				208
112	112	64M	32	32	80	80				224
112	112	96M	48	48	64	64				224
112	128	32M	16	16	96	112				240
112	128	64M	32	32	80	96				240
112	144	96M	48	48	64	96				256
120	64	32M	16	16	96	48	●	8		184
120	80	64M	32	32	80	48	●	8		200
120	96	96M	48	48	64	48	●	8		216
120	112	32M	16	16	96	96	●	8		232
120	112	64M	32	32	80	80	●	8		232
120	128	96M	48	48	64	80	●	8		248
120	128	64M	32	32	80	96	●	8		248
120	136	96M	48	48	64	80	●	8	8	256
128	64	32M	16	16	112	48				192
128	96	96M	48	48	80	48				224
128	96	32M	16	16	112	80				224
128	96	64M	32	32	96	64				224
128	112	96M	48	48	80	64				240
128	112	64M	32	32	96	80				240
128	128	96M	48	48	80	80				256
136	48	32M	16	16	112	32	●	8		184
136	80	64M	32	32	96	48	●	8		216
136	96	96M	48	48	80	48	●	8		232
136	96	64M	32	32	96	64	●	8		232
136	112	64M	32	32	96	80	●	8		248
136	120	96M	48	48	80	64	●	8	8	256
144	64	32M	16	16	128	48				208
144	80	64M	32	32	112	48				224
144	96	96M	48	48	96	48				240
144	112	64M	32	32	112	80				256
144	112	96M	48	48	96	64				256
152	64	32M	16	16	128	48	●	8		216
152	64	64M	32	32	112	32	●	8		216
152	96	96M	48	48	96	48	●	8		248
152	96	64M	32	32	112	64	●	8		248
152	104	96M	48	48	96	48	●	8	8	256
160	64	64M	32	32	128	32				224
160	80	96M	48	48	112	32				240
160	96	64M	32	32	128	64				256
160	96	96M	48	48	112	48				256
168	64	64M	32	32	128	32	●	8		232
168	80	96M	48	48	112	32	●	8		248
168	80	64M	32	32	128	48	●	8		248
168	88	96M	48	48	112	32	●	8	8	256

Number of I/O points		CPU module			Input/output module		Connector conversion module	Input/output module		I/O total
Input	Output	Module model	Input	Output	Input	Output		Input	Output	
176	64	64M	32	32	144	32				240
176	64	96M	48	48	128	16				240
176	80	64M	32	32	144	48				256
184	64	96M	48	48	128	16	●	8		248
184	64	64M	32	32	144	32	●	8		248
184	72	96M	48	48	128	16	●	8	8	256
192	48	64M	32	32	160	16				240
192	56	96M	48	48	144	0	●		8	248
192	64	96M	48	48	144	16				256
200	32	64M	32	32	160	0	●	8		232
200	48	96M	48	48	144	0	●	8		248
200	56	96M	48	48	144	0	●	8	8	256
208	48	96M	48	48	160	0				256

I/O Module

memo

Input/output devices for voltage and current

Analog input/output devices can be used to input and output analog amount of voltage, current, etc.

Analog control essential for FA control can easily be implemented by the PLC.

(For supporting micro voltage input of 0 to 10 mV DC, 0 to 100 mV DC, refer to FX5-4LC for "input device for temperature sensor".)

List of analog input/output devices



◇ Analog input expansion adapter (A/D conversion)

Model (Number of channels)	Input specifications			Isolation	Compatible CPU module		Analog input points
	Item	Input current	Input voltage		FX5U	FX5UC	
 FX5-4AD-ADP (4 ch)	Input range	-20 to +20 mA DC (Input resistance 250 Ω)	-10 to +10 V DC (Input resistance 1 MΩ)	Between input terminal and PLC: Photocoupler isolation Between input channels: Non-isolation	○	○	4 points (4 ch)
	Resolution	1.25 μA (0 to 20 mA) 1.25 μA (4 to 20 mA) 2.5 μA (-20 to +20 mA)	625 μV (0 to 10 V) 312.5 μV (0 to 5 V) 312.5 μV (1 to 5 V) 1250 μV (-10 to +10 V)				

◇ Analog output expansion adapter (D/A conversion)

Model (Number of channels)	Output specifications			Isolation	Compatible CPU module		Analog output points
	Items	Output current	Output voltage		FX5U	FX5UC	
 FX5-4DA-ADP (4 ch)	Output range	0 to 20 mA DC (External load resistance value 0 to 500 Ω)	-10 to +10 V DC (External load resistance value 1 kΩ to 1 MΩ)	Between output terminal and PLC: Photocoupler isolation Between output channels: Non-isolation	○	○	4 points (4 ch)
	Resolution	1.25 μA (0 to 20 mA) 1 μA (4 to 20 mA)	625 μV (0 to 10 V) 312.5 μV (0 to 5 V) 250 μV (1 to 5 V) 1250 μV (-10 to +10 V)				

◇ Analog input module (A/D conversion)

Model (Number of channels)	Input specifications			Isolation	Compatible CPU module		Analog input points
	Items	Input current	Input voltage		FX5U	FX5UC	
 FX5-4AD (4 ch)	Input range	-20 to +20 mA DC (Input resistance 250 Ω)	-10 to +10 V DC (Input resistance 400 kΩ or more)	Between input terminal and PLC: Photocoupler isolation Between input terminal channels: Non-isolation	○	○*2	4 points (4 ch)
	Resolution	625 nA (0 to 20 mA) 500 nA (4 to 20 mA) 625 nA (-20 to +20 mA) 500 nA*1 (User range setting)	312.5 μV (0 to 10 V) 156.25 μV (0 to 5 V) 125 μV (1 to 5 V) 312.5 μV (-10 to +10 V) 125 μV*1 (User range setting)				
 FX5-8AD (8 ch)	Input range	-20 to +20 mA DC (Input resistance 250 Ω)	-10 to +10 V DC (Input resistance 1 MΩ)	Between input terminal and PLC: Photocoupler isolation Between input terminal channels: Non-isolation	○	○*2	8 points (8 ch)
	Resolution	625 nA (0 to 20 mA) 500 nA (4 to 20 mA) 625 nA (-20 to +20 mA)	312.5 μV (0 to 10 V) 156.25 μV (0 to 5 V) 125 μV (1 to 5 V) 312.5 μV (-10 to +10 V)				
 FX3U-4AD (4 ch)	Input range	-20 to +20 mA DC, 4 to 20 mA DC (Input resistance 250 Ω)	-10 to +10 V DC (Input resistance 200 kΩ)	Between input terminal and PLC: Photocoupler isolation Between input channels: Non-isolation	○*3	○*3	4 points (4 ch)
	Resolution	1.25 μA (-20 to +20 mA)	0.32 mV (-10 to +10 V)				



*1: Maximum resolution in the user range setting.

*2: Connection with FX5UC requires FX5-CNV-IFC or FX5-C1PS-5V.

*3: Connection with FX5U or FX5UC requires FX5-CNV-BUS or FX5-CNV-BUSC.

Input/output devices for voltage and current

◇ Analog output module (D/A conversion)

Model (Number of channels)	Output specifications			Isolation	Compatible CPU module		Analog output points
	Items	Output current	Output voltage		FX5U	FX5UC	
FX5-4DA (4 ch) 	Output range	0 to 20 mA DC (External load resistance value 0 to 500 Ω)	-10 to +10 V DC (External load resistance value 1 kΩ to 1 MΩ)	Between output terminal and PLC: Photocoupler isolation Between output channels: Non-isolation	○	○*2	4 points (4 ch)
	Resolution	625 nA (0 to 20 mA) 500 nA (4 to 20 mA) 500 nA*1 (User range setting)	312.5 μV (0 to 10 V) 156.25 μV (0 to 5 V) 125 μV (1 to 5 V) 312.5 μV (-10 to +10 V) 312.5 μV*1 (User range setting)				
FX3U-4DA (4 ch) 	Output range	0 to 20 mA DC, 4 to 20 mA DC (External load resistance value 500 Ω or less)	-10 to +10 V DC (external load resistance value 1 kΩ to 1 MΩ)	Between output terminal and PLC: Photocoupler isolation Between output channels: Non-isolation	○*3	○*3	4 points (4 ch)
	Resolution	0.63 μA (0 to 20 mA)	0.32 mV (-10 to +10 V)				

*1: Maximum resolution in the user range setting.

*2: Connection with FX5UC requires FX5-CNV-IFC or FX5-C1PS-5V.

*3: Connection with FX5U or FX5UC requires FX5-CNV-BUS or FX5-CNV-BUSC.

◇ FX5U CPU module

Built-in analog input

Model (Number of channels)	Input specifications		Isolation
	Items	Input voltage	
FX5U CPU module (2 ch) 	Input range	0 to 10 V DC (Input resistance 115.7 kΩ)	Between analog input circuit and PLC circuit: No isolation Between input channels: No isolation
	Resolution	2.5 mV	

Built-in analog output

Model (Number of channels)	Output specifications		Isolation
	Items	Output voltage	
FX5U CPU module (1 ch) 	Output range	0 to 10 V DC (External load resistance value 2 kΩ to 1 MΩ)	Between analog input circuit and PLC circuit: No isolation
	Resolution	2.5 mV	

FX5-4AD-ADP type expansion adapter

◆ Features



- 1) High-precision analog input adapter with resolution of 14 bits binary.
- 2) 4-channel voltage input (-10 to +10 V DC) or current input (-20 to +20 mA DC) is allowed.
- 3) Voltage or current input can be specified for each channel.
- 4) Data can be transferred programless (no dedicated instructions).

◆ Specifications

Items	Specifications			
Analog input points	4 points (4 channels)			
Analog input voltage	-10 to +10 V DC (input resistance 1 MΩ)			
Analog input current	-20 to +20 mA DC (input resistance 250 Ω)			
Digital output value	14-bit binary value			
Input characteristics, resolution*1	Analog input range		Digital output value	
	Voltage	0 to 10 V	0 to 16000	625 μV
		0 to 5 V	0 to 16000	312.5 μV
		1 to 5 V	0 to 12800	312.5 μV
		-10 to +10 V	-8000 to +8000	1250 μV
	Current	0 to 20 mA	0 to 16000	1.25 μA
		4 to 20 mA	0 to 12800	1.25 μA
-20 to +20 mA		-8000 to +8000	2.5 μA	
Accuracy (Accuracy in respect to full-scale digital output value)	Ambient temperature 25±5°C: within ±0.1% (±16 digits) Ambient temperature 0 to 55°C: within ±0.2% (±32 digits) Ambient temperature -20 to 0°C*2: within ±0.3% (±48 digits)			
Absolute maximum input	Voltage: ±15 V, Current: ±30 mA			
Conversion speed	Up to 450 μs (data refreshed every operation cycle)			
Isolation	Between input terminal and PLC: Photocoupler isolation Between input channels: No isolation			
Power supply	24 V DC, 20 mA (internal power supply) 5 V DC, 10 mA (internal power supply)			
Compatible CPU module	FX5U, FX5UC, compatible from initial product			
Number of occupied input/output points	0 points (no points occupied)			
Number of connectable modules	FX5U, FX5UC: Up to 4 modules to the left side of CPU module			
External dimensions W × H × D (mm)	17.6 × 106 × 89.1			
MASS (Weight): kg	Approx. 0.1			

*1: For the input conversion characteristics, refer to manuals of each product.

*2: Products manufactured earlier than June 2016 do not support this specification.

FX5-4DA-ADP type expansion adapter

◆ Features



- 1) High-precision analog output adapter with resolution of 14 bits binary.
- 2) 4-channel voltage output (-10 to +10 V DC) or current output (0 to 20 mA DC) is allowed.
- 3) Voltage or current output can be specified for each channel.
- 4) Data can be transferred programless (no dedicated instructions).

◆ Specifications

Items	Specifications			
Analog output points	4 points (4 channels)			
Digital input	14-bit binary value			
Analog output voltage	-10 to +10 V DC (external load resistance value 1 kΩ to 1 MΩ)			
Analog output current	0 to 20 mA DC (external load resistance value 0 to 500 Ω)			
Output characteristics, resolution*1	Analog output range		Digital value	
	Voltage	0 to 10 V	0 to 16000	625 μV
		0 to 5 V	0 to 16000	312.5 μV
		1 to 5 V	0 to 16000	250 μV
		-10 to +10 V	-8000 to +8000	1250 μV
	Current	0 to 20 mA	0 to 16000	1.25 μA
		4 to 20 mA	0 to 16000	1 μA
Accuracy (Accuracy in respect to full-scale analog output value)	Ambient temperature 25±5°C: within ±0.1% (Voltage ±20 mV, Current ±20 μA) Ambient temperature -20 to 55°C*2: within ±0.2% (Voltage ±40 mV, Current ±40 μA)			
Conversion speed	Up to 950 μs (data refreshed every operation cycle)			
Isolation	Between output terminal and PLC: Photocoupler isolation Between output channels: No isolation			
Power supply	24 V DC +20%, -15% 160 mA (external power supply) 5 V DC, 10 mA (internal power supply)			
Compatible CPU module	FX5U, FX5UC, compatible from initial product			
Number of occupied input/output points	0 points (no points occupied)			
Number of connectable modules	FX5U, FX5UC: Up to 4 modules to the left side of CPU module			
External dimensions W × H × D (mm)	17.6 × 106 × 89.1			
MASS (Weight): kg	Approx. 0.1			

*1: For details on the output conversion characteristic, refer to manuals of each product.

*2: The ambient temperature specification is 0 to 55°C for products manufactured earlier than June 2016.

FX5-4AD type analog input module

◆ Features



- 1) High-precision analog input module with 312.5 μV at voltage input and 625 nA at current input.
- 2) Spring clamp terminal block type with excellent vibration resistance.
- 3) Data of 10,000 points can be logged for each channel and saved in buffer memory. Leaving logs will be useful for analyzing the cause of trouble.

◆ Specifications

Items	Specifications			
Analog input points	4 points (4 channels)			
Analog input voltage	-10 to +10 V DC (Input resistance 400 k Ω or more)			
Analog input current	-20 to +20 mA DC (Input resistance 250 Ω)			
Absolute maximum input	Voltage: ± 15 V, Current: ± 30 mA			
Digital output value	16-bit signed binary (-32768 to +32767)			
Input characteristics, resolution	Voltage	Analog input range	Digital output value	Resolution
		0 to 10 V	0 to 32000	312.5 μV
	0 to 5 V	0 to 32000	156.25 μV	
	1 to 5 V	0 to 32000	125 μV	
	-10 to +10 V	-32000 to +32000	312.5 μV	
	User range setting	-32000 to +32000	125 μV^*	
	Current	0 to 20 mA	0 to 32000	625 nA
		4 to 20 mA	0 to 32000	500 nA
		-20 to +20 mA	-32000 to +32000	625 nA
User range setting		-32000 to +32000	500 nA [*]	
Accuracy (full scale digital output value accuracy)	Ambient temperature 25 $\pm 5^\circ\text{C}$: within $\pm 0.1\%$ (± 64 digits) Ambient temperature 0 to 55 $^\circ\text{C}$: within $\pm 0.2\%$ (± 128 digits) Ambient temperature -20 to 0 $^\circ\text{C}$: within $\pm 0.3\%$ (± 192 digits)			
Conversion speed	80 $\mu\text{s}/\text{ch}$			
Isolation	Between input terminal and PLC: Photocoupler isolation Between input terminal channels: Non-isolation			
Power supply	5 V DC, 100 mA (internal power supply) 24 V DC, 40 mA (internal power supply)			
Compatible CPU module	FX5U, FX5UC: Ver. 1.050 or later Connection with FX5UC requires FX5-CNV-IFC or FX5-C1PS-5V.			
Number of occupied I/O points	8 points (Either input or output is available for counting.)			
Number of connectable modules	FX5U: Up to 16 modules FX5UC: Up to 16 modules, or up to 15 modules when using a powered I/O module			
External dimensions W x H x D (mm)	40 x 90 x 102.2			
MASS (Weight): kg	Approx. 0.2			

*: Maximum resolution in the user range setting.

FX5-8AD type multiple input module

◆ Features



- 1) High precision multi input module with 312.5 μV at voltage input and 625 nA at current input.
- 2) Spring clamp terminal block type with excellent vibration resistance.
- 3) Data of 10,000 points can be logged for each channel and saved in buffer memory. Leaving logs will be useful for analyzing the cause of trouble.

◆ Specifications

Items	Specifications			
Analog input points	8 points (8 channels)			
Analog input voltage	-10 to 10 V DC (input resistance 1 M Ω)			
Analog input current	-20 to +20 mA DC (input resistance 250 Ω)			
Absolute maximum input	Voltage: ± 15 V, Current: ± 30 mA			
Input characteristics, resolution	Voltage	Analog input range	Digital output value	Resolution
		0 to 10 V	0 to 32000	312.5 μV
	0 to 5 V	0 to 32000	156.25 μV	
	1 to 5 V	0 to 32000	125 μV	
	-10 to +10 V	-32000 to +32000	312.5 μV	
	Current	0 to 20 mA	0 to 32000	625 nA
		4 to 20 mA	0 to 32000	500 nA
		-20 to +20 mA	-32000 to +32000	625 nA
		Digital output value (16-bit signed binary value)	16-bit signed binary (-32000 to +32000)	
Accuracy	Ambient temperature 25 $\pm 5^\circ\text{C}$: within $\pm 0.3\%$ (± 192 digits) Ambient temperature -20 to +55 $^\circ\text{C}$: within $\pm 0.5\%$ (± 320 digits)			
Conversion speed	1 ms/ch			
Isolation	Between input terminal and PLC: Photocoupler isolation Between input terminal channels: Non-isolation			
Power supply	24 V DC, 40 mA (internal power supply) 24 V DC +20%, -15% 100 mA (external power supply)			
Compatible CPU module	FX5U, FX5UC: Ver. 1.050 or later Connection with FX5UC requires FX5-CNV-IFC or FX5-C1PS-5V.			
Number of occupied I/O points	8 points (Either input or output is available for counting.)			
Number of connectable modules	FX5U: Up to 16 modules FX5UC: Up to 16 modules, or up to 15 modules when using a powered I/O module			
External dimensions W x H x D (mm)	50 x 90 x 102.2			
MASS (Weight): kg	Approx. 0.3			

FX3U-4AD type analog input module

◆ Features



- 1) High-precision analog input module with resolution of 15 bits binary + 1-bit sign (voltage) and 14 bits binary + 1-bit sign (current).
- 2) 4-channel voltage input (-10 to +10 V DC) or current input (-20 to +20 mA DC, 4 to 20 mA DC) is allowed.
- 3) Voltage or current input can be specified for each channel.
- 4) High-speed AD conversion of 500 μ s/ch has been implemented.
- 5) Various functions such as digital filter function and peak value hold function have been provided.

◆ Specifications

Items	Input voltage	Input current
Analog input range	-10 to +10 V DC (Input resistance 200 k Ω)	-20 to +20 mA DC, 4 to 20 mA (Input resistance 250 Ω)
Effective digital output	15 bits binary + 1-bit sign	14 bits binary + 1-bit sign
Resolution	0.32 mV (20 V \times 1/64000)	1.25 μ A (40 mA \times 1/32000)
Total precision	[With ambient temperature 25°C \pm 5°C] \pm 0.3% in respect to full-scale 20 V (\pm 60 mV) [With ambient temperature 0 to 55°C] \pm 0.5% in respect to full-scale 20 V (\pm 100 mV)	[With ambient temperature 25°C \pm 5°C] With input of -20 to +20 mA \pm 0.5% (\pm 200 μ A) in respect to full-scale 40 mA Same as with input 4 to 20 mA [With ambient temperature 0 to 55°C] With input of -20 to +20 mA \pm 1% (\pm 400 μ A) in respect to full-scale 40 mA Same as with input 4 to 20 mA
Conversion speed	500 μ s \times Number of channels (5 ms \times Number of channels used when digital filter is used)	
Isolation	Between input terminal and PLC: Photocoupler isolation Between input terminal channels: Non-isolation	
Power supply	5 V DC, 110 mA (internal power supply) 24 V DC \pm 10% 90 mA/24 V DC (external power feed)	
Compatible CPU module	FX5U, FX5UC, compatible from initial product Connection with FX5U requires FX5-CNV-BUS, and connection with FX5UC requires FX5-CNV-BUS or FX5-CNV-BUSC.	
Number of occupied input/output points	8 points (Either input or output is available for counting.)	
Communication with PLC	Carried out by FROM/TO instruction via buffer memory (buffer memory can directly be specified)	
Number of connectable modules	FX5U : Up to 8 modules when FX3U extension power supply modules are used Up to 6 modules when FX3U extension power supply modules are not used FX5UC: Up to 6 modules	
External dimensions W \times H \times D (mm)	55 \times 90 \times 87	
MASS (Weight): kg	Approx. 0.2	

FX5-4DA type analog output module

◆ Features



- 1) High-precision analog output module with 312.5 μ V at voltage output and 625 nA at current output.
- 2) Spring clamp terminal block type with excellent vibration resistance.
- 3) Built-in waveform output function for continuous analog output at a set conversion cycle by registering prepared waveform data (digital value) to the module extension parameter. Faster and smoother output than with programming, and program-free control for reduced overall programming work.

◆ Specifications

Items	Specifications			
Analog output points	4 points (4 channels)			
Analog output voltage	-10 to +10 V DC (external load resistance 1 k Ω to 1 M Ω)			
Analog output current	0 to 20 mA DC (external load resistance 0 to 500 Ω)			
Digital input	16-bit signed binary (-32768 to +32767)			
Output characteristics, resolution	Voltage	Analog output range	Digital value	Resolution
		0 to 10 V	0 to 32000	312.5 μ V
		0 to 5 V	0 to 32000	156.3 μ V
		1 to 5 V	0 to 32000	125 μ V
	-10 to +10 V	-32000 to +32000	312.5 μ V	
	User range setting	-32000 to +32000	312.5 μ V*	
Current	0 to 20 mA	0 to 32000	625 nA	
	4 to 20 mA	0 to 32000	500 nA	
User range setting	-32000 to +32000	500 nA*		
Accuracy (full scale analog output value accuracy)	Ambient temperature 25 \pm 5°C: within \pm 0.1% (Voltage \pm 20 mV, Current \pm 20 μ A) Ambient temperature 0 to 55°C: within \pm 0.2% (Voltage \pm 40 mV, Current \pm 40 μ A) Ambient temperature -20 to 0°C: within \pm 0.3% (Voltage \pm 60 mV, Current \pm 60 μ A)			
Conversion speed	80 μ s/ch			
Isolation	Between output terminal and PLC: Photocoupler isolation Between output channels: Non-isolation			
Power supply	5 V DC, 100 mA (internal power supply) 24 V DC +20%, -15% 150 mA (external power supply)			
Compatible CPU module	FX5U, FX5UC: Ver. 1.050 or later Connection with FX5UC requires FX5-CNV-IFC or FX5-C1PS-5V.			
Number of occupied I/O points	8 points (Either input or output is available for counting.)			
Number of connectable modules	FX5U: Up to 16 modules FX5UC: Up to 16 modules, or up to 15 modules when using a powered I/O module			
External dimensions W \times H \times D (mm)	40 \times 90 \times 102.2			
MASS (Weight): kg	Approx. 0.2			

*: Maximum resolution in the user range setting.

FX3U-4DA type analog output module

◆ Features



- 1) High-precision analog output module with resolution of 15 bits binary + 1-bit sign (voltage) and 15 bits binary (current).
- 2) 4-channel voltage output (-10 to +10 V DC) or current output (0 to 20 mA DC, 4 to 20 mA DC) is allowed.
- 3) Voltage or current output can be specified for each channel.
- 4) Various functions such as table output function and upper-limit/lower-limit value function have been provided.

◆ Specifications

Items	Output voltage	Output current
Analog output range	-10 to +10 V DC (External load 1 kΩ to 1 MΩ)	0 to 20 mA DC, 4 to 20 mA DC (External load 500 Ω or less)
Effective digital input	15 bits binary + 1-bit sign	15-bit binary value
Resolution	0.32 mV (20 V × 1/64000)	0.63 μA (20 mA × 1/32000)
Total precision	Ambient temperature 25±5°C ±0.3% (±60 mV) in respect to full-scale 20 V Ambient temperature 0 to 55°C ±0.5% (±100 mV) in respect to full-scale 20 V	Ambient temperature 25±5°C ±0.3% (±60 μA) in respect to full-scale 20 mA Ambient temperature 0 to 55°C ±0.5% (±100 μA) in respect to full-scale 20 mA
Conversion speed	1 ms (unrelated to the number of channels used)	
Isolation	Between output terminal and PLC: Photocoupler isolation Between output terminal channels: Non-isolation	
Power supply	5 V DC, 120 mA (internal power supply) 24 V DC ±10% 160 mA/24 V DC (external power feed)	
Compatible CPU module	FX5U, FX5UC, compatible from initial product Connection with FX5U requires FX5-CNV-BUS, and connection with FX5UC requires FX5-CNV-BUS or FX5-CNV-BUSC.	
Number of occupied input/output points	8 points (Either input or output is available for counting.)	
Communication with PLC	Carried out by FROM/TO instruction via buffer memory (buffer memory can directly be specified)	
Number of connectable modules	FX5U : Up to 8 modules when FX3U extension power supply modules are used Up to 6 modules when FX3U extension power supply modules are not used FX5UC: Up to 6 modules	
External dimensions W × H × D (mm)	55 × 90 × 87	
MASS (Weight): kg	Approx. 0.2	

Built-in analog input/output function of FX5U CPU module

◆ Features



- 1) FX5U CPU module has built-in analog input/output. It contains 2-channel analog input and 1-channel analog output.

◆ Specifications (built-in analog input/output only)

Items	Specifications	
A/D part	Analog input	0 to 10 V DC (Input resistance 115.7 Ω)
	Absolute maximum input	-0.5 V, +15 V
	Digital output value	0 to 4000
	Digital output	Unsigned 12-bit binary
	Maximum resolution	2.5 mV
	Precision	At ambient temperature of 25°C±5°C, within ±0.5% (±20 digit*) At ambient temperature of 0 to 55°C, within ±1.0% (±40 digit*) At ambient temperature of -20 to 0°C*2, within ±1.5% (±60 digit*)
	Conversion speed	30 μs/channels (data refreshed every operation cycle)

Items	Specifications	
D/A part	Analog output	0 to 10 V DC (External load resistance value 2 kΩ to 1 MΩ)
	Digital input value	0 to 4000
	Digital input	Unsigned 12-bit binary
	Maximum resolution	2.5 mV
	Precision	At ambient temperature of 25°C±5°C, within ±0.5% (±20 digit*) At ambient temperature of 0 to 55°C, within ±1.0% (±40 digit*) At ambient temperature of -20 to 0°C*2, within ±1.5% (±60 digit*)
	Conversion speed	30 μs (data refreshed every operation cycle)

Items	Input specifications	Output specifications	
Common part	Isolation	Inside the PLC: Non-isolation Between input terminal channels: Non-isolation	Inside the PLC: Non-isolation
	Number of occupied input/output points	0 points (no points occupied)	
	External dimensions W × H × D (mm)	FX5U-32M□: 150 × 90 × 83 FX5U-64M□: 220 × 90 × 83 FX5U-80M□: 285 × 90 × 83	
	MASS (Weight): kg	FX5U-32M□: Approx. 0.70 FX5U-64M□: Approx. 1.00 FX5U-80M□: Approx. 1.20	





*1: Digit refers to digital values.

*2: Products manufactured earlier than June 2016 do not support this specification.

Input device for temperature sensor

Platinum resistance thermometer sensor (Pt100) or thermocouple temperature sensors can be connected. FX5-4LC type temperature control module, which provides PID control function with auto tuning, can use a function of intelligent function module to perform temperature control.

◇ List of input devices for temperature sensor

Model (Number of channels)	Compatible sensor	Input specifications		Insulation method	Compatible CPU module		Number of channels					
		Items	Temperature input		FX5U	FX5UC						
FX5-4AD-PT-ADP 	Resistance temperature detector Pt100, Ni100	Input range	Pt100: -200 to 850°C Ni100: -60 to 250°C	Between input terminal and PLC: Photocoupler insulation Between input terminal channels Non-isolation	○	○	4 ch					
		Resolution	0.1°C									
FX5-4AD-TC-ADP 	Thermocouple K, J, T, B, R, S	Input range	[Typical example] K type: -200 to 1200°C J type: -40 to 750°C	Between input terminal and PLC: Photocoupler insulation Between input terminal channels Non-isolation	○	○	4 ch					
		Resolution	0.1°C to 0.3°C (depending on the sensor used)									
FX5-8AD 	Resistance temperature detector Pt100, Ni100	Input range	Pt100: -200 to 850°C Ni100: -60 to 250°C	Between input terminal and PLC: Photocoupler insulation Between input terminal channels: Non-isolation	○	○*	8 ch					
		Resolution	0.1°C									
	Thermocouple K, J, T, B, R, S	Input range	[Typical example] K type: -200 to 1200°C J type: -40 to 750°C									
		Resolution	0.1°C to 0.3°C (depending on the sensor used)									
FX5-4LC 	Resistance temperature detector 3-wire type Pt100 3-wire type JPt100 2-wire/3-wire type Pt1000	Input range	3-wire type Pt100: -200 to 600°C 3-wire type JPt100: -200 to 500°C 2-wire/3-wire type Pt1000: -200 to 650°C	Between analog input part and PLC: Photocoupler insulation Between transistor output part and PLC: Photocoupler insulation Between analog input part and power supply: Insulation by the DC-DC converter Between transistor output part and power supply: Insulation by the DC-DC converter Between channels: Isolated	○	○*	4 ch					
		Resolution	0.1°C or 1°C (depends on the sensor used)									
	Thermocouple K, J, T, B, R, S, N, PLII, W5Re/W26Re, U, L	Input range	[Typical example] K type: -200 to 1300°C J type: -200 to 1200°C									
		Resolution	0.1°C or 1°C (depending on the sensor used)									
	Micro voltage input	Input range	0 to 10 mV DC, 0 to 100 mV DC									
		Resolution	0.5 μV, 5.0 μV									
	FX3U-4LC 	Resistance temperature detector 3-wire type Pt100 3-wire type JPt100 2-wire/3-wire type Pt1000	Input range					[Typical example] Pt100: -200 to 600°C Pt1000: -200.0 to 650.0°C	Between inside and channels: Photocoupler insulation Between inside and power supply: Insulation by the DC-DC converter Between channels: Isolated	○*2	○*2	4 ch
			Resolution					0.1°C or 1°C (depending on the sensor used)				
Thermocouple K, J, R, S, E, T, B, N, PLII, W5Re/W26Re, U, L		Input range	[Typical example] K type: -200.0 to 1300°C J type: -200.0 to 1200°C									
		Resolution	0.1°C or 1°C (depending on the sensor used)									
Micro voltage input		Input range	0 to 10 mV DC, 0 to 100 mV DC									
		Resolution	0.5 μV, 5.0 μV									

*1: Connection with FX5UC requires FX5-CNV-IFC or FX5-C1PS-5V.

*2: Connection with FX5U or FX5UC requires FX5-CNV-BUS or FX5-CNV-BUSC.

FX5-4AD-PT-ADP type resistance temperature detector temperature sensor input expansion adapter

◆ Features

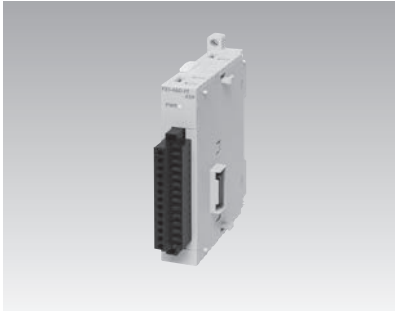

- 1) Resistance temperature detector (Pt100, Ni100) temperature sensor input expansion adapter
- 2) Four channels can be measured with high resolution of 0.1°C.
- 3) It is possible to use a combination of temperature sensors for each channel.
- 4) The measurement unit can be expressed in degrees Celsius (°C) or Fahrenheit (°F).
- 5) Data transfer is possible without programming (no dedicated instructions).

◆ Specifications

Items		Specifications	
Analog input points		4 points (4 channels)	
Usable resistance temperature detector*1		Pt100 Ni100 (DIN 43760 1987)	
Temperature measuring range	Pt100	-200 to 850°C (-328 to 1562°F)	
	Ni100	-60 to 250°C (-76 to 482°F)	
Digital output value		16-bit signed binary value	
Digital output value	Pt100	-2000 to 8500 (-3280 to 1562)	
	Ni100	-600 to 2500 (760 to 4820)	
Accuracy	Ambient temperature 25±5°C	Pt100	±0.8°C
		Ni100	±0.4°C
	Ambient temperature -20 to 55°C	Pt100	±2.4°C
		Ni100	±1.2°C
Resolution		0.1°C (0.1 to 0.2°F)	
Conversion speed*2		Approx 85 ms/channel	
Isolation		Between input terminal and CPU module: Photocoupler isolation Between input terminal channels: Non-isolation	
Power supply		24 V DC, 20 mA (internal power supply) 5 V DC, 10 mA (internal power supply)	
Compatible CPU module		FX5U, FX5UC: Ver. 1.040 or later	
Number of occupied I/O points		0 points (no occupied points)	
Number of connectable modules		FX5U, FX5UC: Up to 4 modules to the left side of CPU module	
External dimensions W × H × D (mm)		17.8 × 106 × 89.1	
MASS (Weight): kg		Approx. 0.1	

*1: Only 3-wire type resistance temperature detectors can be used.
*2: For details of conversion speeds, refer to the manual.

FX5-4AD-TC-ADP type thermocouple temperature sensor input expansion adapter

◆ Features



- 1) Thermocouple temperature sensor input expansion adapter
- 2) Four channels can be measured with high resolution of 0.1°C.
- 3) It is possible to use a combination of temperature sensors for each channel.
- 4) The measurement unit can be expressed in degrees Celsius (°C) or Fahrenheit (°F).
- 5) Data transfer is possible without programming (no dedicated instructions).

◆ Specifications

Item		Specifications		
Analog input points		4 points (4 channels)		
Applicable thermocouple*1		K, J, T, B, R, S		
Temperature measuring range	K	-200 to 1200°C (-328 to 2192°F)		
	J	-40 to 750°C (-40 to 1382°F)		
	T	-200 to 350°C (-328 to 662°F)		
	B	600 to 1700°C (1112 to 3092°F)		
	R	0 to 1600°C (32 to 2912°F)		
	S	0 to 1600°C (32 to 2912°F)		
Digital output value	16-bit signed binary value			
	K	-2000 to 12000 (-3280 to 21920)		
	J	-400 to 7500 (-400 to 13820)		
	T	-2000 to 3500 (-3280 to 6620)		
	B	6000 to 17000 (11120 to 30920)		
	R, S	0 to 16000 (320 to 29120)		
Accuracy*1	Ambient temperature 25±5°C	K	±3.7°C (-100 to 1200°C)*2	±4.9°C (-150 to -100°C)*2
		J	±2.8°C	
		T	±3.1°C (0 to 350°C)*2	±4.1°C (-100 to 0°C)*2
		B	±3.5°C	
		R	±3.7°C	
		S	±3.7°C	
	Ambient temperature -20 to 55°C	K	±6.5°C (-100 to 1200°C)*2	±7.5°C (-150 to -100°C)*2
		J	±4.5°C	
		T	±4.1°C (0 to 350°C)*2	±5.1°C (-100 to 0°C)*2
		B	±6.0°C (-150 to -100°C)*2	
		R	±6.5°C	
		S	±6.5°C	
Resolution	K, J, T	0.1°C (0.1 to 0.2°F)		
	B, R, S	0.1 to 0.3°C (0.1 to 0.6°F)		
Conversion speed*3		Approx. 85 ms/channel		
Isolation		Between input terminal and CPU module: Photocoupler isolation Between input terminal channels: Non-isolation		
Power supply		24 V DC, 20 mA (internal power supply) 5 V DC, 10 mA (internal power supply)		
Compatible CPU module		FX5U, FX5UC: Ver. 1.040 or later		
Number of occupied I/O points		0 point (no occupied points)		
Number of connectable modules		FX5U, FX5UC: Up to 4 modules to the left side of CPU module		
External dimensions W × H × D (mm)		17.8 × 106 × 89.1		
MASS (Weight): kg		Approx. 0.1		

*1: Obtaining sufficient accuracy requires a warm-up of 45 minutes (energization).

*2: Accuracy varies depending on the measured temperature range in ().

*3: For details of conversion speeds, refer to the manual.

FX5-8AD type multiple input module

◆ Features



- 1) Since a single module can handle input of voltage, current, thermocouple, and resistance temperature detector, there is no need to prepare multiple modules for different objects.
- 2) The module can easily detect a disconnection of the thermocouple or resistance temperature detector, and therefore can reduce the downtime and maintenance cost.
- 3) Data of 10000 points can be logged for each channel and saved in buffer memory. Saving logs will be useful for troubleshooting.

◆ Specifications

Item		Specifications	
Analog input points		8 points (8 channels)	
Analog input voltage		-10 to 10 V DC (input resistance 1 MΩ)	
Analog input current		-20 to +20 mA DC (input resistance 250 Ω)	
Absolute maximum input		Voltage: ±15 V, Current: ±30 mA	
Input characteristics, resolution*1	Thermocouple	K, J, T: 0.1°C (0.1 to 0.2°F) B, R, S: 0.1 to 0.3°C (0.1 to 0.6°F)	
	Resistance temperature detector	0.1°C (0.2°F)	
Digital output value (16-bit signed binary value)	Thermocouple	K: -2000 to +12000 (-3280 to +21920) J: -400 to +7500 (-400 to +13820) T: -2000 to +3500 (-3280 to +6620) B: 6000 to 17000 (11120 to 30920) R: 0 to 16000 (320 to 29120) S: 0 to 16000 (320 to 29120)	
	Resistance temperature detector	Pt100: -2000 to +8500 (-3280 to +15620) Ni100: -600 to +2500 (-760 to +4820)	
Accuracy	Thermocouple*2	Ambient temperature 25±5°C	K: ±3.5°C (-200 to -150°C) K: ±2.5°C (-150 to -100°C) K: ±1.5°C (-100 to 1200°C) J: ±1.2°C T: ±3.5°C (-200 to -150°C) T: ±2.5°C (-150 to -100°C) T: ±1.5°C (-100 to 350°C) B: ±2.3°C R: ±2.5°C S: ±2.5°C
		Ambient temperature -20 to 55°C	K: ±8.5°C (-200 to -150°C) K: ±7.5°C (-150 to -100°C) K: ±6.5°C (-100 to 1200°C) J: ±3.5°C T: ±5.2°C (-200 to -150°C) T: ±4.2°C (-150 to -100°C) T: ±3.1°C (-100 to 350°C) B: ±6.5°C R: ±6.5°C S: ±6.5°C
	Resistance temperature detector	Ambient temperature 25±5°C	Pt100: ±0.8°C Ni100: ±0.4°C
		Ambient temperature -20 to 55°C	Pt100: ±2.4°C Ni100: ±1.2°C
Conversion speed	Thermocouple/ Resistance temperature detector	40 ms/ch	
Isolation		Between input terminal and PLC: Photocoupler isolation Between input terminal channels: Non-isolation	
Power supply		24 V DC, 40 mA (internal power supply) 24 V DC +20%, -15% 100 mA (external power supply)	
Compatible CPU module		FX5U, FX5UC: Ver. 1.050 or later Connection with FX5UC requires FX5-CNV-IFC or FX5-C1PS-5V.	
Applicable engineering tool		GX Works3 Ver. 1.035M or later	
Number of occupied I/O points		8 points (can be counted on either input or output)	
Number of connectable modules		FX5U: Up to 16 modules FX5UC: Up to 16 modules, or up to 15 modules when using a powered I/O module	
External dimensions W × H × D (mm)		50 × 90 × 102.2	
MASS (Weight): kg		Approx. 0.3	

*1: For details of input characteristics, refer to the manual.

*2: To stabilize the accuracy, warm-up (supply power) the system for 30 minutes or more after power-on.

FX5-4LC type temperature control module

◆ Features



- 1) Being compatible with the thermocouple, resistance temperature detector, and micro voltage input, the module can be used for a wide range of applications.
- 2) The module can suppress the overshoot in which the output value exceeds the target value or hunting phenomenon which oscillates before and after the target value.
- 3) Since the change in temperature can be checked with the waveform, parameters can be adjusted while checking the waveform displayed in real time.

◆ Specifications

Item		Specifications	
Control system		Two-position control, standard PID control, heating/cooling PID control, cascade control	
Control operation cycle		250 ms/4 ch	
Temperature measuring range		Thermocouple	K: -200 to +1300°C (-100 to +2400°F) J: -200 to +1200°C (-100 to +2100°F) T: -200 to +400°C (-300 to +700°F) S: 0 to 1700°C (0 to 3200°F) R: 0 to 1700°C (0 to 3200°F) E: -200 to +1000°C (0 to 1800°F) B: 0 to 1800°C (0 to 3000°F) N: 0 to 1300°C (0 to 2300°F) PLI: 0 to 1200°C (0 to 2300°F) W5Re/W26Re: 0 to 2300°C (0 to 3000°F) U: -200 to +600°C (-300 to +700°F) L: 0 to 900°C (0 to 1600°F)
		Resistance temperature detector	Pt100 (3-wire type): -200 to +600°C (-300 to +1100°F) JPt100 (3-wire type): -200 to +500°C (-300 to +900°F) Pt1000 (2-wire/3-wire type): -200.0 to +650.0°C (-328 to +1184°F)
		Micro voltage input	0 to 10 mV DC, 0 to 100 mV DC
Heater disconnection detection		Alarm detection	
Input specifications	Number of input points	4 points	
	Input type (selectable for each channel)	Thermocouple	K, J, R, S, E, T, B, N, PLI, W5Re/W26Re, U, L
		Resistance temperature detector	3-wire type Pt100 3-wire type JPt100 2-wire/3-wire type Pt1000
		Micro voltage input	
	Measurement accuracy*	Refer to the MELSEC iQ-F FX5 User's Manual (Temperature Control).	
	Cold junction temperature compensation error	Ambient temperature 0 to 55°C	Within ±1.0°C. When the input value is -150 to -100°C: Within ±2.0°C. When the input value is -200 to -150°C: Within ±3.0°C
		Ambient temperature -20 to 0°C	Within ±1.8°C. When the input value is -150 to -100°C: Within ±3.6°C. When the input value is -200 to -150°C: Within ±5.4°C
	Resolution	0.1°C (0.1°F), 1.0°C (1.0°F), 0.5 μV, or 5.0 μV (depends on the input range of the sensor used)	
	Sampling cycle	250 ms/4 ch	
	Influence of input conductor resistance (for resistance temperature detector input)	3-wire type	Approx. 0.03%/Ω for full scale, and 10 Ω or less per line
		2-wire type	Approx. 0.04%/Ω for full scale, and 7.5 Ω or less per line
	Influence of external resistance (for thermocouple input)	About 0.125 μV/Ω	
Input impedance	1 MΩ or more		
Sensor current	Approx. 0.2 mA (for resistance temperature detector input)		
Operation at input disconnection/short circuit	Upscale/downscale (for resistance temperature detector input)		
Current detector (CT) input specifications	Number of input points	4 points	
	Sampling cycle	0.5 seconds	
Output specifications	Number of points: 4 Type: NPN open collector transistor output, Rated load voltage: 5 to 24 V DC Maximum load current: 100 mA, Control output cycle: 0.5 to 100.0 seconds		
Power supply	5 V DC, 140 mA (internal power supply) 24 V DC +20%, -15% 25 mA (external power supply)		
Isolation	<ul style="list-style-type: none"> • The analog input part and between the transistor output part and PLC are insulated by the photocoupler. • The analog input part and between the transistor output part and power supply are insulated by the DC/DC converter. • Insulated between channels 		
Compatible CPU module	FX5U, FX5UC: Ver. 1.050 or later Connection with FX5UC requires FX5-CNV-IFC or FX5-C1PS-5V.		
Applicable engineering tool	GX Works3 Ver. 1.035M or later		
Number of occupied I/O points	8 points (can be counted on either input or output)		
Number of connectable modules	FX5U: Up to 16 modules FX5UC: Up to 16 modules, or up to 15 modules when using a powered I/O module		
External dimensions W × H × D (mm)	60 × 90 × 102.2		
MASS (Weight): kg	Approx. 0.3		

*: To stabilize the measurement accuracy, warm-up (supply power) the system for 30 minutes or more after power-on.

FX3U-4LC type temperature control module

◆ Features



- 1) The module provides 4-ch temperature sensor input and control output through which "two-position control, standard PID control (auto-tuning possible), heating/cooling PID control, and cascade control" can be carried out. It can also be used in combination with an analog input/output module to perform PID control by voltage and current.
- 2) The module is newly equipped with cascade control. With two control loops of master and slave, the module can quickly adjust the temperature against temperature change due to disturbance or the like.
- 3) Heating/cooling PID control of up to 4 loops can be performed by output operation of 2 systems (heating output and cooling output). Temperature control can be achieved with high stability in both the heating and cooling sides.
- 4) Micro voltage signals such as "0-10 mV DC" and "0-100 mV DC" can be input. Sensors such as micro voltage output sensor can directly be connected.
- 5) The module supports a wide range of thermocouple temperature sensor and high-precision Pt1000 temperature sensor.

◆ Specifications

Items		Specifications
Control system		Two-position control, standard PID control, heating/cooling PID control, and cascade control
Control operation cycle		250 ms/4 ch
Setting temperature range*1		Thermocouple K: -200.0 to 300°C (-100 to 400°F) J: -200.0 to 200°C (-100 to 100°F)
		Resistance temperature detector Pt100 (3-wire type): -200.0 to 00.0°C (-300.0 to 100°F) Pt1000 (2-wire/3-wire type): -200.0 to 50.0°C (-328 to 184°F)
		Micro voltage input 0 to 10 mV DC, 0 to 100 mV DC
Heater disconnection detection		Detection of alarm by buffer memory (variable in the range from 0.0 to 100.0 A)
Input specifications	No. of input points	4 points
	Type of input (selectable for each channel)	[Resistance temperature detector] 3-wire type Pt100 3-wire type JPt100 2-wire/3-wire type Pt1000 [Thermocouple] K, J, R, S, E, T, B, N, PLII, W5Re/W26Re, U, L [Micro voltage input] 0 to 10 mV DC, 0 to 100 mV DC
	Example of measurement accuracy*1*2	[At ambient temperature 25°C±5°C] K type thermocouple input range is 500°C or more: Displayed value ±0.3% ±1 digit [At ambient temperature 0 to 55°C] K type thermocouple input range is 500°C or more: Displayed value ±0.7% ±1 digit
	Example of resolution*1	0.1°C (0.1°F), 1°C (1°F), 0.5 μV, or 5.0 μV
	Sampling cycle	250 ms/4 ch
	Operation at the time of input disconnection/short-circuit	Up scale/down scale (at the time of resistance thermometer sensor input)
Current detector (CT) input specification		Number of points: 4 Current detector: CTL-12-S36-8, CTL-12-S56-10, CTL-6-P-H (manufactured by U.R.D. Ltd.), sampling cycle: 0.5 sec.
Output specifications		Number of points: 4 Type: NPN open collector transistor, Rated load voltage: 5 to 24 V DC, Maximum load current: 100 mA, Control output cycle: 0.5 to 100.0 sec.
Power supply		5 V DC 160 mA (Internal power supply) 24 V DC +20% -15% 50 mA (external power feed from terminal block)
Isolation		Use of photocoupler for isolation between analog inputs/transistor outputs and PLC Use of DC/DC converter for isolation between analog inputs/transistor outputs and power supply Isolation between channels
Compatible CPU module		FX5U, FX5UC, compatible from initial product Connection with FX5U or FX5UC requires FX5-CNV-BUS or FX5-CNV-BUSC.
Number of occupied input/output points		8 points (Either input or output is available for counting.)
Communication with PLC		Carried out by FROM/TO instruction via buffer memory (buffer memory can directly be specified)
Number of connectable modules		FX5U : Up to 8 modules when FX3U extension power supply modules are used Up to 6 modules when FX3U extension power supply modules are not used FX5UC: Up to 6 modules
External dimensions W × H × D (mm)		90 × 90 × 86
MASS (Weight): kg		Approx. 0.4

*1: Differs depending on the sensor input range.

*2: To stabilize the measurement accuracy, warm-up (supply power) the system for 30 minutes or more after power-on.

High speed counter

Using high-speed counters allow PLC to capture high-speed signals from encoders and sensors. Since the CPU module has built-in high performance high-speed counters, high-speed control is possible with simple programs.

List of high-speed counters

◆ Built-in high-speed counter functions of CPU module

Model	Model	Maximum frequency	Operation mode	High-speed processing instruction
	1 phase, 1 input (S/W)	200 kHz	- Normal mode - Pulse density measurement mode - Rotation speed measurement mode	- 32-bit data comparison set - 32-bit data comparison reset - 32-bit data band comparison - 16-bit data high-speed input/output function start/stop - 32-bit data high-speed input/output function start/stop
	1 phase, 1 input (H/W)	200 kHz		
	1 phase, 2 input	200 kHz		
	2 phase, 2 input [1 edge count]	200 kHz		
	2 phase, 2 input [2 edge count]	100 kHz		
	2 phase, 2 input [4 edge count]	50 kHz		
	Internal clock	1 MHz (fixed)		

*: For details, refer to the programming manual and hardware manual of each product.

◆ High-speed counter of FX5U/FX5UC CPU module

High speed counters use parameters to make input allocation and function settings and use HIOEN instruction to perform operations.

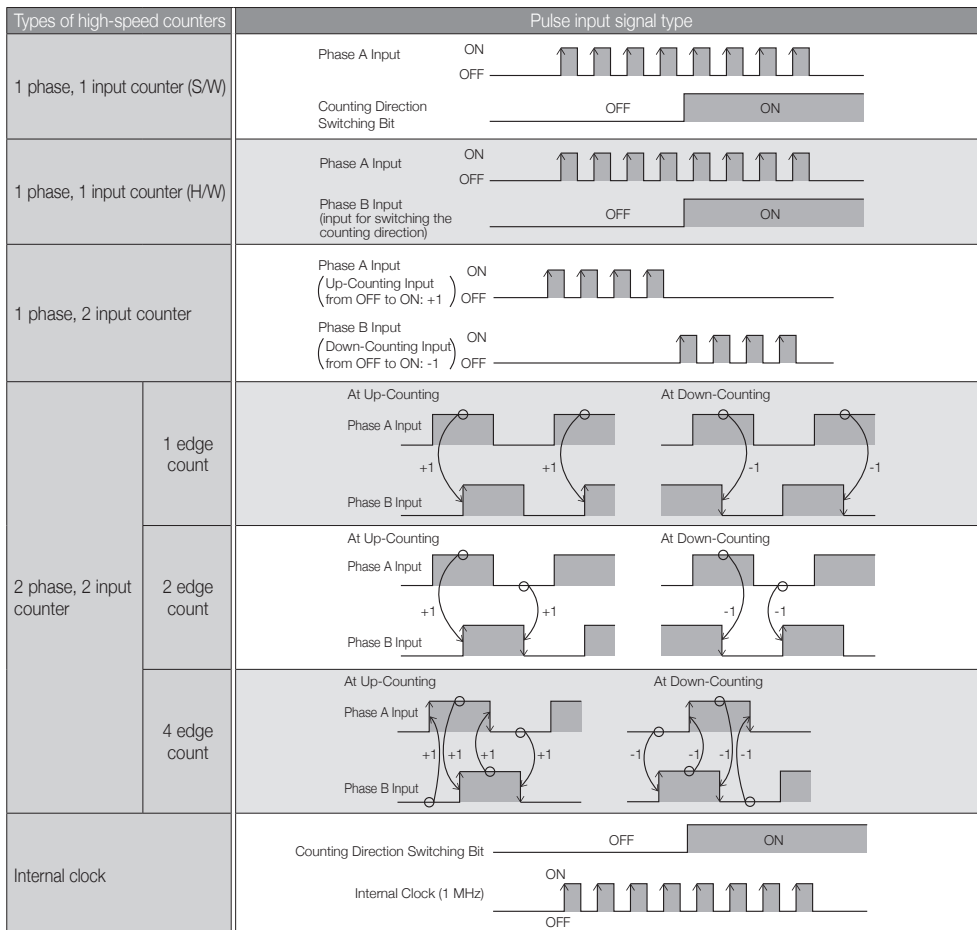

High speed counter

◇ Built-in high-speed counter input allocation

Parameter is used to set the input device allocation of high-speed counters.

Parameter is used to set the function for each channel, and input device allocation is determined by the settings.

When internal clock is used, the allocation is the same as that of 1 phase, 1 input (S/W), without using phase A.

CH	Type of high-speed counter	X0	X1	X2	X3	X4	X5	X6	X7	X10	X11	X12	X13	X14	X15	X16	X17
CH1	1 phase, 1 input (S/W)	A								P	E						
	1 phase, 1 input (H/W)	A	B							P	E						
	1 phase, 2 input	A	B							P	E						
	2 phase, 2 input	A	B							P	E						
CH2	1 phase, 1 input (S/W)		A									P	E				
	1 phase, 1 input (H/W)			A	B							P	E				
	1 phase, 2 input			A	B							P	E				
	2 phase, 2 input			A	B							P	E				
CH3	1 phase, 1 input (S/W)			A										P	E		
	1 phase, 1 input (H/W)					A	B							P	E		
	1 phase, 2 input					A	B							P	E		
	2 phase, 2 input					A	B							P	E		
CH4	1 phase, 1 input (S/W)				A											P	E
	1 phase, 1 input (H/W)							A	B							P	E
	1 phase, 2 input							A	B							P	E
	2 phase, 2 input							A	B							P	E
CH5	1 phase, 1 input (S/W)					A				P	E						
	1 phase, 1 input (H/W)									A	B	P	E				
	1 phase, 2 input									A	B	P	E				
	2 phase, 2 input									A	B	P	E				
CH6	1 phase, 1 input (S/W)						A					P	E				
	1 phase, 1 input (H/W)											A	B	P	E		
	1 phase, 2 input											A	B	P	E		
	2 phase, 2 input											A	B	P	E		
CH7	1 phase, 1 input (S/W)							A						P	E		
	1 phase, 1 input (H/W)													A	B	P	E
	1 phase, 2 input													A	B	P	E
	2 phase, 2 input													A	B	P	E
CH8	1 phase, 1 input (S/W)								A							P	E
	1 phase, 1 input (H/W)															A	B
	1 phase, 2 input															A	B
	2 phase, 2 input															A	B
CH1 to CH8	Internal clock	Not used															

A: Phase A input

B: Phase B input (With 1 phase 1 input (H/W), however, direction switching input is made.)

P: External preset input (Use or nonuse can be selected for each channel using parameters.)

E: External enable input (Use or nonuse can be selected for each channel using parameters.)

◇ High-speed pulse input/output module

Model	Type	Highest frequency	Operation mode	High-speed processing instruction	Compatible CPU module	
					FX5U	FX5UC
 FX5-16ET/ES-H FX5-16ET/ESS-H	1 phase, 1 input (S/W)	200 kHz	- Normal mode	- 16-bit data high-speed input/output function start/stop - 32-bit data high-speed input/output function start/stop	○	○*
	1 phase, 1 input (H/W)	200 kHz				
	1 phase, 2 input	200 kHz				
	2 phase, 2 input [1 edge count]	200 kHz				
	2 phase, 2 input [2 edge count]	100 kHz				
	2 phase, 2 input [4 edge count]	50 kHz				
	Internal clock	1 MHz (fixed)				

*: Connection with FX5UC requires FX5-CNV-IFC or FX5-C1PS-5V.

◇ **Input assignment and the maximum frequency for each input assignment of the high-speed pulse input/output module**

“□” of each input represents the prefix input number of the high-speed pulse input/output module.

“X□+6” and “X□+7” are input frequency up to 10 kHz without regard to the maximum frequency value.

The “preset” input and “enable” input are input frequency up to 10 kHz without regard to the maximum frequency value.

CH	High-speed counter type	X□	X□+1	X□+2	X□+3	X□+4	X□+5	X□+6	X□+7	Maximum frequency
CH9, CH11, CH13, CH15	1 phase, 1 input (S/W)	A	P					E		200 kHz
	1 phase, 1 input (H/W)	A	B	P				E		200 kHz
	1 phase, 2 input	A	B	P				E		200 kHz
	2 phase, 2 input [1 edge count]	A	B	P				E		200 kHz
	2 phase, 2 input [2 edge count]	A	B	P				E		100 kHz
	2 phase, 2 input [4 edge count]	A	B	P				E		50 kHz
CH10, CH12, CH14, CH16	1 phase, 1 input (S/W)				A	P			E	200 kHz
	1 phase, 1 input (H/W)				A	B	P		E	200 kHz
	1 phase, 2 input				A	B	P		E	200 kHz
	2 phase, 2 input [1 edge count]				A	B	P		E	200 kHz
	2 phase, 2 input [2 edge count]				A	B	P		E	100 kHz
	2 phase, 2 input [4 edge count]				A	B	P		E	50 kHz
CH9 to CH16	Internal clock	Not used								

A: Phase A input
 B: Phase B input (For 1-phase 1-input (H/W): direction change input)
 P: External "preset" input (Use or nonuse can be selected for each channel using parameters.)
 E: External "enable" input (Use or nonuse can be selected for each channel using parameters.)

◇ **High-speed counter module**

Model (Number of channels)	Type	Highest response frequency	Function	Hardware comparison output function	2-phase counter edge count function	Compatible CPU module	
						FX5U	FX5UC
 FX3U-2HC (2 ch)	1 phase 1 input	Max. 200 kHz	With match output (delay of up to 30 μs) function Output type: Output common to sink/source 2 points/channel	○	-	○* Up to 2 modules	○* Up to 2 modules
	1 phase 2 input	Max. 200 kHz					
	2 phase 2 input	1 edge count: Max. 200 kHz 2 edge count: Max. 100 kHz 4 edge count: Max. 50 kHz			○		

*: Connection with FX5U or FX5UC requires FX5-CNV-BUS or FX5-CNV-BUSC.

FX3U-2HC type high-speed counter module

◆ Features

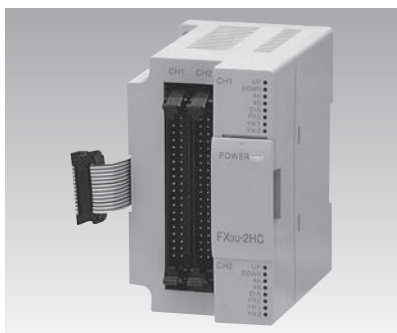

- 1) Input of 2-ch high-speed signal can be made in a module to count a maximum of 200 kHz. Each channel is equipped with 2 high-speed output terminal points based on the setting of comparison value received from CPU module.
- 2) In 2-phase input, 1/2/4 edge count mode can be set.
- 3) Counting can be permitted/inhibited in CPU module or external input.
- 4) Connection with an encoder of line driver output type can be made.
- 5) I/O signal connection adopts a connector system and is compact.

◆ Specifications

Items	Specifications
No. of input points	2 points
Signal level	According to connection terminals, 5 V DC, 12 V DC and 24 V DC are selectable. The line driver output type is connected to the 5 V terminal.
Frequency	1 phase, 1 input: 200 kHz or less 1 phase, 2 input: 200 kHz or less 2 phase, 2 input: 200 kHz or less/1 edge count, 100 kHz or less/2 edge count, 50 kHz or less/4 edge count
Counting range	Binary signed 32 bits (-2,147,483,648 to +2,147,483,647) or binary unsigned 16 bits (0 to 65,535)
Count mode	Automatic up/down (with 1 phase 2 input or 2 phase input, or selected up/down (with 1 phase 1 input)
Match output	When the current value of the counter matches a comparison set value, comparison output is set within 30 μs (ON), and cleared (OFF) within 100 μs by reset instruction.
Output type	2 points/ch, 5 to 24 V DC 0.5 A (output common to sink/source)
Additional function	Buffer memory is available to set mode and comparison data from the CPU module. Current value, comparison results, and error status can be monitored via the CPU module.
Current consumption	5 V DC 245 mA (Internal power supply)
Compatible CPU module	FX5U, FX5UC, compatible with initial product or later Connection with FX5U or FX5UC requires FX5-CNV-BUS or FX5-CNV-BUSC.
Number of occupied input/output points	8 points (Either input or output is available for counting.)
Communication with PLC	Carried out by FROM/TO instruction via buffer memory (buffer memory can directly be specified)
Number of connectable modules	FX5U, FX5UC: Up to 2 modules
External dimensions W × H × D (mm)	55 × 90 × 87
MASS (Weight): kg	Approx. 0.2

◆ Option

Connector for discrete wires (40-pin)

Model name	Type
FX-I/O-CON2-S	Connector for single wires AWG22 (0.3 mm ²)
FX-I/O-CON2-SA	Connector for single wires AWG20 (0.5 mm ²)

External device connection connectors and connection cables etc. are not included with the product. Please arrange them by the customer.

FX5-16ET/E□-H type high-speed pulse input/output module

◆ Features

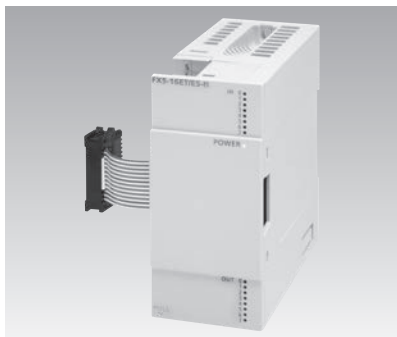

- 1) Input of high-speed pulses can be counted (2 ch, 200 kHz).
- 2) The high-speed counter function and the positioning function can be used together (2 ch + 2 axes). The terminals not assigned can be used as general-purpose input/output.

◆ Specifications

Items	Specifications
High-speed pulse input	2 ch
Input response frequency	X□ to X□+5* X□+6, X□+7*
Power supply	5 V DC, 100 mA (internal power supply) 24 V DC, 125 mA (supplied from service power supply or external power supply)
Compatible CPU module	FX5U, FX5UC from Ver. 1.030 Connection with FX5UC requires FX5-CNV-IFC or FX5-C1PS-5V.
Number of connectable modules	FX5U, FX5UC: Up to 4 modules
External dimensions W × H × D (mm)	40 × 90 × 83
MASS (Weight): kg	Approx. 0.25

*: "□" represents the prefix input number of each high-speed pulse input/output module.

Positioning control

In addition to CPU module built-in positioning instructions, a pulse output module has been prepared to achieve full-scale positioning control. Furthermore, simple motion modules, which can perform complicated control as well as even multi-axis/interpolation control, are lined up to support positioning control.

List of positioning control

◇ Built-in pulse output function of CPU module

Model/feature	Items	Function
FX5U/FX5UC  The module is equipped with positioning function for 4-axis pulse output and 8-ch input.	Number of control axes	4 axes* (Simple linear interpolation by 2-axis simultaneous start)
	Maximum frequency	2147483647 (200 kpps in pulses)
	Positioning program	Sequence program, Table operation
	Compatible CPU module	Transistor output type
	Pulse output instruction	PLSY and DPLSY instructions
	Positioning instruction	DSZR, DDSZR, DVIT, DDVIT, TBL, DRVTBL, DRVMUL, DABS, PLSV, DPLSV, DRVI, DDRVI, DRVA, and DDRVA instructions

*: The number of control axes is 2 when the pulse output mode is CW/CCW mode.



◇ High-speed pulse input/output module

Model/feature	Items	Function	Compatible CPU module	
			FX5U	FX5UC
FX5-16ET/ES-H FX5-16ET/ESS-H  Up to 200 kpps pulse output is possible. Because various positioning operation modes are supported, the module is suitable for 2-axis simple positioning.	Number of control axes	2 axes (Simple linear interpolation by 2-axis simultaneous start)	○	○*
	Maximum frequency	2147483647 (200 kpps in pulses)		
	Positioning program	Sequence program, Table operation		
	Output type	FX5-16ET/ES-H: Transistor output (Sink type) FX5-16ET/ESS-H: Transistor output (Source type)		
	Pulse output instruction	—		
	Positioning instruction	DSZR, DDSZR, DVIT, DDVIT, DRVTBL, DRVMUL, DABS, PLSV, DPLSV, DRVI, DDRVI, DRVA, and DDRVA instructions		

*: Connection with FX5UC requires FX5-CNV-IFC or FX5-C1PS-5V.

Positioning control

◇ Pulse output module

Model/feature	Items	Function		Compatible CPU module	
		FX5-20PG-P	FX5-20PG-D	FX5U	FX5UC
FX5-20PG-P FX5-20PG-D  <p>Two-axis positioning module equipped with linear interpolation and circular interpolation. By analyzing the positioning data in advance, it can start the positioning at high speeds.</p>	Number of control axes	2 axes		○	○*1
	Interpolation	2-axis linear interpolation, 2-axis circular interpolation			
	Output type	Transistor	Differential driver		
	Pulse output type	PULSE/SIGN mode, CW/CCW mode Phase A/B (4 multiplication), phase A/B (1 multiplication)			
	Command speed	200 kpps	5 Mpps		
	Control system	PTP (Point To Point) control, path control (both linear and arc configurable), speed control, speed/position switching control, position/speed switching control			
	Positioning program	Sequence program			
	Positioning data	600 data/axis			
	Number of occupied I/O points	8 points (can be counted on either input or output)			
	FX3U-1PG  <p>Up to 200 kpps pulse output is possible. Because various positioning operation modes are supported the module is suitable for 1-axis simple positioning.</p>	Number of control axes	1 axis		
Interpolation function		—			
Command speed		200 kpps			
Output type		Transistor			
Pulse output type		Forward rotation pulse/reverse rotation pulse, or pulse train + direction			
Manual pulse generator connection		—			
Positioning program		Sequence program (FROM/TO instruction)			
ABS current value read		Allowed by a sequence program			
Number of occupied input/output points		8 points (Either input or output is available for counting.)			

*1 : Connection with FX5UC requires FX5-CNV-IFC or FX5-C1PS-5V.

*2 : Connection with FX5U or FX5UC requires FX5-CNV-BUS or FX5-CNV-BUSC.

◇ Simple motion module

Model/feature	Items	Function		Compatible CPU module	
		FX5-40SSC-S	FX5-80SSC-S	FX5U	FX5UC
FX5-40SSC-S FX5-80SSC-S  <p>Since the module is compatible with SSCNET III/H, high-speed/high-precision positioning can be achieved in combination with MR-J4 servo motor. Parameter settings and table operation settings can easily be made with GX Works3.</p>	Number of control axes	4 axes	8 axes	○	○*1
	Interpolation function	2-axis, 3-axis, 4-axis linear interpolation 2-axis circular interpolation			
	Control system	PTP (Point To Point) control, Trajectory control (both linear and arc), Speed control, Speed-position switching control, Position-speed switching control, Speed-torque control			
	Mark detection function	Regular mode, Specified Number of Detections mode, Ring Buffer mode Mark detection signal: up to 4 points, mark detection setting: 16 settings			
	Digital oscilloscope function*2	Bit data: 16 ch, Word data: 16 ch			
	Servo amplifier connection method	SSCNET III/H			
	Manual pulse generator connection	Possible to connect 1 module			
	Positioning program	Sequence program			
	Number of occupied input/output points	8 points (Either input or output is available for counting.)			

*1: Connection with FX5UC requires FX5-CNV-IFC or FX5-C1PS-5V.

*2: 8 ch word data and 8 ch bit data can be displayed in real time.

◇ **List of positioning operation modes** To confirm detailed operation of each module, refer to manuals of the product.

Positioning instruction Operation pattern	Details	FX5U, FX5UC	FX5-16ET/ES-H, FX5-16ET/ESS-H	FX5-20PG-P, FX5-20PG-D	FX3U-1PG	FX5-40SSC-S, FX5-80SSC-S
<p>◆ JOG operation</p>	While the forward rotation/reverse rotation instruction input is ON, the motor performs forward rotation/reverse rotation.	○ *1	○ *1	○	○	○
<p>◆ Machine home position return</p>	The module starts operation at a home position return speed according to the machine home position return start instruction and then outputs clear signal after the end of machine home position return.	○ *2	○ *2	○ *2*3	○ *2*3	○ *2*4
<p>◆ 1-speed positioning</p>	The module starts operation at an operation speed according to start instruction and then stops at a target position.	○	○	○	○	○
<p>◆ 2-speed operation (2-speed positioning)</p>	The module moves at operation speed (1) for amount of movement (1) and then moves at operation speed (2) for amount of movement (2) according to start instruction.	○ *5	○ *5	○	○	○
<p>◆ Multi-speed operation</p>	Multi-speed operation can be achieved by performing continuous trajectory control of multiple tables. The diagram on left shows continuous trajectory control of 3 tables.	○ *5	○ *5	○	×	○
<p>◆ Interrupt stop</p>	The module starts operation according to start instruction and then stops at the target position. When interrupt input is ON, the module decelerates and stops.	○	○	×	○	×
<p>◆ Interrupt and 1-speed positioning (interrupt and 1-speed pitch feed)</p>	When interrupt input is ON, the module moves at the same speed for the specified amount of movement, and then decelerates and stops.	○	○	○	○	○
<p>◆ Interrupt and 2-speed positioning (interrupt and 2-speed pitch feed)</p>	When interrupt input (1) is ON, the module decelerates to the 2nd speed. When interrupt input (2) is ON again, the module moves only for the specified amount of movement, and then decelerates and stops.	○ *6	○ *6	○ *7	○	○ *7

- *1: Can be substituted by variable speed operation instruction.
- *2: Dog search function available
- *3: Count type, and data set type function available
- *4: Count type, scale origin signal detection type, and data set type function available.
- *5: Can be substituted by 1-speed positioning table operation.
- *6: Can be substituted by variable speed operation or interrupt 1-speed positioning operation.
- *7: Can be substituted by speed-position switching control and speed change function.

Positioning control

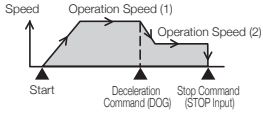
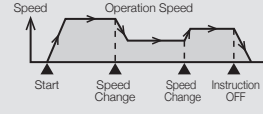
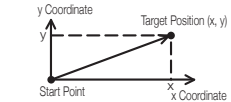
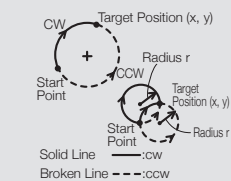
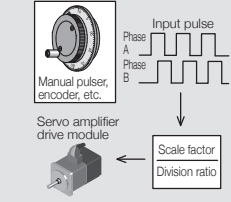
Positioning instruction Operation pattern	Details	FX5U, FX5UC	FX5-16ET/ES-H, FX5-16ET/ESS-H	FX5-20PG-P, FX5-20PG-D	FX3U-1PG	FX5-40SSC-S, FX5-80SSC-S																
<p>◆ Interrupt 2-speed positioning (external instruction positioning)</p> 	<p>The module starts operation at operation speed (1) according to start instruction and then starts decelerating according to deceleration instruction. The module performs operation at operation speed (2) until the input of stop instruction.</p>	○ *6	○ *6	×	○	×																
<p>◆ Variable speed operation</p> 	<p>The module operates at the operation speed specified from PLC.</p>	○	○	○	○	○																
<p>◆ Linear interpolation</p> 	<p>The module moves to the target position at the specified speed. For the speed, composite speed and reference axis speed are selectable.</p>	○ *8	○ *8	○	×	○																
<p>◆ Circular interpolation</p> 	<p>The module moves to the target position (x, y) at the peripheral speed according to circular interpolation instruction. Operation can be performed according to sub point designation or center point designation.</p>	×	×	○	×	○																
<p>◆ Table operation</p> <table border="1" data-bbox="215 1164 486 1310"> <thead> <tr> <th>No.</th> <th>Position</th> <th>Speed</th> <th>.....</th> </tr> </thead> <tbody> <tr> <td>1</td> <td>200</td> <td>500</td> <td></td> </tr> <tr> <td>2</td> <td>500</td> <td>1000</td> <td></td> </tr> <tr> <td>3</td> <td>1000</td> <td>2000</td> <td></td> </tr> </tbody> </table>	No.	Position	Speed	1	200	500		2	500	1000		3	1000	2000		<p>A table is available to create a program for positioning control.</p>	○	○	○	×	○
No.	Position	Speed																			
1	200	500																				
2	500	1000																				
3	1000	2000																				
<p>◆ Pulse generator input operation</p> 	<p>External pulse can be input from the manual pulse generator input terminal. Synchronous ratio operation using an encoder etc., can be performed.</p>	×	×	○	×	○																

*6: Can be substituted by variable speed operation or interrupt 1-speed positioning operation.
*8: Simple linear interpolation only.

Built-in positioning function of FX5U/FX5UC CPU module

◆ Features



- 1) Can position up to 4 axes using transistor outputs (Y0, Y1, Y2 and Y3) of the CPU module.
- 2) Can output pulse trains of 200 kpps maximum.
- 3) Can realize a reasonable system configuration because the intelligent function module for positioning is not required.
- 4) Change of the speed and positioning address can be made during positioning operation.
- 5) Supports the simple linear interpolation operation.

◆ Specifications

Items	Specifications
Number of control axes	4 axes* (Simple linear interpolation possible by 2-axis simultaneous start)
Maximum frequency	2147483647 (200 kpps in pulses)
Positioning program	Sequence program, Table operation
Compatible CPU module	Transistor output type
Pulse output instruction	PLSY and DPLSY instructions
Positioning instruction	DSZR, DDSZR, DVIT, DDVIT, TBL, DRVTBL, DRVMUL, DABS, PLSV, DPLSV, DRVI, DDRVI, DRVA, and DDRVA instructions

*: The number of control axes is 2 when the pulse output mode is CW/CCW mode.

[Example of Packaging System Using built-in positioning]

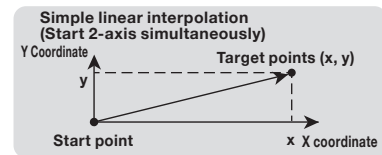
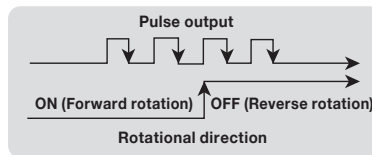
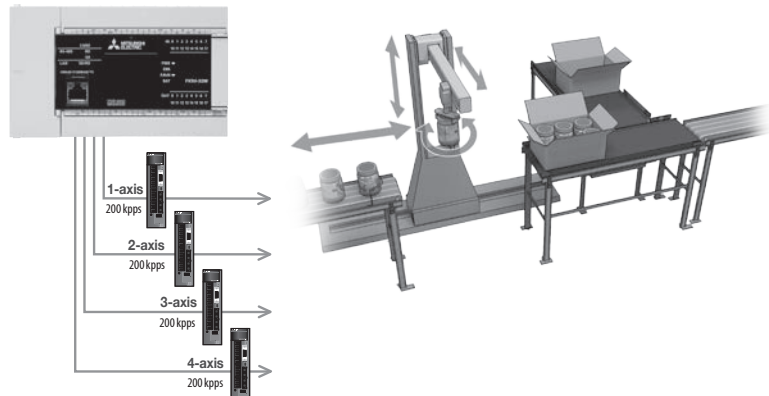

FX5-16ET/E□-H type high-speed pulse input/output module

◆ Features

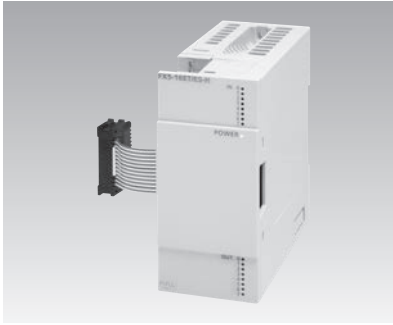

- 1) Can extend the high-speed counter function (2 channels) and positioning function (2 axes) at the same time, and realize a reasonable system configuration.
- 2) Offers easy extension in the same way as the positioning function built in the CPU module.
- 3) Can output pulse trains of 200 kpps maximum.
- 4) Allows terminals not using the high-speed counter function or positioning function to be used for general-purpose inputs/outputs.

◆ Specifications

Items	Specifications
Number of control axes	2 axes (Simple linear interpolation by 2-axis simultaneous start)
Maximum frequency	2147483647 (200 kpps in pulses)
Positioning program	Sequence program, Table operation
Output type	FX5-16ET/ES-H: Transistor output (Sink type) FX5-16ET/ESS-H: Transistor output (Source type)
Pulse output instruction	—
Positioning instruction	DSZR, DDSZR, DVIT, DDVIT, DRVTBL, DRVMUL, DABS, PLSV, DPLSV, DRVI, DDRVI, DRVA, and DDRVA instructions
Power supply	5 V DC, 100 mA (internal power supply) 24 V DC, 125 mA (supplied from service power supply or external power supply)
Compatible CPU module	FX5U, FX5UC from Ver. 1.030 Connection with FX5UC requires FX5-CNV-IFC or FX5-C1PS-5V.
Number of connectable modules	FX5U, FX5UC: Up to 4 modules
External dimensions W × H × D (mm)	40 × 90 × 83
MASS (Weight): kg	Approx. 0.25

FX5-20PG-P type pulse train positioning module (transistor output)

FX5-20PG-D type pulse train positioning module (differential driver output)

◇ Features



- 1) By analyzing the positioning data in advance, the module can start the positioning at a higher speed than the normal positioning start.
- 2) It can easily draw the smooth path by combining linear interpolation, 2-axis circular interpolation, and continuous path control in a table-type program.
- 3) Acceleration/deceleration processing can be selected from two methods of trapezoidal and S-shaped acceleration/deceleration, and four kinds each of acceleration time and deceleration time can be set. In the case of S-shaped acceleration/deceleration, the S-character ratio can also be set.

◇ Specifications

Items	Specifications	
	FX5-20PG-P	FX5-20PG-D
Number of control axes	2 axes	
Control unit	mm, inch, degree, pulse	
Output type	Transistor	Differential driver
Command speed	200 kpps	5 Mpps
Pulse output	Output signal: PULSE/SIGN mode, CW/CCW mode, phase A/B (4 multiplication), phase A/B (1 multiplication) Output terminal: Transistor 5 to 24 V DC 50 mA or less	Differential driver equivalent to AM26C31
External I/O specifications	Input: READY/STOP/FLS/RLS/PG024/DOG/CHG terminals: 24 V DC 5 mA, PULSER A/PULSER B terminals: 5 V DC 14 mA Zero point signal PG05 terminal: 5 V DC 5 mA Output: CLEAR (deviation counter): 5 to 24 V DC 100 mA or less Circuit insulation: Photocoupler insulation	
Power supply	24 V DC +20%, -15% 120 mA (external power supply)	24 V DC +20%, -15% 165 mA (external power supply)
Compatible CPU module	FX5U, FX5UC: Ver. 1.050 or later Connection with FX5UC requires FX5-CNV-IFC or FX5-C1PS-5V.	
Number of occupied I/O points	8 points (Either input or output is available for counting.)	
Number of connectable modules	FX5U: Up to 16 modules FX5UC: Up to 16 modules, or up to 15 modules when using a powered I/O module	
External dimensions W × H × D (mm)	50 × 90 × 83	
MASS (Weight): kg	Approx. 0.2	

◇ Option

Connector for external devices (40-pin)

Model name	Type
A6CON1	Soldered type (straight protrusion)
A6CON2	Crimped type (straight protrusion)
A6CON4	Soldered type (both straight/inclined protrusion type)

External device connection connectors and connection cables etc. are not included with the product. Please arrange them by the customer.

Positioning control

FX3U-1PG type pulse output module

◆ Features



- 1) The module is equipped with 7 operation modes necessary for simple positioning control.
- 2) Pulse train of up to 200 kpps can be output.
- 3) Speed and target address can be changed during positioning operation to perform operation for each process.
- 4) Approximate S-curve acceleration/ deceleration is supported. Smooth high-speed operation can be performed.

◆ Specifications

Items	Specifications
Number of control axes	1 axis
Command speed	200 kpps (instruction unit can be selected from among 1 pps, cm/min, inch/min, and 10 deg/min)
Set pulse	-2,147,483,648 to 2,147,483,647 (Instruction unit can be selected from pulse, μm , mdeg, 10^{-4} inch. In addition, magnification can be set for position data.)
Pulse output	Output signal format: Forward rotation (FP)/reverse rotation (RP) pulse or pulse (PLS)/direction (DIR) can be selected. Pulse output terminal: Transistor output 5 to 24 V DC, 20 mA or less (photo-coupler isolation, with indication of operation by LED)
External input/output specification	Input: For STOP/DOG terminal, 24 V DC, 7 mA For zero-point signal PG0 terminal, 5 to 24 V DC, 20 mA or less Output: For each of FP (forward rotation), RP (reverse rotation), and CLR (clear) terminals, 5 to 24 V DC, 20 mA or less
Driving power	For input signal: 24 V DC, 40 mA For pulse output: 5 to 24 V DC, power consumption 35 mA or less
Control power	5 V DC, 150 mA (supplied from PLC via extension cable)
Compatible CPU module	FX5U, FX5UC, compatible from initial product Connection with FX5U or FX5UC requires FX5-CNV-BUS or FX5-CNV-BUSC.
Number of occupied input/output points	8 points (Either input or output is available for counting.)
Communication with PLC	Carried out by FROM/TO instruction via buffer memory (buffer memory can directly be specified)
Number of connectable modules	FX5U : Up to 8 modules when FX3U extension power supply modules are used Up to 6 modules when FX3U extension power supply modules are not used FX5UC : Up to 6 modules
External dimensions W × H × D (mm)	43 × 90 × 87
MASS (Weight): kg	Approx. 0.2

Advanced synchronous control

FX5-40SSC-S and FX5-80SSC-S type simple motion modules are intelligent function modules compatible with SSCNET III/H. It can use a servo motor to perform positioning control via SSCNET III/H compatible servo amplifier. For positioning control, refer to the relevant manual.

FX5-40SSC-S type simple motion module FX5-80SSC-S type simple motion module

◆ Features



FX5-40SSC-S and FX5-80SSC-S are equipped with the 4/8-axis positioning functions compatible with SSCNET III/H. By combining linear interpolation, 2-axis circular interpolation and continuous trajectory control in the program set with a table, a smooth trajectory can be easily drawn. In "synchronous control", "parameter for synchronous control" is set and synchronous control is started for each output axis to perform control in synchronization with the input axes (servo input axis, instruction generation axis*¹, and synchronous encoder axis).

*1: The instruction generation axis is used only for instruction generation. It can be controlled independently as an axis connected to a servo amplifier. (It is not counted as a control axis.)

◆ Specifications

Items		Specifications	
		FX5-40SSC-S	FX5-80SSC-S
Number of control axes		4 axes	8 axes
Operation cycle		0.888 ms/1.777 ms	
Interpolation function		Linear interpolation (maximum 4 axes), two-axis circular interpolation	
Control system		PTP (Point To Point) control, Trajectory control (both linear and arc), Speed control, Speed-position switching control, Position-speed switching control, Speed-torque control	
Acceleration/deceleration process		Trapezoidal acceleration/deceleration, S-curve acceleration/ deceleration	
Synchronous control	Input axis	Servo input axis, synchronous encoder axis, command generation axis	
	Output axis	Cam shaft	
Cam control	Number of registration* ²	Up to 64 cams	Up to 128 cams
	Cam data type	Stroke ratio data type, Coordinate data type	
	Cam auto-generation	Cam auto-generation for rotary cutter	
Control unit		mm, inch, degree, pulse	
Number of positioning data		600 data (positioning data No. 1 to 600)/axis (Can be set with MELSOFT GX Works3 or a sequence program.)	
Backup		Parameters, positioning data, and block start data can be saved on flash ROM (battery-less backup)	
Positioning control	Linear control	1-axis linear control, 2-axis linear interpolation control, 3-axis linear interpolation control, 4-axis linear interpolation control* ³ (Composite speed, Reference axis speed)	
	Fixed-pitch feed control	1-axis fixed-pitch feed, 2-axis fixed-pitch feed, 3-axis fixed-pitch feed, 4-axis fixed-pitch feed* ³	
	2-axis circular interpolation	Sub point designation, center point designation	
	Speed control	1-axis speed control, 2-axis speed control* ³ , 3-axis speed control* ³ , 4-axis speed control* ³	
	Speed-position switching control	INC mode, ABS mode	
	Position-speed switching control	INC mode	
	Current value change	Positioning data, Start No. for a current value changing	
	NOP instruction	Provided	
	JUMP instruction	Unconditional JUMP, Conditional JUMP	
	LOOP, LEND	Provided	
High-level positioning control	Block start, Condition start, Wait start, Simultaneous start, Repeated start		
Servo amplifier connection method		SSCNET III/H	
Maximum overall cable distance [m]		400	
Maximum distance between stations [m]		100	
24 V DC external current consumption		250 mA	
Compatible CPU module		Compatible with FX5U and FX5UC, from their first released products	
Number of occupied input/output points		8 points (Either input or output is available for counting.)	
Communication with PLC		Carried out by FROM/TO instruction via buffer memory (buffer memory can directly be specified)	
Number of connectable modules		FX5U: Up to 16 modules FX5UC: Up to 16 modules, or up to 15 modules when using a powered I/O module	
External dimensions W × H × D (mm)		50 × 90 × 83	
MASS (Weight): kg		Approx. 0.3	

*2: The number of registered cams varies depending on the memory capacity, cam resolution, and the number of coordinates.
*3: Only the reference axis speed is effective for the interpolation speed specification method.

Advanced synchronous control

memo

Network/Communication

MELSEC iQ-F Series can support not only high-speed networks like CC-Link but also other networks corresponding to control contents such as Ethernet, MODBUS, Sensor Solution, and PROFIBUS-DP. In addition, communication function to easily establish simple data link between MELSEC iQ-F Series and to RS-232C and RS-485 devices is also supported.

◇ CC-Link

Types	Contents	Total extension length or transmission distance	Station types	Compatible CPU module	
				FX5U	FX5UC
<p>CC-Link V2 (CC-Link V2 system supported by MELSEC iQ-F Series master)</p>	<ul style="list-style-type: none"> ● Outline This is a CC-Link V2 system where MELSEC iQ-F Series is used as master station. CC-Link V2 system can be established using just MELSEC iQ-F Series. Ver. 1.10 is also supported. ● Scale Remote I/O station: max. 14*1 modules Intelligent device station or remote device station: max. 14*1 modules ● Scope Distributed control and central management of lines, configuration of small-scale and high-speed network, etc. 	Max. 1200 m	Master station (FX5-CCL-MS) Master station (FX3U-16CCL-M) Intelligent device station (FX3U-64CCL)	○	○*2 ○*3 ○*3
<p>CC-Link V2 (CC-Link V2 system with MELSEC iQ-R Series master)</p>	<ul style="list-style-type: none"> ● Outline MELSEC iQ-F series can be connected as an intelligent device station to the CC-Link V2 system in which is the MELSEC iQ-R series etc. is the master station. ● Scale Max. 64 modules ● Scope Distributed control and central management of lines, information transfer from the host network, etc. 	Max. 1200 m	Intelligent device station (FX5-CCL-MS) Intelligent device station (FX3U-64CCL)	○	○*2 ○*3
<p>CC-Link IE Field</p> <p>For star connections</p>	<ul style="list-style-type: none"> ● Outline MELSEC iQ-F Series can be connected as intelligent device stations for the CC-Link IE field network system using MELSEC iQ-R series as master station. ● Scale Max. 121 modules (1 master station, 120 slave stations) ● Scope Distributed control and central management of lines, information transfer from the host network, etc. 	Line topology: 12000 m (With 121 modules connected) Star topology: Depending on the system configuration Ring topology: 12100 m (With 121 modules connected)	Intelligent device station (FX5-CCLIEF)	○	○*2
<p>CC-Link IE Field Network Basic</p>	<ul style="list-style-type: none"> ● Outline CC-Link IE Field Network Basic is an FA network utilizing general-purpose Ethernet. Data communication is performed periodically (cyclic transmission) using a link device between the master station and slave station. ● Scale FX5U, FX5UC: Up to 16 modules FX5-ENET: Up to 32 modules ● Scope Distributed control and centralized management of lines, and exchange of information with upper network 	Depending on the system configuration	Master station (FX5U, FX5UC) Master station (FX5-ENET)	○	○ ○*2

*1: This number is applicable when FX5-CCL-MS is used as the master station. The maximum number is 8 when FX3U-16CCL-M is used as the master station.
 *2: Connection with FX5UC requires FX5-CNV-IFC or FX5-C1PS-5V.
 *3: Connection with FX5U/FX5UC requires FX5-CNV-BUS or FX5-CNV-BUSC.

◇ Ethernet

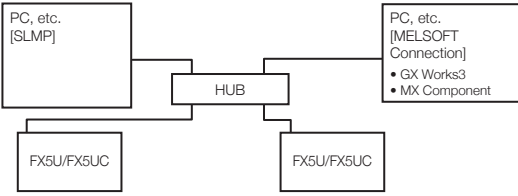
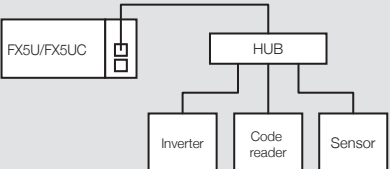
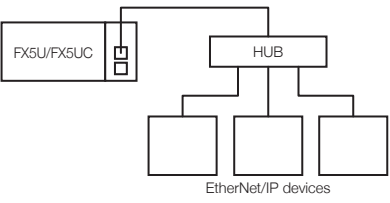
Types	Contents	Total extension length or transmission distance	Compatible CPU module	
			FX5U	FX5UC
<p>FX5U/FX5UC CPU Module</p> 	<ul style="list-style-type: none"> ● Outline Ethernet port is built in. Setting is enabled from GX Works3. ● Protocol type Compatible with CC-Link IE Field Network Basic, MELSOFT connection, SLMP (3E frame), socket communications, communication protocol support, FTP server, MODBUS/TCP communication, SNTIP client, Web server (HTTP), simple CPU communication function ● Scale 1:n ● Scope Distributed control of lines, central management, data collection, program maintenance, etc. 	—	○	○
<p>FX5-ENET</p> 	<ul style="list-style-type: none"> ● Outline Intelligent function module with built-in Ethernet port. Settings can be configured from GX Works3. ● Protocol type Compatible with CC-Link IE Field Network Basic, socket communication ● Scale 1:n ● Scope Distributed control of lines, central management, data collection, etc. 	—	○	○*
<p>FX5-ENET/IP</p> 	<ul style="list-style-type: none"> ● Outline Intelligent function module with built-in Ethernet port. Settings can be configured from GX Works3 and EtherNet/IP Configuration Tool for FX5-ENET/IP. ● Protocol type EtherNet/IP communication, socket communication ● Scale 1:n ● Scope Distributed control of lines, central management, data collection, etc. 	—	○	○*

*: Connection with FX5UC requires FX5-CNV-IFC or FX5-C1PS-5V.

◇ Simple CPU communication

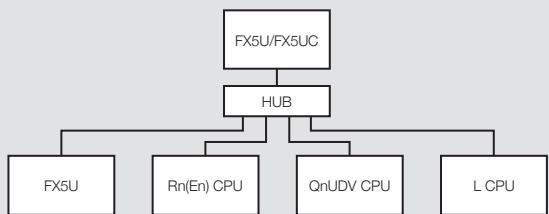
Types	Contents	Total extension length or transmission distance	Compatible CPU module	
			FX5U	FX5UC
<p>Simple CPU communication (with built-in Ethernet port)</p> 	<ul style="list-style-type: none"> ● Outline Transmit and receive data from a specified device at a specified timing using the built-in Ethernet function. Settings can be configured from GX Works3. ● Scale Max. 16 modules ● Scope Distributed control of lines, central management, data collection, etc. 	—	○	○

◇ MODBUS

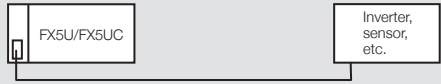
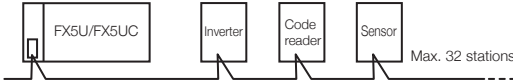
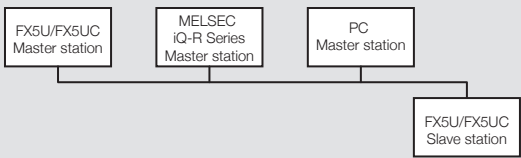
Types	Contents	Total extension length or transmission distance	Compatible CPU module	
			FX5U	FX5UC
<p>FX5U/FX5UC CPU Module (built-in RS-485 port), FX5-485-BD</p> 	<ul style="list-style-type: none"> ● Outline Connectable from RS-485 to MODBUS by using FX5 as master or slave. ● Scale Max. 32 stations ● Scope Configuration of small-size and high-speed network, etc. 	Max. 50 m	○	○*
<p>FX5-232ADP, FX5-232-BD</p> 	<ul style="list-style-type: none"> ● Outline Connectable from RS-232C to MODBUS by using FX5 as master or slave. ● Scale 1:1 ● Scope Data transfer from PCs, code readers, printers, various measurement devices, etc. 	Max. 15 m	○	○*
<p>FX5-485ADP</p> 	<ul style="list-style-type: none"> ● Outline Connectable from RS-485 to MODBUS by using FX5 as master or slave. ● Scale Max. 32 stations ● Scope Distributed control of lines, central management, etc. 	Max. 1200 m	○	○
<p>FX5U/FX5UC CPU module (with built-in Ethernet port)</p> 	<ul style="list-style-type: none"> ● Outline Connections with the FX5 set as the slave station are possible via Ethernet connection to various MODBUS/TCP master devices. ● Scale Up to 8 connections ● Scope Distributed control of lines, central management, data collection, program maintenance, etc. 	—	○	○

*: No expansion board can be used in FX5UC.

◇ Sensor Solution

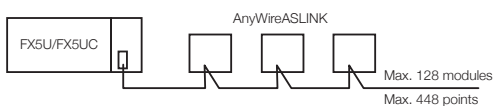
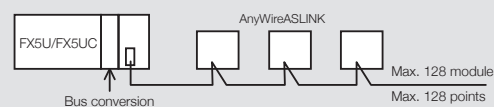
Types	Contents	Total extension length or transmission distance	Compatible CPU module	
			FX5U	FX5UC
<p>FX5-ASL-M</p> 	<ul style="list-style-type: none"> ● Outline This is the master module of the AnyWireASLINK system. A sensor saving wiring system of AnyWireASLINK system can be constructed. ● Scale Max. 128 modules ● Scope Distributed control of lines, central management of sensors, etc. 	Max. 200 m	○	○*1
<p>FX3U-128ASL-M</p> 	<ul style="list-style-type: none"> ● Outline This is the master module of the AnyWireASLINK system. A sensor saving wiring system of AnyWireASLINK system can be constructed. ● Scale Max. 128 modules ● Scope Distributed control of lines, central management of sensors, etc. 	Max. 200 m	○*2	○*2

*1: Connection with FX5UC requires FX5-CNV-IFC or FX5-C1PS-5V.

*2: Connection with FX5U/FX5UC requires FX5-CNV-BUS or FX5-CNV-BUSC.

◇ PROFIBUS-DP

Types	Contents	Total extension length or transmission distance	Compatible CPU module	
			FX5U	FX5UC
<p>FX5-DP-M</p>	<ul style="list-style-type: none"> ● Outline This PROFIBUS-DP system uses the MELSEC iQ-F Series as the master station. Using this product makes it possible to incorporate PROFIBUS-compatible slave devices used throughout Europe into the system. ● Scale Up to 64 modules ● Scope Distributed control and centralized management of lines, exchange of information with upper network, etc. 	Up to 4800 m when repeaters are used	○	○*2
<p>FX3U-32DP</p>	<ul style="list-style-type: none"> ● Outline Connectable as a slave station to PROFIBUS-DP systems using the MELSEC iQ-F Series as the master station. ● Scale Up to 64 modules ● Scope Distributed control and centralized management of lines, exchange of information with upper network, etc. 	Up to 4800 m when repeaters are used	○*3	○*3

* 1: Any station number can be set for the master station.
 * 2: Connection with FX5UC requires FX5-CNV-IFC or FX5-C1PS-5V.
 * 3: Connection with FX5U/FX5UC requires FX5-CNV-BUS or FX5-CNV-BUSC.

◇ General-purpose communication/peripheral device communication

Types	Contents	Distance	Compatible CPU module	
			FX5U	FX5UC
<p>RS-232C Communication (Communication between FX5 and RS-232C device)</p>	<ul style="list-style-type: none"> ● Outline Data can be transferred from various devices with built-in RS-232C interface by non-protocol communication. ● Scale 1:1 ● Scope Data transfer from PCs, code readers, printers, various measurement devices, etc. 	Max. 15 m	○	○*
<p>RS-485 Communication (Communication between FX5 and RS-485 device)</p>	<ul style="list-style-type: none"> ● Outline Data can be transferred from various devices with built-in RS-485 interface by non-communication protocol. ● Scale 1:1 (1:n) ● Scope Data transfer from PCs, code readers, printers, various measurement devices, etc. 	Max. 50 m or 1200 m	○	○*
<p>Addition of peripheral device connection port (Connection between FX5 and peripheral device)</p>	<ul style="list-style-type: none"> ● Outline RS-232C or RS-422 port (GOT port) can be added. ● Scale 1:1 ● Scope Simultaneous connection of two HMI, etc. 	[RS-422] Depends on peripheral devices to be connected. [RS-232C] Max.15 m	○	○*

*: No expansion board can be used in FX5UC.

◇ Data link

Types	Contents	Total extension length or transmission distance	Compatible CPU module	
			FX5U	FX5UC
<p>N:N network (n:n connection)</p>	<ul style="list-style-type: none"> ● Outline Enabling a simple data link between FX5 and FX3. ● Scale Max. 8 modules ● Scope Distributed control and central management of lines, etc. 	Max. 50 m or 1200 m	○	○*
<p>Parallel link</p>	<ul style="list-style-type: none"> ● Outline With two FX5 PLCs connected, devices can be linked to each other. The data link is automatically updated between the two FX5 PLCs. ● Scale 1:1 ● Scope Distributed control and centralized control of small-scale lines 	Max. 50 m or 1200 m	○	○*
<p>MC protocol (1: n connection to external device)</p>	<ul style="list-style-type: none"> ● Outline FX5 can be connected as a slave station by setting an external device (PC, etc.) as a master station. Frame 1C: Compatible to Type 1/Type 4 Frame 3C: Compatible to Type 1/Type 4 Frame 4C: Compatible to Type 1/Type 4/Type 5 ● Scale 1:n (n = max. 16 modules) ● Scope Distributed control and central management of lines, etc. 	Max. 50 m or 1200 m	○	○*
<p>MC protocol (1:1 connection to external device)</p>	<ul style="list-style-type: none"> ● Outline FX5 can be connected as a slave station by setting an external device (PC, etc.) as a master station. Frame 1C: Compatible to Type 1/Type 4 Frame 3C: Compatible to Type 1/Type 4 Frame 4C: Compatible to Type 1/Type 4/Type 5 ● Scale 1:1 ● Scope Data collection, central management, etc. 	Max. 15 m	○	○*

*: No expansion board can be used in FX5UC.

CC-Link IE Field

CC-Link IE Field is a high speed (1Gbps), high capacity open field network using Ethernet (1000BASE-T). FX5-CCLIEF is an intelligent function module to connect the FX5 CPU module as an intelligent device station to a CC-Link IE Field network.

FX5-CCLIEF type CC-Link IE Field Network Intelligent device station module

◆ Features



MELSEC iQ-F Series modules can be connected as intelligent device stations in the CC-Link IE Field network.

◆ Specifications

Items		Specifications
Station type		Intelligent device station
Station number		1 to 120 (set by parameter or program)
Communication speed		1 Gbps
Network topology		Line topology, star topology (coexistence of line topology and star topology is also possible), and ring topology
Maximum station-to-station distance		100 m (conforms to ANSI/TIA/EIA-568-B (Category 5e))
Cascade connection		Max. 20 stages
Communication method		Token passing
Maximum number of link points*1	RX	384 points, 48 bytes
	RY	384 points, 48 bytes
	RWr	1024 points, 2048 bytes*2
	RWw	1024 points, 2048 bytes*2
Compatible CPU module		FX5U, FX5UC*3 from Ver. 1.030
Applicable engineering tool		GX Works3 Ver. 1.025B or later
Number of occupied I/O points		8 points (Either input or output is available for counting.)
Communication with PLC		Done by FROM/TO instruction via buffer memory (buffer memory can be directly specified)
Number of connectable modules		FX5U, FX5UC: Max. 1 module
Power supply		5 V DC 10 mA (internal power supply) 24 V DC 230 mA (external power supply)
External dimensions W × H × D (mm)		50 × 90 × 103
MASS (Weight): kg		Approx. 0.3

*1: The maximum number of link points that a master station can assign to one FX5-CCLIEF module.

*2: 256 points (512 bytes) when the mode of the master station is online (High-Speed Mode).

*3: Connection with the FX5UC requires FX5-CNV-IFC or FX5-C1PS-5V.

◆ Network topology

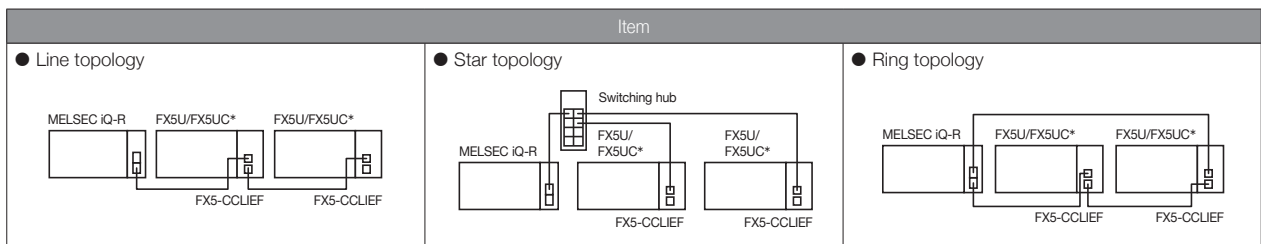

*: Connection with FX5UC requires FX5-CNV-IFC or FX5-C1PS-5V.

CC-Link V2

CC-Link V2 is an open network enabling connection of various FA equipment.
A master module to set MELSEC iQ-F Series as CC-Link master, as well as an interface to connect as a CC-Link slave are available.

FX5-CCL-MS type CC-Link system master/intelligent device module

◇ Features



- 1) Since this module has both functions, the master station and intelligent device station, it can be used as either of them by switching with parameters.
- 2) When using the module as an intelligent device station, the transmission speed can be set to auto-tracking. Since the module tracks the transmission speed of the master station automatically, there is no setting mistake.
- 3) Supporting the other station access function, the module can use GX Works3 connected to the local station to monitor program writing and reading and devices of PLCs of other stations in the same network. This function thus eliminates the need for connecting GX Works3 to individual MELSEC iQ-F series and reduces man-hours.

◇ Specifications

Item		Specifications									
Compatible functions		Master station or intelligent device station									
CC-Link supported version		Ver. 2.00 and Ver. 1.10									
Transmission Speed		<ul style="list-style-type: none"> • Master station: 156 kbps/625 kbps/2.5 Mbps/5 Mbps/10 Mbps • Intelligent device station: 156 kbps/625 kbps/2.5 Mbps/5 Mbps/10 Mbps/auto-tracking 									
Station number		<ul style="list-style-type: none"> • Master station: 0 • Intelligent device station: 1 to 64 									
Connectable station type (at the time of master station)		Remote I/O station, remote device station, intelligent device station (local station and standby master station cannot be connected)									
Maximum overall cable length		1200 m (varies depending on transmission speed)									
Maximum number of connected stations (at the time of master station)		<ul style="list-style-type: none"> • Remote I/O stations: 14 maximum (The total number of I/O points of remote I/O station is 448 or less.) • The total number of remote device stations + intelligent device stations: 14 maximum (The total number of I/O points of intelligent device station + remote device station is 448 or less.) 									
Number of occupied stations (at the time of intelligent device station)		1 to 4 stations (changed according to the setting of engineering tool)									
Maximum number of link points per system*5	CC-Link Ver. 1	<ul style="list-style-type: none"> • Remote I/O (RX, RY): 896 points (remote I/O station: 448 points*3 + remote device stations and intelligent device stations: 448 points) • Remote register (RWw): 56 points • Remote register (RWr): 56 points 									
	CC-Link Ver. 2	<ul style="list-style-type: none"> • Remote I/O (RX, RY): 896 points (remote I/O station: 448 points*3 + remote device stations and intelligent device stations: 448 points) • Remote register (RWw): 112 points • Remote register (RWr): 112 points 									
		CC-Link Ver. 1		CC-Link Ver. 2							
Extended cyclic setting				Single		Double		Quadruple		Octuple	
Number of link points*5	Number of occupied stations	Remote I/O	Remote register	Remote I/O	Remote register	Remote I/O	Remote register	Remote I/O	Remote register	Remote I/O	Remote register
	1 station occupied	RX, RY: 32 points (16 points)*4	RWw: 4 points RWr: 4 points	RX, RY: 32 points (16 points)*4	RWw: 4 points RWr: 4 points	RX, RY: 32 points (16 points)*4	RWw: 8 points RWr: 8 points	RX, RY: 64 points (48 points)*4	RWw: 16 points RWr: 16 points	RX, RY: 128 points (112 points)*4	RWw: 32 points RWr: 32 points
	2 stations occupied	RX, RY: 64 points (48 points)*4	RWw: 8 points RWr: 8 points	RX, RY: 64 points (48 points)*4	RWw: 8 points RWr: 8 points	RX, RY: 96 points (80 points)*4	RWw: 16 points RWr: 16 points	RX, RY: 192 points (176 points)*4	RWw: 32 points RWr: 32 points	RX, RY: 384 points (368 points)*4	RWw: 64 points RWr: 64 points
	3 stations occupied	RX, RY: 96 points (80 points)*4	RWw: 12 points RWr: 12 points	RX, RY: 96 points (80 points)*4	RWw: 12 points RWr: 12 points	RX, RY: 160 points (144 points)*4	RWw: 24 points RWr: 24 points	RX, RY: 320 points (304 points)*4	RWw: 48 points RWr: 48 points		
	4 stations occupied	RX, RY: 128 points (112 points)*4	RWw: 16 points RWr: 16 points	RX, RY: 128 points (112 points)*4	RWw: 16 points RWr: 16 points	RX, RY: 224 points (208 points)*4	RWw: 32 points RWr: 32 points	RX, RY: 448 points (-)*4	RWw, RWr: 64 points (-)*4		
Transmission cable		CC-Link Ver. 1.10 compatible CC-Link dedicated cable									
Compatible CPU module		FX5U, FX5UC: Ver. 1.050 or later Connection with FX5UC requires FX5-CNV-IFC or FX5-C1PS-5V.									
Applicable engineering tool		GX Works3 Ver. 1.035M or later									
Communication method		Broadcast polling method									
Transmission format		HDLC compliant									
Error control system		CRC (X ¹⁶ + X ¹² + X ⁵ + 1)									
Number of occupied I/O points		8 points (Either input or output is available for counting.)									
Number of connectable modules		One module can be connected to CPU module for each station type • Master station: 1 module*1 • Intelligent device station: 1 module*2									
Power supply		24 V DC +20%, -15% 100 mA (external power supply)									
Accessories		FX2NC-100MPCB type power cable (1 m, 3-wire) Ver. 1.10 compatible CC-Link dedicated cable terminating resistor (2) 110 Ω 1/2 W (color code: brown, brown, brown) Dust proof protection sheet (1)									
External dimensions W × H × D (mm)		50 × 90 × 83									
MASS (Weight): kg		Approx. 0.3									

* 1: When using the FX5-CCL-MS as the master station, it cannot be used together with the FX3U-16CCL-M.
* 2: When using the FX5-CCL-MS as the intelligent device station, it cannot be used together with the FX3U-64CCL.
* 3: The number of remote I/O points that can be used per system varies depending on the number of input/output points of the extension device.
For the limit of the number of I/O points, refer to the following manual.
→ MELSEC iQ-F FX5U User's Manual (Hardware)
→ MELSEC iQ-F FX5UC User's Manual (Hardware)
* 4: The numbers in parentheses are the points that can be used when the module is an intelligent device station.
* 5: Number of links with FX5U/FX5UC CPU module Ver. 1.100 or later. GX Works3 Ver. 1.047Z or later required. For details on the number of links with FX5U/FX5UC CPU module earlier than Ver. 1.100, refer to the following manual.
→ MELSEC iQ-F FX5 User's Manual (CC-Link)

FX3U-16CCL-M type CC-Link master module

◆ Features



- 1) A master module setting MELSEC iQ-F Series as master station of CC-Link.
- 2) Up to 8 remote I/O stations and up to 8 remote device stations or intelligent device stations can be connected to a master station.

◆ Specifications

Items		Specifications											
Supported functions		Master station function (No local station and standby master station functions)											
CC-Link compatible version		Ver. 2.00 compliance (Ver. 1.10 compatible at the time of setting extension cyclic to 1 time)											
Transmission speed		156 kbps/625 kbps/2.5 Mbps/5 Mbps/10 Mbps (setting by a rotary switch)											
Station No.		0 (setting by a rotary switch)											
Connectable station type		Remote I/O station, remote device station, intelligent device station (local station and standby master station cannot be connected)											
Max. cable extension length		1,200 m (varies depending on the transmission speed.)											
Max. no. of connection stations		Max. 16 stations • Remote I/O stations: 8 maximum (Each station occupies 32 I/O points of the PLC.) • Remote device stations + Intelligent device stations: 8 maximum (The total number of RX/Ry points is 256 or less.)											
Max. no of I/O points per system		[FX5U/FX5UC] The total connectable no. of (1) + (2) points below is 512 or less. (1) (No. of PLC actual I/O points) + (No. of occupied intelligent function module points) + (Occupied FX3U-16CCL-M points: 8 points) ≤ 256 (2) (32 × No. of remote I/O stations) ≤ 256											
		CC-Link Ver. 1.10				CC-Link Ver. 2.00							
Extension cyclic setting		—											
No. of occupied stations		Remote I/O		Remote register		Remote I/O		Remote register		Remote I/O		Remote register	
One station occupied		RX: 32 points RY: 32 points	RWw: 4 points RWr: 4 points	RX: 32 points RY: 32 points	RWw: 4 points RWr: 4 points	RX: 32 points RY: 32 points	RWw: 8 points RWr: 8 points	RX: 64 points RY: 64 points	RWw: 16 points RWr: 16 points	RX: 128 points RY: 128 points	RWw: 32 points RWr: 32 points		
Two stations occupied		RX: 64 points RY: 64 points	RWw: 8 points RWr: 8 points	RX: 64 points RY: 64 points	RWw: 8 points RWr: 8 points	RX: 96 points RY: 96 points	RWw: 16 points RWr: 16 points	RX: 192 points RY: 192 points	RWw: 32 points RWr: 32 points				
Three stations occupied		RX: 96 points RY: 96 points	RWw: 12 points RWr: 12 points	RX: 96 points RY: 96 points	RWw: 12 points RWr: 12 points	RX: 160 points RY: 160 points	RWw: 24 points RWr: 24 points						
Four stations occupied		RX: 128 points RY: 128 points	RWw: 16 points RWr: 16 points	RX: 128 points RY: 128 points	RWw: 16 points RWr: 16 points	RX: 224 points RY: 224 points	RWw: 32 points RWr: 32 points						
Transmission cable		CC-Link specific cable, CC-Link specific high-performance cable, Ver. 1.10 compatible CC-Link specific cable											
RAS function		Automatic return function, slave separating function, abnormal detection by link special relay/register, slave station refresh/Forced clear settings at the time of PLC CPU stop, and cyclic data consistency function											
Compatible CPU module		Supported from the first product of FX5U or FX5UC Connection with FX5U or FX5UC requires FX5-CNV-BUS or FX5-CNV-BUSC.											
No. of occupied I/O points		8 points (countable either by input or output)											
Communication with PLC		Done by FROM/TO instruction via buffer memory (buffer memory can be directly specified)											
No. of connectable modules		FX5U, FX5UC: Max. 1 module*											
External power supply	Power supply voltage/ Current consumption	24 V DC +20%/-15% ripple (p-p) within 5% (Electricity supplied from terminal block for power supply)/240 mA											
Accessories		Terminal resistors • For standard cable: 110 Ω 1/2 W (Color code, brown/brown/brown) 2 pcs. • For high-performance cable: 130 Ω 1/2 W (Color code, brown/orange/brown) 2 pcs. Special block No. label											
External dimensions W × H × D (mm)		55 × 90 × 87											
MASS (Weight): kg		Approx. 0.3											

*: When using the FX3U-16CCL-M, it cannot be used together with the FX5-CCL-MS used as the master station.

◇ Example of system configuration with FX5U

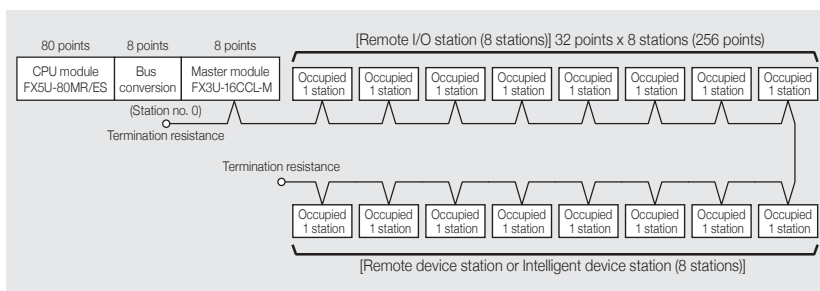

The maximum number of remote I/O stations to be connected is 8 when connecting 80-point type CPU module and FX3U-16CCL-M. The maximum number of remote I/O stations to be connected is less than 8 when the total number of points exceeds the maximum I/O points (512 points) due to the connection of I/O modules and intelligent function modules.

FX3U-64CCL type CC-Link interface module

◇ Features



MELSEC iQ-F Series can be connected as intelligent device stations of CC-Link.

◇ Specifications

Items		Specifications							
Isolation type		Photocoupler isolation							
CC-Link compatible version		Ver. 2.00 (Ver. 1.10 compliance at the time of setting extension cyclic to 1 time; Buffer memory FX2N-32CCL compatibility also selectable)							
Station types		Intelligent device station							
Station No.		1 to 64 (setting by a rotary switch)							
No. of occupied stations/ Extension cyclic setting		Occupied 1 to 4 stations, set to 1 to 8 times (setting by a rotary switch). Refer to the table below for the details of allowable range.							
Transmission speed		156 kbps/625 kbps/2.5 Mbps/5 Mbps/10 Mbps (setting by a rotary switch)							
Transmission cable		Ver. 1.10 compatible CC-Link specific cable, CC-Link specific high-performance cable							
		CC-Link Ver. 1.10				CC-Link Ver. 2.00			
No. of link points	Extension cyclic setting	Single		Double		Quadruple		Octuple	
	No. of occupied stations*1	Remote I/O	Remote register	Remote I/O	Remote register	Remote I/O	Remote register	Remote I/O	Remote register
	One station occupied	RX: 32 points RY: 32 points	RWw: 4 points RWr: 4 points	RX: 32 points RY: 32 points	RWw: 8 points RWr: 8 points	RX: 64 points RY: 64 points	RWw: 16 points RWr: 16 points	RX: 128 points RY: 128 points	RWw: 32 points RWr: 32 points
	Two stations occupied	RX: 64 points RY: 64 points	RWw: 8 points RWr: 8 points	RX: 96 points RY: 96 points	RWw: 16 points RWr: 16 points	RX: 192 points RY: 192 points	RWw: 32 points RWr: 32 points		
	Three stations occupied	RX: 96 points RY: 96 points	RWw: 12 points RWr: 12 points	RX: 160 points RY: 160 points	RWw: 24 points RWr: 24 points				
Four stations occupied	RX: 128 points RY: 128 points	RWw: 16 points RWr: 16 points	RX: 224 points RY: 224 points	RWw: 32 points RWr: 32 points					
Compatible CPU module		Supported from the first product of FX5U or FX5UC Connection with FX5U or FX5UC requires FX5-CNV-BUS or FX5-CNV-BUSC.							
No. of occupied I/O points		8 points (countable either by input or output)							
Communication with PLC		Done by FROM/TO instruction via buffer memory (buffer memory can be directly specified)							
No. of connectable modules		FX5U, FX5UC: Max. 1 module*2							
External power supply	Power supply voltage/ Current consumption	24 V DC +20%/-15% ripple (p-p) within 5% (Electricity supplied from terminal block for power supply)/220 mA							
External dimensions W x H x D (mm)		55 x 90 x 87							
MASS (Weight): kg		Approx. 0.3							

*1: RX/Ry for a high-order word of the last station of "Remote I/O" points is occupied as a system area.
*2: When using the FX3U-64CCL, it cannot be used together with the FX5-CCL-MS used as the intelligent device station.

Ethernet

Connecting FX5 to LAN (Local Area Network) via Ethernet enables various data communications and program maintenance.

Built-in Ethernet communication

◆ Features

- 1) The built-in Ethernet port can be used to connect to a PC or other device. In addition, the Ethernet communication port can handle seamless SLMP communication with the upper-level device.
- 2) Monitors and diagnoses the CPU module using a Web browser via connected network. Connect not only from a general-purpose browser on an Ethernet-connected PC but also from any general-purpose browser on a tablet or smartphone connected to an Ethernet network.

◆ Communication Specifications

Items		Specifications
		FX5U / FX5UC
Data transmission speed		100/10 Mbps
Communication mode		Full duplex/Half duplex*1
Interface		RJ45 connector
Transmission method		Base band
Maximum segment length (The distance between hub and node)		100 m
Cascade connection	100BASE-TX	Max. 2 stages*2
	10BASE-T	Max. 4 stages*2
Supported protocol		CC-Link IE Field Network Basic, MELSOFT connection, SLMP (3E frame), socket communications, communication protocol support, FTP server, MODBUS/TCP communication, SNMP client, Web server (HTTP), simple CPU communication function
No. of connections		Total of 8 connections*3*4 (Up to 8 external devices are accessible to one CPU module at a time.)
Hub*1		A hub having 100BASE-TX or 10BASE-T port can be used.
IP address*5		Initial value: 192.168.3.250
Isolation		Pulse transformer isolation
Cable used*6	When connecting 100BASE-TX	Ethernet standard-compatible cable Category 5 or higher (STP cable)
	When connecting 10BASE-T	Ethernet standard-compatible cable Category 3 or higher (STP cable)

● Outline of Functions

MELSOFT connection

The CPU module is connected to an engineering tool (GX Works3) without using a hub but only by one Ethernet cable. This connection communicates by only specifying the connection destination without setting an IP address.

Communication by SLMP

SLMP (SeamLess Message Protocol) can read/write the device data of PLC from the PC via the Ethernet communication (up to 8 connections).

Remote maintenance

Remote maintenance enables comfortable remote maintenance and monitoring. Realizes flexible maintenance using Internet regardless of where base is located!

VPN connection construction

VPN router: Relaying communication device by encrypting data

VPN (Virtual Private Network)*

This is a technology that connects networks by encrypting the communication contents. In combination with the Internet, VPN allows remotely separated networks to be accessed as if connected with each other via LAN.

*: A VPN connection service support partner will help you support VPN system construction.

Vision system

An image inspection device with a high cost performance can be configured by combining FX5U and EZ-700 series into an all-in-one system.

Main functions of Vision System

- Presence Inspection
- Burr Inspection
- Number Counting
- Fault Test
- Positioning
- Code Reading
- Dimensional Inspection
- Inclination Inspection
- Character Recognition, etc.
- Flaw/Stain Inspection
- Foreign Matter Inspection

Simple CPU communication

Allows data communications between specified devices at the specified timing just by setting simple parameters from GX Works3.

*1: IEEE802.3x flow control is not supported.
 *2: No. of connectable stages when using a repeater hub. For the no. of connectable stages when a switching hub is in use, check the switching hub specification.
 *3: The first device for MELSOFT connection is not included in the number of connections. (The second and the following devices are included.)
 *4: The CC-Link IE field network Basic, FTP server, SNMP client, Web server and simple CPU communication function are not included in the number of connections.
 *5: If the first octet is 0 or 127, a parameter error (2222H) will occur. (Example: 0.0.0.0, 127.0.0.0, etc.)
 *6: A straight cable can be used. If a personal computer or GOT and CPU module are directly connected, a cross cable can be used.

FX5-ENET type Ethernet module

◆ Features



- 1) Master module for using the MELSEC iQ-F Series as a CC-Link IE Field Network Basic master station. Co-existence with general-purpose Ethernet is also possible.
- 2) Up to 32 connectable slave stations for CC-Link IE Field Network Basic, with control for up to 2048 link points for RX/Ry, and 1024 points for RWr/RWw within the same network.
- 3) Grouping of slave stations for CC-Link IE Field Network Basic with configuration of a group number, with cyclic transmission possible for each group. Grouping stations according to the slave station standard response time makes it possible to suppress the influence of differences in the standard response times of each slave station.

◆ Specifications

Items		Specifications		
CC-Link IE Field Network Basic	Station type	Master station		
	Maximum number of connectable stations*1	32		
	Number of stations occupied by a slave station	1 to 4		
	Number of slave station groups	2		
	Maximum number of link points per network	RX	2048 points	
		Ry	2048 points	
		RWr	1024 points	
		RWw	1024 points	
	Maximum number of link points per station	Master station	RX	2048 points
			Ry	2048 points
			RWr	1024 points
			RWw	1024 points
		Slave station*2	RX	64/128/192/256 points
			Ry	64/128/192/256 points
	RWr	32/64/96/128 points		
	RWw	32/64/96/128 points		
UDP port number used in the cyclic transmission	61450			
UDP port number used in automatic detection of connected devices	Master station: An unused port number is assigned automatically. Slave station: 61451			
Transmission specifications	Data transfer speed	100 Mbps		
	Interface	RJ45 connector		
	Maximum station-to-station distance	100 m		
	Overall cable distance	Depends on the system configuration		
Number of cascade connections	100BASE-TX	When using a switching hub, check the number of cascaded stages with the manufacturer of the hub to be used.		
		Star topology		
Hub*3	Hubs with 100BASE-TX ports*4 can be used.			
Connection cable*5	100BASE-TX	Ethernet standard-compatible cable Category 5 or higher (STP cable)		
General-purpose Ethernet communication	Transmission specifications	Data transfer speed	100/10 Mbps	
		Communication mode	Full-duplex or half-duplex*3	
		Transmission method	Base band	
		Interface	RJ45 connector	
		Maximum segment length (Maximum distance between hub and node)	100 m*6	
	Number of cascade connections	100BASE-TX 10BASE-T	Max. 2 stages*7	
			Max. 4 stages*7	
	Supported protocol	Socket communication		
	Number of connections	Total of 32 connections (Up to 32 external devices can access one FX5-ENET module at the same time.)		
	Hub*3	Hubs with 100BASE-TX or 10BASE-T ports*8 can be used.		
Connection cable*5	100BASE-TX 10BASE-T	Ethernet standard-compatible cable Category 5 or higher (STP cable)		
		Ethernet standard-compatible cable Category 3 or higher (STP/UTP cable)		
Number of ports	2*9			
Compatible CPU module	FX5U, FX5UC: Ver. 1.110 or later Connection with FX5UC requires FX5-CNV-IFC or FX5-C1PS-5V.			
Number of occupied I/O points	8 points (Either input or output is available for counting.)			
Number of connectable modules	FX5U, FX5UC: Up to 1 module			
Power supply	24 V DC, 110 mA (internal power supply)			
External dimensions W × H × D (mm)	40 × 90 × 83			
MASS (Weight): kg	Approx. 0.2			

*1: Maximum number of connected slave stations that FX5-ENET (master station) can manage. However, the maximum number of connectable modules varies depending on the number of stations occupied by a slave station.

*2: Value for 1-station occupation, 2-station occupation, 3-station occupation, or 4-station occupation.

*3: IEEE802.3x flow control is not supported.

*4: The ports must comply with the IEEE802.3 100BASE-TX standards.

*5: A straight/cross cable can be used.

*6: For maximum segment length (length between hubs), consult the manufacturer of the hub used.

*7: This number applies when a repeater hub is used. When using a switching hub, check the number of cascaded stages with the manufacturer of the hub to be used.

*8: The ports must comply with the IEEE802.3 100BASE-TX or IEEE802.3 10BASE-T standards.

*9: Because the IP address is shared by two ports, only one address can be set.

EtherNet/IP

CIP communication protocol achieves a seamless communication with EtherNet/IP Network.

FX5-ENET/IP type Ethernet module

◆ Features



- 1) Module for connecting the MELSEC iQ-F Series to EtherNet/IP Network and general-purpose Ethernet. Co-existence with EtherNet/IP and general-purpose Ethernet is also possible.
- 2) Not only setting of EtherNet/IP communication, but also detection of EtherNet/IP devices on the network and on-line setting of EtherNet/IP communication is possible.
- 3) Settings can be configured with the following software:
 - GX Works3 (Ver. 1.050C or later)
 - EtherNet/IP Configuration Tool for FX5-ENET/IP (Ver. 1.00A or later)

◆ Specifications

Items		Specifications	
EtherNet/IP communications	Class 1 communications	Communication format	Standard EtherNet/IP
		Number of connections	32
		Communication data size	1444 bytes (per connection)
		Connection type	Point-to-point, multicast
		RPI (communication cycle)	2 to 60000 ms
	Class 3 communications	PPS (communication processing performance)	3000 pps (case of 128 bytes)
		Communication format	Standard EtherNet/IP
		Number of connections (number of simultaneous executions)	32*1
	UCMM communications	Communication data size	1414 bytes (per connection)*2
		Connection type	Point-to-point
	Transmission specifications	Communication format	Standard EtherNet/IP
		Number of connections (number of simultaneous executions)	32*1
		Communication data size	1414 bytes*2
		Connection type	Point-to-point
		Data transmission speed	100 Mbps
		Communication mode	Full-duplex
		Transmission method	Base band
	Network topology	IP version	IPv4 is supported.
		Maximum segment length	100 m*3
Number of cascade connections		100BASE-TX: 2 levels maximum*4	
Hub*5		*6	
General-purpose Ethernet communication	Connection cable*7	100BASE-TX	
	Transmission specifications	Data transfer speed	100/10 Mbps
		Communication mode	Full-duplex or half-duplex*5
		Transmission method	Base band
		Maximum segment length	100 m*3
		Number of cascade connections	100BASE-TX: 2 levels maximum*4 10BASE-T: 4 levels maximum*4
	Protocol type	Socket communication	
	Number of connections	Total of 32 connections*8	
	Hub*5	*9	
	Connection cable*7	100BASE-TX, 10BASE-T	
Number of ports	2*10		
Compatible CPU module	FX5U, FX5UC: Ver. 1.110 or later Connection with FX5UC requires FX5-CNV-IFC or FX5-C1PS-5V.		
Number of occupied I/O points	8 points (Either input or output is available for counting.)		
Number of connectable units	FX5U, FX5UC: Up to 1 module		
Power supply	24 V DC, 110 mA (internal power supply)		
External dimensions W × H × D (mm)	40×90×83		
MASS (Weight): kg	Approx. 0.2		

- *1 : The total number of connections for Class 3 communications and UCMM communications is 32.
 *2 : This size is the maximum size which can be specified to 'Data length' of Class1 communication input data area of the request command during the client operation. During the sever operation, since the FX5-ENET/IP automatically responds according to the request command received from the client, the maximum size is not prescribed.
 *3 : For maximum segment length (length between hubs), consult the manufacturer of the hub used.
 *4 : This number applies when a repeater hub is used. When using a switching hub, check the number of cascaded stages with the manufacturer of the hub to be used.
 *5 : IEEE802.3x flow control is not supported.
 *6 : Hubs with 100BASE-TX ports can be used. The ports must comply with the IEEE802.3 100BASE-TX standards.
 *7 : A straight/cross cable can be used.
 *8 : Up to 32 external devices can access one FX5-ENET/IP module at the same time.
 *9 : Hubs with 100BASE-TX or 10BASE-T ports can be used. The ports must comply with the IEEE802.3 100BASE-TX or IEEE802.3 10BASE-T standards.
 *10 : Since the IP address is shared by two ports, only one address can be set.

MODBUS

FX5 can be connected to various MODBUS communication devices as master station or slave station of the MODBUS communication.

MODBUS RTU communication

◇ Outline of Functions

- 1) Connection to 32 slave stations for RS-485 communication and one slave station for RS-232C communication is possible with a single master station.
- 2) Master function and slave functions are supported, and the master and slave can be used simultaneously by a single FX5. (However, only one channel can be used for the master station.)
- 3) Up to 4 channels can be used for MODBUS serial communication function by one CPU module.

◇ System configuration example

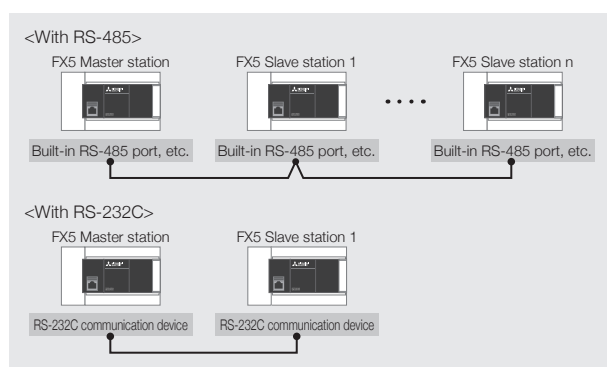

◇ Specifications

Item	Specifications	
	Built-in RS-485 port FX5-485-BD FX5-485ADP	FX5-232-BD FX5-232ADP
Number of connected modules	Up to 4 channels*1 (only 1 channel for the master)	
Communication Specifications	Communication interface	RS-485 / RS-232C
	Baud rate	300/600/1200/2400/4800/9600/19200/38400/57600/115200 bps
	Data length	8 bits
	Parity bit	None, odd or even
	Stop bit	1 bit/2 bits
	Transmission distance*2	1200 m or less when configured with FX5-485ADP only 50 m or less when configured other than the above
Communication protocol	RTU	
Master function	Number of connectable slaves*3	32 stations / 1 station
	Number of functions	8 (without diagnostic function)
	Number of simultaneous transmission messages	1 message
	Maximum number of writes	123 words or 1968 coils
Slave function	Maximum number of reads	125 words or 2000 coils
	Number of functions	8 (without diagnostic function)
	Number of messages that can be received simultaneously	1 message
	Station number	1 to 247

*1: Available by either master or slave.
 *2: The transmission distance varies depending on the type of communications equipment.
 *3: The number of slaves varies depending on the type of communications equipment.

MODBUS/TCP communication

◇ Features

- 1) Communication is possible, via Ethernet connection, with various MODBUS/TCP master devices connected to the FX5 set as the slave station.
- 2) Master function and slave functions are supported, and the master and slave can be used simultaneously by a single FX5.
- 3) Up to 8 connections can be used for MODBUS/TCP communication function by one CPU module.

◇ System configuration example

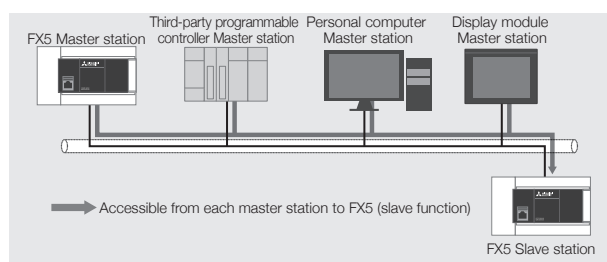

◇ Specifications

For communication specification other than the followings, refer to the MELSEC iQ-F FX5 User's Manual (Ethernet Communication).

Items	Specifications	
Supported protocol	MODBUS/TCP (Binary only supported)	
Number of connections	Total of 8 connections*1 (Up to 8 external devices can access one CPU module at the same time.)	
Slave function	Number of functions	10
	Port station No.	502*2

*1: The number of available connections decreases when the other Ethernet communication function is used. However, the first MELSOFT connection, CC-Link IE Field Network Basic, FTP server, SNMP client, and Web server are not included in the number of connections (The second and subsequent MELSOFT connections are included). For details on the Ethernet communication function, refer to the following manual.
 → MELSEC iQ-F FX5 User's Manual (Ethernet Communication)
 *2: The port station No. can be changed by the communication setting.

Sensor Solution

Sensor wire-saving system of AnyWireASLINK is easily configurable.

FX5-ASL-M type AnyWireASLINK system master module

◆ Features



- 1) The AnyWireASLINK system can centrally monitor the status of sensors from the PLC and perform disconnection/short-circuit detection, sensor sensitivity setting, status monitoring, etc. It has no restrictions about the minimum distance between terminals, and also provides free wiring methods such as T-branch, multidrop, star etc., allowing for flexible branching and connection.
- 2) Since the status of the sensor can be monitored from the PLC, it is possible to predict the occurrence of troubles such as a decrease in the amount of light received by the sensor and prevent the production line from stopping in advance.
- 3) ID (address) can be changed from the buffer memory for one slave module without using the address writer. A slave ID can be changed even from a remote location.*

*: For the slave modules compatible with the remote address change function, contact Anywire Corporation.

◆ Safety precautions

FX5-ASL-M is jointly developed and manufactured with Anywire Corporation. Note that the warranty for this product differs from the ones for other PLC products.

For details of warranty and specifications, refer to the manual.

◆ Specifications

Item	Specifications
Transmission clock	27.0 kHz
Maximum transmission distance (total extension distance)	200 m*1
Transmission system	DC power supply superimposed total frame/cyclic system
Connection type	Bus type (multi-drop method, T-branch method, tree branch method)
Transmission protocol	Dedicated protocol (AnyWireASLINK)
Error control	Checksum, double check method
Number of connected I/O points	Up to 448 points*2*3 (256 input points maximum/256 output points maximum)
Number of connected modules	Up to 128 modules (the number varies depending on the current consumption of each slave module)
Maximum number of I/O points per system	Number of slave module input points + number of slave module output points ≤ 384 points
External interface	7-piece spring clamp terminal block push-in type
RAS function	<ul style="list-style-type: none"> • Transmission line disconnection position detection function • Transmission line short-circuit detection function • Transmission power drop detection function
Transmission line (DP, DN)	UL compatible general-purpose 2-wire cable (VCTF, VCT 1.25 mm ² , 0.75 mm ² , temperature rating 70°C or higher) UL compatible general-purpose cable (1.25 mm ² , 0.75 mm ² , temperature rating 70°C or higher) Dedicated flat cable (1.25 mm ² , 0.75 mm ² , temperature rating 90°C)
Power cable (24 V, 0 V)	UL compatible general-purpose 2-wire cable (VCTF, VCT 0.75 to 2.0 mm ² , temperature rating 70°C or higher) UL compatible general-purpose power cable (0.75 to 2.0 mm ² , temperature rating 70°C or higher) Dedicated flat cable (1.25 mm ² , 0.75 mm ² , temperature rating 90°C)
Memory	Built-in EEPROM (Number of times of overwrite : 100000 times)
Compatible CPU module	FX5U, FX5UC: Ver. 1.050 or later Connection with FX5UC requires FX5-CNV-IFC or FX5-C1PS-5V.
Power supply	5 V DC, 200 mA (internal power supply) 24 V DC -10%, +15% 100 mA (external power supply)
Number of occupied I/O points	8 points (Either input or output is available for counting.)
Number of connectable modules	FX5U, FX5UC: Max. 1 module*4
External dimensions W x H x D (mm)	40 x 90 x 97.3
MASS (Weight): kg	Approx. 0.2

* 1: For the slave module in which the transmission line (DP, DN) and module body are integrated, the length of the transmission line (DP, DN) is also included in the total extension.
When laying a 4-wire (DP, DN, 24 V, 0 V) line for fifty meters or more, insert a power line noise filter between the power supply and the line.

For details, refer to the manual of ASLINK filter (ANF-01) made by Anywire Corporation.

* 2: The number of remote I/O points that can be used per system varies depending on the number of input/output points of the extension device.

For the limit of the number of I/O points, refer to the following manual.

→ MELSEC iQ-F FX5U User's Manual (Hardware)

→ MELSEC iQ-F FX5UC User's Manual (Hardware)

* 3: Supported by FX5U CPU modules Ver. 1.100 or later and by GX Works3 Ver. 1.047Z or later.

* 4: Use together with the FX3U-128ASL-M is not possible.

FX3U-128ASL-M type AnyWireASLINK System Master Module

◇ Characteristics



- 1) A master module enables MELSEC iQ-F series to be connected to the AnyWireASLINK sensor wire-saving system of Anywire Corporation.
- 2) FX3U-128ASL-M type AnyWireASLINK system master module has a proprietary AnyWire transmission system including a power supply (equivalent to 24 V DC, MAX. 2 A) as a transmission signal, and thus realizes save wiring up to 200 m with a 4-core or 2-core cable.
- 3) When using ASLINKAMP or ASLINKSENSOR, settings can be changed by a ladder program, engineering tool or GOT. Set-up changes can be done remotely.

◇ Safety Precautions

FX3U-128ASL-M is jointly developed/ manufactured with Anywire Corporation. Guarantee details are different from other PLC products. Refer to manuals for guarantees/ specifications.

◇ Specifications

Items	Specifications
Transmission clock	27.0 kHz
Max. transmission distance (total extension length)	200 m
Transmission method	DC power supply superimposing total frame/cyclic method
Connection configuration	Bus type (Multi-drop method, T-branch method, tree branch method)
Transmission protocol	Dedicated protocol (AnyWireASLINK)
Error control	Double verification method, checksum
No. of connection I/O points	Max. 128 points
No. of connection modules	Max. 128 modules (variable depending on current consumption)
Max. no of I/O points per system	No. of input points of slave module + No. of output points of slave module ≤ 128 points
RAS function	<ul style="list-style-type: none"> • Transmission line disconnection position detection function • Transmission line short-circuit detection function • Transmission power drop detection function
AnyWireASLINK transmission line	UL supported general-use 2-line cable (VCTF, VCT 1.25 mm ² , 0.75 mm ² , rated temperature: 70°C or higher) UL supported general-use electric wire (1.25 mm ² , 0.75 mm ² , rated temperature: 70°C or higher), dedicated flat cable (1.25 mm ² , 0.75 mm ² , rated temperature: 90°C)
24 V DC power supply line	UL supported general-use 2-line cable (VCTF, VCT 0.75 to 2.0 mm ² , rated temperature: 70°C or higher) UL supported general-use electric wire (0.75 to 2.0 mm ² , rated temperature: 70°C or higher), dedicated flat cable (1.25 mm ² , 0.75 mm ² , rated temperature: 90°C)
Compatible CPU module	Supported from the first product of FX5U or FX5UC Connection with FX5U or FX5UC requires FX5-CNV-BUS or FX5-CNV-BUSC.
Power supply	5 V DC, 130 mA (internal power supply) 24 V DC -10% + 15% 100 mA (AnyWireASLINK communication external power supply)
No. of occupied I/O points	8 points (countable either by input or output)
Communication with PLC	Done by FROM/TO instruction via buffer memory (buffer memory can be directly specified)
No. of connectable modules	FX5U, FX5UC: Max. 1 module*
External dimensions W x H x D (mm)	43 x 90 x 95.5
MASS (Weight): kg	Approx. 0.2

*: Use together with the FX5-ASL-M is not possible.

Your requests for reduced wiring, detecting of disconnection/short circuit, setting of sensor sensitivity, and status monitoring can be satisfied by MELSEC iQ-F.

Powered by **Anywire**

▶ Example of system configuration (AnyWireASLINK)

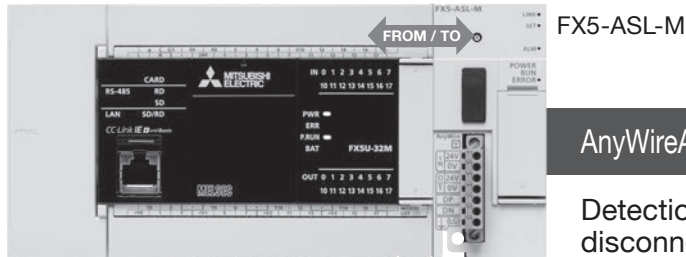

AnyWireASLINK sensor can be connected.

Detection of short circuit and disconnection, setting of sensor sensitivity, address automatic recognition

Total extension length of 200 m*1*2, Max. 448 points*3*4 and Max. 128 modules*2 connectable

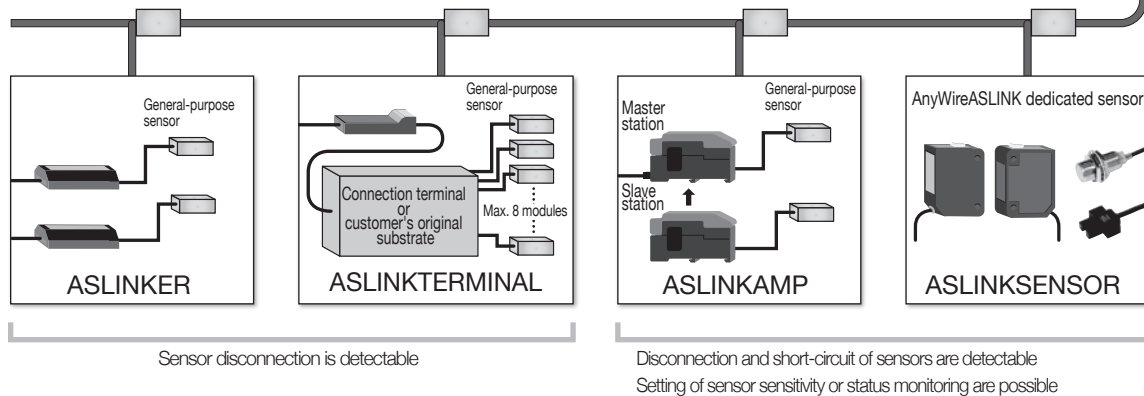

AnyWireASLINK

Max. no. of I/O: 2 points

■ ASLINKER

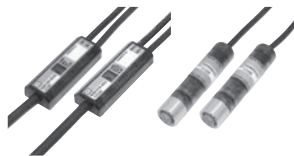

Cable lamp

Connector type

Max. no. of I/O: 8 points

■ ASLINKTERMINAL



8-point input terminal

8-point output terminal

General-purpose sensor head connection

■ ASLINKAMP



Max. 16 modules can be added.

Directly connected sensors

■ ASLINKSENSOR



Optical sensor

Proximity sensor

Photo interrupter

*1: Total extension distance including the portion of branch line.

*2: Subject to change based upon current consumption of each slave module.

*3: The number of remote I/O points that can be used per system varies depending on the number of input/output points of the extension device. For the limit of the number of I/O points, refer to the following manual.

→ MELSEC iQ-F FX5U User's Manual (Hardware)

→ MELSEC iQ-F FX5UC User's Manual (Hardware)

*4: Supported by FX5U CPU modules Ver. 1.100 or later and by GX Works3 Ver. 1.047Z or later.

PROFIBUS-DP

PROFIBUS is an industrial fieldbus developed and maintained by PROFIBUS & PROFINET International (PI). This protocol enables high-speed data transmission between field devices such as a remote I/O module or drive and a controller.

FX5-DP-M type PROFIBUS-DP master station module

◆ Features



- 1) This master module is necessary for using the MELSEC iQ-F Series as a PROFIBUS-DP master station. Using this product makes it possible to incorporate compatible slave devices into the system.
- 2) Using the buffer memory makes it possible to obtain communications error information or extended communications error information generated by a slave station during I/O data transmission.
- 3) Settings can be configured with the following software:
 - GX Works3 (Ver. 1.050C or later)
 - PROFIBUS Configuration Tool (Ver. 1.02C or later)

◆ Specifications

Items	Specifications
PROFIBUS-DP station type	Class 1 master station
Electrical standard and characteristics	Compliant with EIA-RS485
Medium	Shielded twisted pair cable
Network configuration	Bus topology (or tree topology when repeaters are used)
Data link method	Between DP-Masters: Token passing Between DP-Master and DP-Slave: Polling
Encoding method	NRZ
Transmission speed*	9.6 kbps, 19.2 kbps, 93.75 kbps, 187.5 kbps, 500 kbps, 1.5 Mbps, 3 Mbps, 6 Mbps, 12 Mbps
Transmission distance	Differs depending on transmission speed
Maximum number of repeaters (Between DP-Master and DP-Slave)	3 repeaters
Number of connectable modules (per segment)	32 per segment (including repeaters)
Maximum number of DP-Slaves	64 modules
Number of connectable nodes (number of repeaters)	32, 62 (1), 92 (2), 122 (3), 126 (4)
Transmittable data	Input data
	Output data
Compatible CPU module	Max. of 2048 bytes (Max. of 244 bytes per DP-Slave) Max. of 2048 bytes (Max. of 244 bytes per DP-Slave) FX5U, FX5UC: Ver. 1.110 or later Connection with FX5UC requires FX5-CNV-IFC or FX5-C1PS-5V.
Number of occupied I/O points	8 points (Either input or output is available for counting.)
Number of connectable modules	FX5U, FX5UC: Up to 1 module
Power supply	24 V DC, 150 mA (internal power supply)
External dimensions W x H x D (mm)	40 x 90 x 85.3
MASS (Weight): kg	Approx. 0.2

*: Transmission speed accuracy is within ±0.2% (compliant with IEC61158-2).

FX3U-32DP type PROFIBUS-DP slave station module

◆ Features



- 1) Connectable as a MELSEC iQ-F Series slave station in PROFIBUS-DP systems.

◆ Specifications

Items	Specifications
PROFIBUS-DP station type	PROFIBUS-DP slave station
Transmission speed	9.6 kbps, 19.2 kbps, 45.45 kbps, 93.75 kbps, 187.5 kbps, 500 kbps, 1.5 Mbps, 3 Mbps, 6 Mbps, 12 Mbps
Transmission distance/segment	Transmission speed
	No repeaters
	1 repeater
	2 repeaters
Transmittable data	Up to 144 bytes Default: 32 bytes (cyclic input / cyclic output)
	PROFIBUS module ID
	Global control
	Compatible CPU module
Number of occupied I/O points	8 points (Either input or output is available for counting.)
Number of connectable modules	FX5U: Up to 8 modules*, FX5UC: Up to 6 modules
Power supply	24 V DC, 145 mA (internal power supply)
External dimensions W x H x D (mm)	43 x 90 x 89
MASS (Weight): kg	Approx. 0.2

*: When using FX3U-1PSU-5V. Up to 6 modules when not using FX3U-1PSU-5V.

General-purpose Communication Devices

Various communication functions can be added easily using an expansion board or expansion adapter. Communications with data link or external serial interface device can be realized easily by adding an expansion board.

Expansion board (for communication)

◆ Features

- 1) Communication expansion board can be added to FX5U CPU module.
- 2) Communication function can be added inexpensively.

Refer to the following items for usage method of expansion board.

- "N:N network"
- "Parallel link"
- "MC protocol"
- "Non-protocol communication"
- "Connection to peripheral device"
- "Inverter communication function"

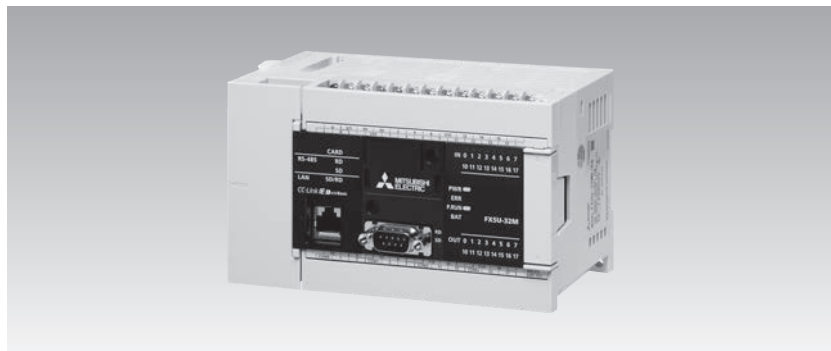

◆ Specifications

Model/Characteristics	Items	Specifications
FX5-232-BD RS-232C communication expansion board 	Transmission standard	Conforming to RS-232C standard
	Max. transmission distance	15 m
	External device connection method	9-pin D-sub (male)
	Isolation	No isolation (between communication line and CPU)
	Communication method	Half-duplex bidirectional/Full-duplex bidirectional*
	Protocol type	MELSOFT connection, MC protocol (1C/3C/4C frame), non-protocol communication, MODBUS RTU communication, predefined protocol support
	Communication speed	300/600/1200/2400/4800/9600/19200/38400/57600/115200 (bps)*
	Terminal resistors	—
	Power supply	5 V DC, 20 mA (internal power supply)
	Compatible CPU module	FX5U CPU module
	No. of occupied I/O points	0 points (No occupied points)
	External dimensions W × H × D (mm)	38 × 51.4 × 18.2
	MASS (Weight): kg	Approx. 0.02

*: The communication method and communication speed vary depending upon the communication type.

Model/Characteristics	Items	Specifications
FX5-485-BD RS-485 communication expansion board 	Transmission standard	Conforming to RS-485 and RS-422 standards
	Max. transmission distance	50 m
	External device connection method	European-type terminal block
	Isolation	No isolation (between communication line and CPU)
	Communication method	Half-duplex bidirectional/Full-duplex bidirectional*
	Protocol type	MELSOFT connection, MC protocol (1C/3C/4C frame), non-protocol communication, MODBUS RTU communication, inverter communication, N:N network, parallel link, predefined protocol support
	Communication speed	300/600/1200/2400/4800/9600/19200/38400/57600/115200 (bps)*
	Terminal resistors	Built in (OPEN/110 Ω/330 Ω)
	Power supply	5 V DC, 20 mA (internal power supply)
	Compatible CPU module	FX5U CPU module
	No. of occupied I/O points	0 points (No occupied points)
	External dimensions W × H × D (mm)	38 × 51.4 × 30.5
	MASS (Weight): kg	Approx. 0.02

*: The communication method and communication speed vary depending upon the communication type.

Model/Characteristics	Items	Specifications
FX5-422-BD-GOT RS-422 communication expansion board (GOT connection) 	Transmission standard	Conforming to RS-422 standard
	Max. transmission distance	As per GOT specifications
	External device connection method	8-pin MINI-DIN (female)
	Isolation	No isolation (between communication line and CPU)
	Communication method	Half-duplex bidirectional
	Communication speed	9600/19200/38400/57600/115200 (bps)
	Terminal resistors	—
	Power supply	5 V DC, 20 mA (internal power supply)*
	Compatible CPU module	FX5U CPU module
	No. of occupied I/O points	0 points (No occupied points)
	External dimensions W × H × D (mm)	38 × 51.4 × 15.4
	MASS (Weight): kg	Approx. 0.02

*: When the GOT 5V type is connected with this product, the power consumption increases. For the current consumption, refer to the manual of the model to be connected.

FX5-232ADP type RS-232C communication expansion adapter

◆ Features



Isolation type RS-232C communication adapter
 Refer to the "MC protocol", "Non-protocol communication", "Connection to peripheral device" for more details of functions.

◆ Specifications

Items	Specifications
Transmission standard	Conforming to RS-232C standard
Max. transmission distance	15 m
Isolation	Photocoupler isolation (between communication line and CPU)
External device connection method: connector	9-pin D-sub (male)
Communication method	Half-duplex bidirectional/Full-duplex bidirectional
Protocol type	MELSOFT connection, MC protocol (1C/3C/4C frame), non-protocol communication, MODBUS RTU communication, predefined protocol support
Communication speed	300/600/1200/2400/4800/9600/19200/38400/57600/115200 (bps)*
No. of occupied I/O points	0 points (No occupied points)
Current consumption (internal supply)	5 V DC 30 mA/24 V DC 30 mA
Compatible CPU module	Compatible with FX5U and FX5UC, from their first released products
Number of connectable modules	FX5U, FX5UC: Up to two communication adapters are provided on the left side of the CPU module.
External dimensions W × H × D (mm)	17.6 × 106 × 82.8
MASS (Weight): kg	Approx. 0.08

*: The communication method and communication speed vary depending upon the communication type.

FX5-485ADP type RS-485 communication expansion adapter

◆ Features

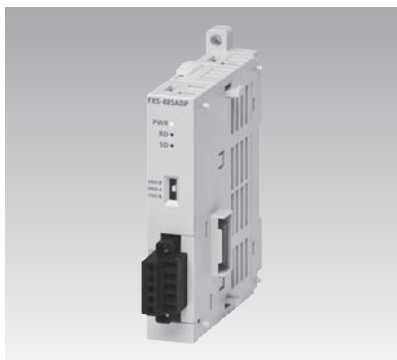

Isolation type RS-485 communication adapter
 Refer to the "N:N network", "Parallel link", "MC Protocol", "Non-protocol communication", "Connection to peripheral device", "Inverter communication function" for more details of functions.

◆ Specifications

Items	Specifications
Transmission standard	Conforming to RS-485 and RS-422 standards
Max. transmission distance	1200 m
Isolation	Photocoupler isolation (between communication line and CPU)
External device connection method	European-type terminal block
Communication method	Half-duplex bidirectional/Full-duplex bidirectional
Protocol type	MELSOFT connection, MC protocol (1C/3C/4C frame), non-protocol communication, MODBUS RTU communication, inverter communication, N:N network, parallel link, predefined protocol support
Communication speed	300/600/1200/2400/4800/9600/19200/38400/57600/115200 (bps)*
Terminal resistors	Built in (OPEN/110 Ω/330 Ω)
No. of occupied I/O points	0 points (No occupied points)
Current consumption (internal supply)	5 V DC 20 mA/24 V DC 30 mA
Compatible CPU module	Compatible with FX5U and FX5UC, from their first released products
Number of connectable modules	FX5U, FX5UC: Up to two communication adapters are provided on the left side of the CPU module.
External dimensions W × H × D (mm)	17.6 × 106 × 89.1
MASS (Weight): kg	Approx. 0.08

*: The communication method and communication speed vary depending upon the communication type.

N:N Network

Using the built-in RS-485 port, RS-485 communication expansion board, or expansion adapter enables data link of 2 to 8 PLCs easily.

RS-485 communication device

Model	Types	Compatible CPU module	
		FX5U	FX5UC
FX5-485-BD	Expansion board	○	×
FX5-485ADP	Expansion adapter	○	○
—	Built-in RS-485 port	○	○

N:N network function

◆ Features

- 1) Data link can be realized by a simple program for connecting up to 8 modules of FX5 or FX3.
- 2) The bit device (0 to 64 points) and word device (4 to 8 points) are automatically linked between each station. The ON/OFF state of other stations and data register values can be obtained by the device allocated on the local station.

◆ System configuration example

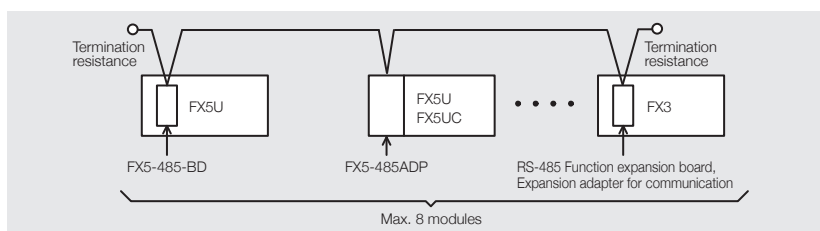

◆ Specifications of N:N network function

Items		Specifications
Transmission standard		Conforming to RS-485 standard
Total extension length		Configuration only using FX5-485ADP: 1200 m or less Configuration using FX5-485ADP, FX3U-485ADP(-MB): 500 m or less Configuration other than above: 50 m or less (at coexisting of built-in RS-485 port, FX5-485-BD and 485-BD for FX3: 50 m or less)
Communication method/Transmission speed		Half-duplex bidirectional, 38400 bps
No. of connectable modules		Max. 8 modules
No. of link points	Pattern 0	Bit device: 0 points Word device: 4 points
	Pattern 1	Bit device: 32 points Word device: 4 points
	Pattern 2	Bit device: 64 points Word device: 8 points
Link refresh time (ms)	Pattern 0	Based on the no. of connection modules, 2 modules (20), 3 modules (29), 4 modules (37), 5 modules (46), 6 modules (54), 7 modules (63), 8 modules (72)
	Pattern 1	Based on the no. of connection modules, 2 modules (24), 3 modules (35), 4 modules (45), 5 modules (56), 6 modules (67), 7 modules (78), 8 modules (88)
	Pattern 2	Based on the no. of connection modules, 2 modules (37), 3 modules (52), 4 modules (70), 5 modules (87), 6 modules (105), 7 modules (122), 8 modules (139)
Connection device with PLC	FX5U	FX5-485ADP, FX5-485-BD
	FX5UC	FX5-485ADP
	FX3S	FX3G-485-BD(-RJ) or FX3S-CNV-ADP+FX3U-485ADP(-MB)
	FX3G	FX3G-485-BD(-RJ) or FX3G-CNV-ADP+FX3U-485ADP(-MB)
	FX3GC	FX3U-485ADP(-MB)
FX3U, FX3UC*	FX3U-485-BD or Function expansion board+FX3U-485ADP(-MB)	
Compatible CPU module		FX5U, FX5UC, FX3S, FX3G, FX3GC, FX3U, FX3UC

*: Function expansion board cannot be connected to FX3UC-□□MT/D, FX3UC-□□MT/DSS, and FX3UC-16MR/D□-T. A special adapter can be connected directly.

Parallel link

2 modules of FX5U/FX5UC can be connected using the built-in RS-485 port, RS-485 communication expansion board, and expansion adapter, and devices can be linked to each other.

RS-485 communication equipment

Model name	Classification	Compatible CPU module	
		FX5U	FX5UC
FX5-485-BD	Expansion board	○	×
FX5-485ADP	Expansion adapter	○	○
—	Built-in RS-485 port	○	○

Parallel link function

◆ Features

- 1) With 2 modules of FX5U/FX5UC connected, devices can be linked to each other only by parameter setting.
- 2) 2 types of link modes, normal parallel link mode and high-speed parallel link mode, can be selected according to the number of points you want to link to and the link time, and the data link is automatically updated between the 2 modules of FX5U/FX5UC.

◆ System configuration example

Parallel link

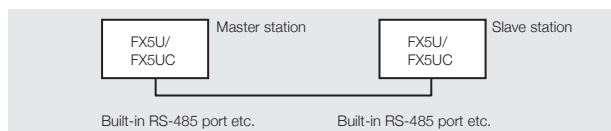

◆ Parallel link specifications

Item	Specifications
Number of connected modules	Up to 2 modules (1:1)
Transmission standards	RS-485 standard compliant
Maximum overall cable distance	1200 m or less when configured with FX5-485ADP only 50 m or less when configured other than the above
Link time	Normal parallel link mode: 15 ms + master station operation cycle (ms) + slave station operation cycle (ms) High-speed parallel link mode: 5 ms + master station operation cycle (ms) + slave station operation cycle (ms)

MC Protocol

Data link of multiple PLCs can be realized by setting a CPU module or external device as a master station using MC protocol (serial communication).

Since data link is done by command from the external device, it is suitable for configuration of data management and control system by the external device as the main controller.

RS-232C, RS-485 communication device

Model	Types	Compatible CPU module	
		FX5U	FX5UC
FX5-232-BD	Expansion board	○	×
FX5-232ADP	Expansion adapter	○	○
FX5-485-BD	Expansion board	○	×
FX5-485ADP	Expansion adapter	○	○
—	Built-in RS-485 port	○	○

MC protocol function

◇ Features

- Using the RS-485 communication device enables connection of up to 16 modules of FX5U/FX5UC, and data can be transferred according to commands from the PC.
- Using the RS-232C communication device enables 1 : 1 data transfer with the PC.
- Communication by MC protocol A-compatible 1C frame and QnA-compatible-3C/4C frame is possible. (Type 1/Type 4/Type 5)

◇ System configuration example

- 1 : n connection using RS-485 communication

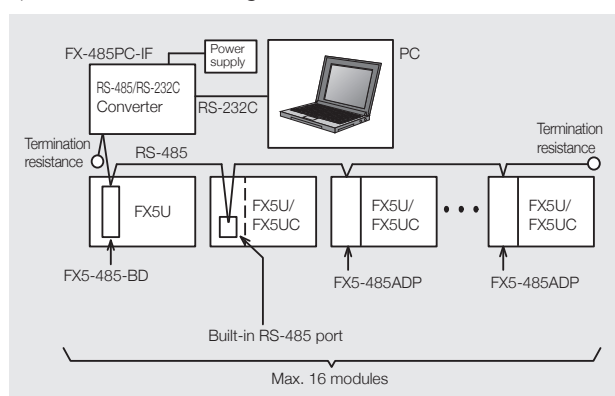

- 1 : 1 connection using RS-232C communication

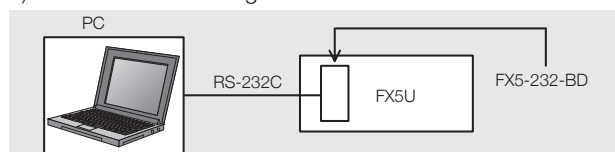

◇ MC protocol function specifications



Items		Specifications
Transmission standard		Conforming to RS-485/RS-232C standard
Total extension length	RS-485	When using FX5-485ADP: 1200 m or less When using the built-in RS-485 port or FX5-485-BD: 50 m or less
	RS-232C	15 m or less
Communication method		Half-duplex bidirectional
Transmission speed		300/600/1200/2400/4800/9600/19200/38400/57600/115200 bps
No. of connectable modules		Max. 16 modules
Protocol types		MC protocol (dedicated protocol) 1C/3C Frame (Type1/Type4) / 4C Frame (Type1/Type4/Type5)
RS-485 connection device	FX5U	Built-in RS-485 port, FX5-485-BD or FX5-485ADP
	FX5UC	Built-in RS-485 port or FX5-485ADP
RS-232C connection device	FX5U	FX5-232-BD or FX5-232ADP
	FX5UC	FX5-232ADP
Compatible CPU module		FX5U, FX5UC

RS-232C/RS-485 Non-protocol communication

MELSEC iQ-F Series modules can communicate with printers, code readers, measurement instruments, etc. having an interface in accordance with RS-232C/RS-485 (RS-422). Communication is performed using sequence programs (RS2 instruction).

RS-232C communication

◇ RS-232C communication device

Model (No. of channels)	Communication method	Isolation	Maximum transmission distance	Control instruction	Compatible CPU module	
					FX5U	FX5UC
FX5-232-BD (1 ch) 	Half-duplex bidirectional/ Full-duplex bidirectional	No isolation (between communication line and CPU)	15 m	RS2 instruction	○ (Max. 1 module)	×
FX5-232ADP (1 ch) 	Half-duplex bidirectional/ Full-duplex bidirectional	Photocoupler isolation (between communication line and CPU)	15 m	RS2 instruction	○ (Max. 2 modules)	○ (Max. 2 modules)

◇ Communication specification

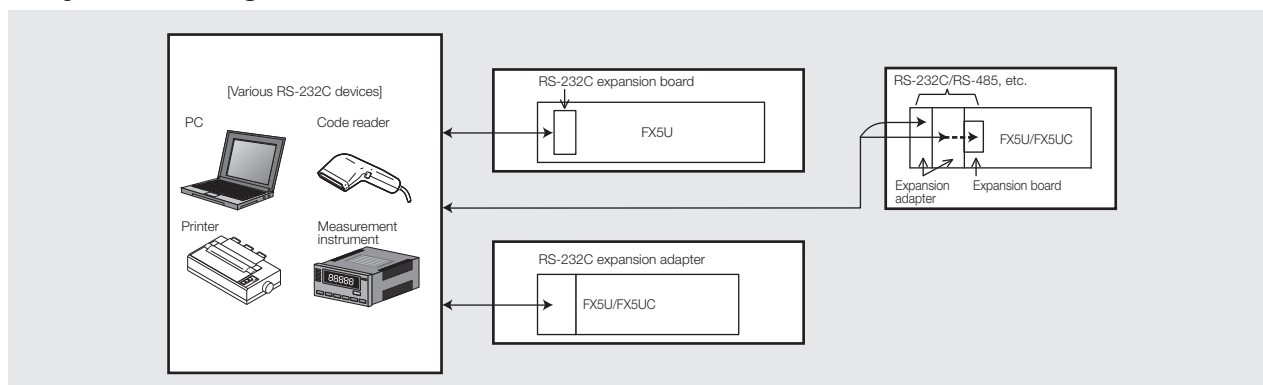

Refer to the specifications of each communication device for the details of RS-232C device specifications.

◇ System configuration



RS-485 (RS-422) communication

◇ RS-485 (RS-422) communication device

Model (No. of channels)	Communication method	Isolation	Maximum transmission distance	Control instruction	Compatible CPU module	
					FX5U	FX5UC
FX5-485-BD (1 ch) 	Half-duplex bidirectional/ Full-duplex bidirectional	No isolation (between communication line and CPU)	50 m	RS2 instruction	○ (Max. 1 module)	×
FX5-485ADP (1 ch) 	Half-duplex bidirectional/ Full-duplex bidirectional	Photocoupler isolation (between communication line and CPU)	1200 m	RS2 instruction	○ (Max. 2 modules)	○ (Max. 2 modules)
Built-in RS-485 port (1 ch) 	Half-duplex bidirectional/ Full-duplex bidirectional	No isolation (between communication line and CPU)	50 m	RS2 instruction	○	○

◇ Communication specification

Refer to the specifications of each communication device for the details of RS-485 device specifications.

◇ System configuration example

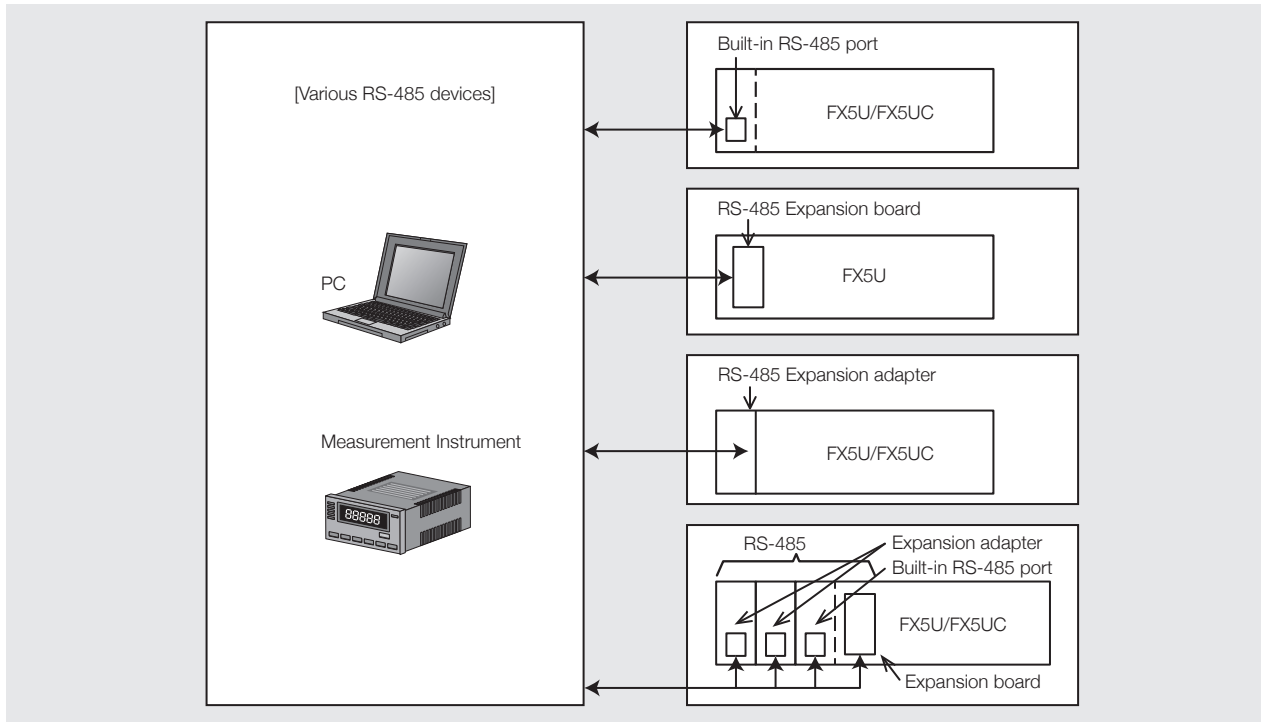



Connection to Peripheral Devices

Installing RS-422/RS-232C communication devices enables addition of connection ports with peripheral devices. PLC programming devices such as PC and HMI (GOT) can be connected to the added ports.

RS-232C communication

◇ RS-232C communication device

Model (No. of channels)	Communication method	Isolation	Maximum transmission distance	Compatible CPU module	
				FX5U	FX5UC
FX5-232-BD (1 ch) 	Half-duplex bidirectional/ Full-duplex bidirectional	No isolation (between communication line and CPU)	15 m	○ (Max. 1 module)	×
FX5-232ADP (1 ch) 	Half-duplex bidirectional/ Full-duplex bidirectional	Photocoupler isolation (between communication line and CPU)	15 m	○ (Max. 2 modules)	○ (Max. 2 modules)

◇ Communication specification

Refer to the specifications of each communication device for the detailed specifications of RS-232C peripheral devices (programming protocol).

◇ Connection cable for RS-232C communication device and peripheral devices

The main connection cables are as follows:

Connection destination	Cable
DOS/V PC (9-pin D-SUB)	FX-232CAB-1
HMI (GOT)	Use the specific cable or wire for RS-232C connection of each HMI.

◇ Concurrent use of peripheral device

Connect an engineering tool such as PC software to either one of peripheral devices to avoid programs from being changed by multiple peripheral devices.

RS-422 (GOT) communication

◇ RS-422 communication device

Model (No. of channels)	Communication method	Isolation	Maximum transmission distance	Compatible CPU module	
				FX5U	FX5UC
FX5-422-BD-GOT (1 ch) 	Half-duplex bidirectional	No isolation (between communication line and CPU)	As per GOT specifications	○ (Max. 1 module)	×

◇ Communication specification

Refer to the manual of GOT.

◇ Communication cable



Use a dedicated cable for GOT.

Inverter Communication Function

Dedicated instructions for Mitsubishi Electric inverter protocol and communication control are built in FX5. Connecting an inverter enables simple control of inverter.

RS-485 communication

◇ RS-485 communication device

Model (No. of channels)	Communication method	Isolation	Maximum transmission distance	Control instruction	Compatible CPU module	
					FX5U	FX5UC
FX5-485-BD (1 ch) 	Half-duplex bidirectional/ Full-duplex bidirectional*	No isolation (between communication line and CPU)	50 m	Inverter instruction	○ (Max. 1 module)	×
FX5-485ADP (1 ch) 	Half-duplex bidirectional/ Full-duplex bidirectional*	Photocoupler isolation (between communication line and CPU)	1200 m	Inverter instruction	○ (Max. 2 modules)	○ (Max. 2 modules)
Built-in RS-485 port (1 ch) 	Half-duplex bidirectional/ Full-duplex bidirectional*	No isolation (between communication line and CPU)	50 m	Inverter instruction	○	○

*: Half-duplex bidirection in case of connecting to inverter.

◇ System configuration example

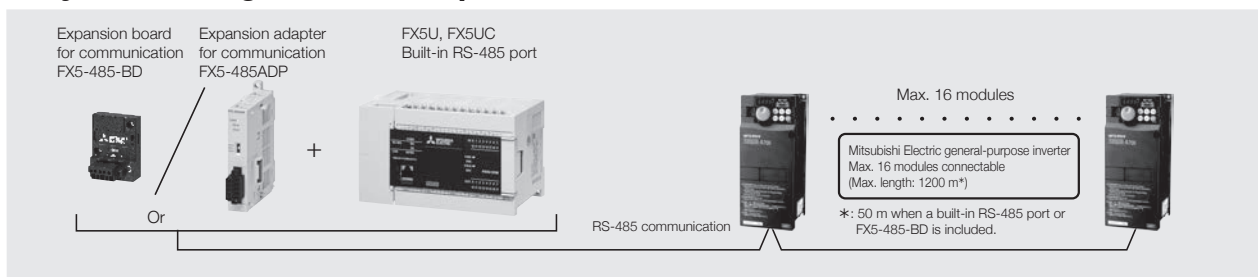

● Connectable Mitsubishi Electric general-purpose inverter



Inverter

[Connectable Models]
FR-A800/F800/F700P/J/E700/E700EX (sensorless servo) /D700

Inverter Communication Function

memo

Engineering Tool

Various types of engineering software are prepared to enable easy programming for the Mitsubishi Electric PLC and realize comfortable operation.

MELSOFT iQ Works FA Integrated Engineering Software

- **iQ Works (English version)** **Model: SW2DND-IQWK-E**

◇ Features

- By realization of a seamless integrated engineering environment, the total cost will be reduced.
- All the system labels can be checked on MELSOFT Navigator.
- Parameter settings for each project (GX Works3, GX Works2, MT Works2, and GT Works3) can be configured from MELSOFT Navigator.
This eliminates the need to launch various tools when configuring the parameter settings.
- System configuration can be managed graphically. Allows the user to manage the system configuration graphically, and the effort to search for an appropriate tool can be eliminated by linking the project.
- Double click the project from the system configuration figure and work space tree of MELSOFT Navigator to start the software for the device automatically.
- The data on whole system can be backed up in a batch by simple operation.

By realization of a seamless integrated engineering environment, the total cost will be reduced!

Sold as a set integrating various engineering software centered around MELSOFT Navigator, MELSOFT iQ Works eliminates the need to purchase software separately. The ability to share design information including system design and programming throughout the control system makes it possible to improve efficiency of system design and programming while reducing total costs.

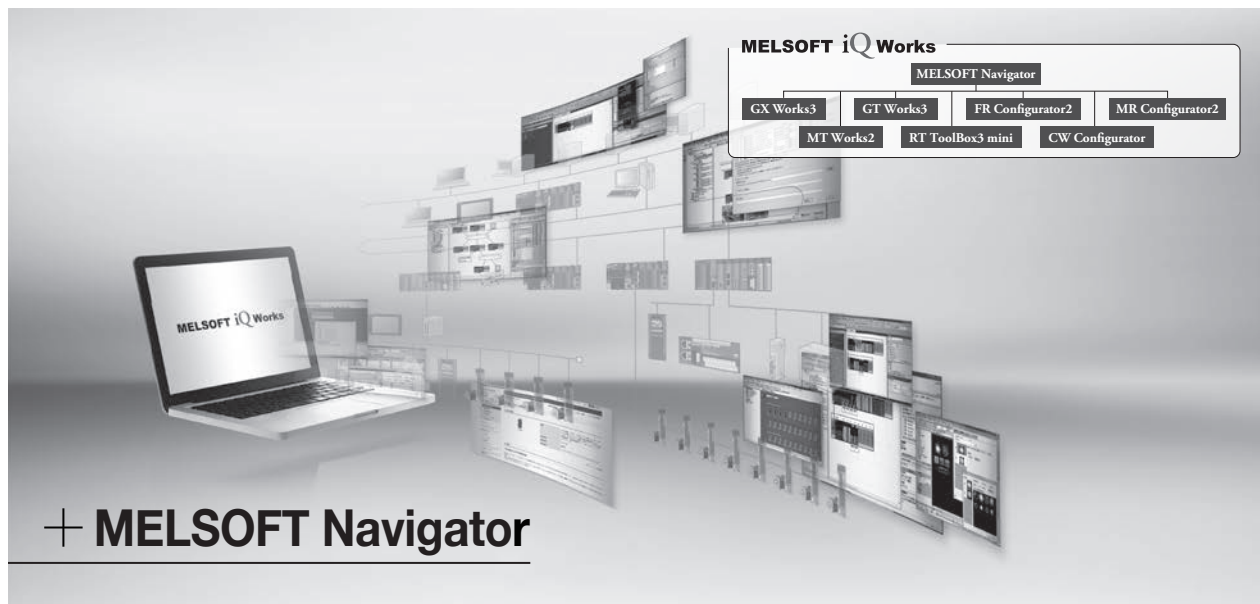

For details on MELSOFT iQ Works, refer to the following catalog:

"MELSOFT iQ Works catalog"
L(NA)08232ENG



MELSOFT GX Works3 PLC Engineering Software

● **GX Works3** **Model: SW1DND-GXW3-E**

◇ Features

- Achieving an easy and intuitive programming by only making "selections" in a graphical environment with module configuration diagram and module label/module FB.
- Supporting various applications (parameter settings of simple motion module, creation of positioning data, parameter setting and servo adjustments of servo amplifier).
- Complying with the international standard IEC 61131-3 for engineering software and supporting the modularized and structured programming. Programming languages such as ladder, ST, FBD/LD are available.
- Enabling transmitting/receiving of the data between an external device and the CPU module by matching the protocol of the external device. (Communication protocol support function)

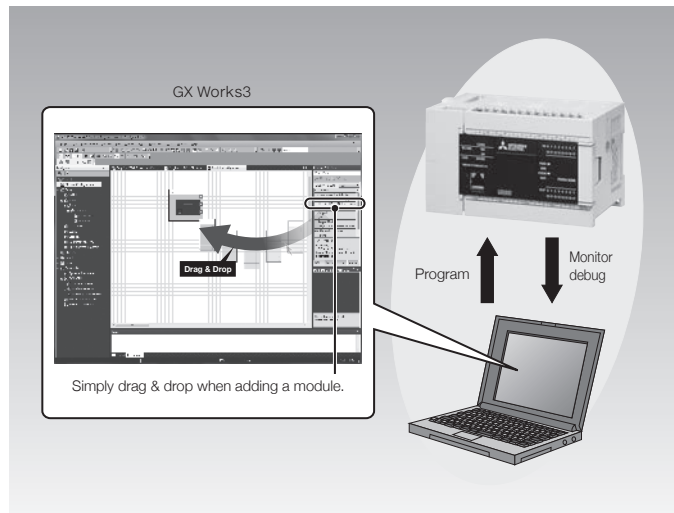

For details on MELSOFT GX Works3, refer to the following catalog available on request

"MELSOFT GX Works3 catalog"
L(NA)08334ENG



MELSOFT MX series Integrated Data Link Software

● **MX Component (Communication ActiveX Library)** **Model: SW4DNC-ACT-E**
 ● **MX Sheet (Microsoft® Excel® Communication Support Tool)** **Model: SW2DNC-SHEET-E**
 ● **MX Works (a set product of MX Component and MX Sheet)** **Model: SW2DNC-SHEETSET-E**

◇ Features

- A group of middleware remarkably improving development efficiency in the system configuration.
- Familiar Microsoft® Excel® settings on the screen enables easy data access of the on-site PLC without any program.
- Enabling the system to be configurable without considering a communication protocol.
- Enabling monitoring of on-site system only by setting parameters on the screen.

Operating environment

Engineering tool operating environment.
For details, refer to catalogs and manuals.

MELSOFT iQ Works and GX Works3 operating environment

Items		Contents		
PC Module	OS*1 English Version	Microsoft® Windows® 10 Home Microsoft® Windows® 10 Pro Microsoft® Windows® 10 Enterprise Microsoft® Windows® 10 Education Microsoft® Windows® 10 IoT Enterprise 2016 LTSC Microsoft® Windows® 8.1 Microsoft® Windows® 8.1 Pro Microsoft® Windows® 8.1 Enterprise Microsoft® Windows® 8	Microsoft® Windows® 8 Pro Microsoft® Windows® 8 Enterprise Microsoft® Windows® 7 Starter Microsoft® Windows® 7 Home Basic*3 Microsoft® Windows® 7 Home Premium Microsoft® Windows® 7 Professional Microsoft® Windows® 7 Ultimate Microsoft® Windows® 7 Enterprise Microsoft® Windows Vista® Home Basic	Microsoft® Windows Vista® Home Premium Microsoft® Windows Vista® Ultimate Microsoft® Windows Vista® Business Microsoft® Windows Vista® Enterprise Microsoft® Windows® XP Professional SP3 Microsoft® Windows® XP Home SP3
	CPU	Intel® Core™2 Duo 2 GHz or more recommended		
	Memory Requirements	1 GB or more recommended*2		
Hard Disc Free Space	[Installation] 26 GB or more*4 free disk space, [Operation] 512 MB or more free virtual memory			
Disc Drive	DVD-ROM supported disc drive			
Display	Resolution 1024 x 768 pixels or more			
Connection to PLC	Optional connection cable and interface are necessary. [PC Communication Port] Connectable from Ethernet port or RS-232C port. FX5U PLC : Directly connectable by Ethernet, or connectable by RS-232C communication expansion adapter or RS-232C communication expansion board. FX5UC PLC : Directly connectable by Ethernet or connectable by RS-232C communication expansion adapter. Refer to the "PC and PLC Connection Method" for the details of connection method and required cable types.			
Compatible CPU module	FX5U, FX5UC (Refer to the specific catalog or manual for details on FX Series, L Series, Q Series, and iQ-R Series modules.)			

*1: 64-bit versions of Windows Vista® and Windows® XP are not supported. 32-bit version of Microsoft® Windows® 10 IoT Enterprise 2016 LTSC is not supported.
*2: 2 GB or more recommended for 64-bit version
*3: iQ Works is not supported.
*4: 17 GB or more for installing only GX Works3

PC and PLC Connection Method and Required Equipment

◇ In case of connection between Ethernet port on the PC side

Connecting to the Ethernet port

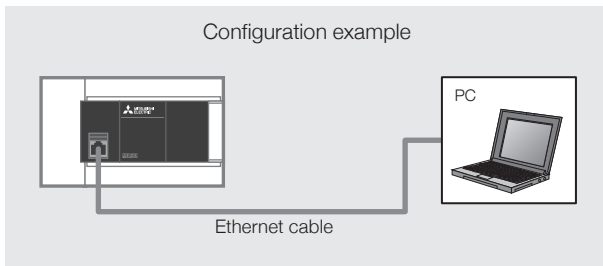

◇ In case of connection between RS-232C port on the PC side

(1) Connection with the RS-232C port attached to PLC (using FX5-232ADP)

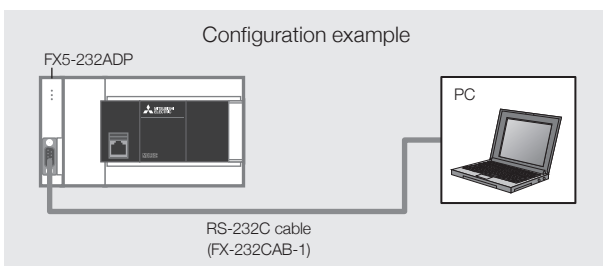

(2) Connection with the RS-232C port attached to PLC (using FX5-232-BD)

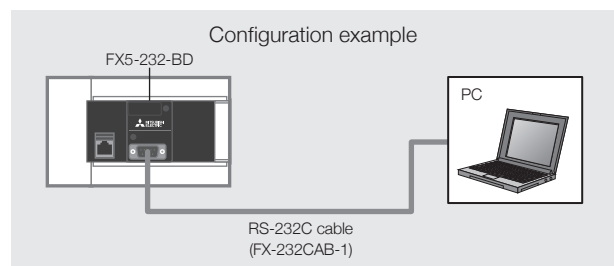

Compatible Versions of Software

The followings are compatible versions of each software.

New versions may be required due to addition of functions and products. Please refer to the manuals for more details.

Category	Type	Compatible version		
		FX5U	FX5UC	Precautions
Software for PLC	iQ Works	Ver. 2.07H or above	Ver. 2.07H or above	Use the latest version when new functions are added.
	GX Works3	Ver. 1.007H or above	Ver. 1.007H or above	
Software for GOT (GOT1000 series, GOT2000 series)	GT Works3	Ver. 1.126G or above	Ver. 1.126G or above	Compatible to the device scope. Refer to the GOT manual for other compatible items.

Option/Related Products

We are pleased to offer you a wide variety of our products including SD memory cards, batteries, connection cables for PLC as well as interfaces for signal exchange.

SD Memory Card



Model/Appearance	Contents		
NZ1MEM-2GBSD NZ1MEM-4GBSD NZ1MEM-8GBSD NZ1MEM-16GBSD 	NZ1MEM-2GBSD	Type	SD memory card
		Capacity	2 GB
	NZ1MEM-4GBSD	Type	SDHC memory card
		Capacity	4 GB
	NZ1MEM-8GBSD	Type	SDHC memory card
		Capacity	8 GB
	NZ1MEM-16GBSD	Type	SDHC memory card
		Capacity	16 GB





Battery

Model/Appearance	Contents
FX3U-32BL 	The battery can be used to retain (latch) the status of the device memory or clock data before a power failure. At the time of delivery from the factory, the battery is not built in the CPU module. Please make arrangements if required. Setting of parameter is required for power failure retention.

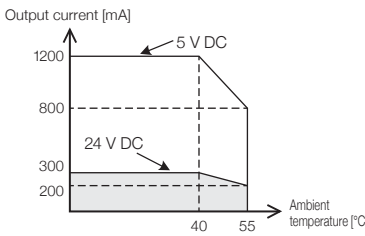
Extension Device

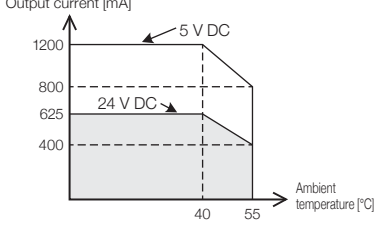
The extension cable for connecting to the right side of the front-stage device has been attached to the extension module (extension cable type).

Model/Characteristics	Items	Specifications	
◆ Bus Conversion Module			
FX5-CNV-BUS (FX5 (extension cable type) – FX3 extension)  Conversion module for connecting FX3 extension module to FX5U and FX5UC CPU modules.	Compatible CPU module	FX5U, FX5UC Connection with FX5UC requires FX5-CNV-IFC or FX5-C1PS-5V.	
	No. of occupied I/O points	8 points (countable either by input or output)	
	No. of connectable modules	Max. 1 module	
	Current consumption (internal supply)	5 V DC 150 mA	
	External dimensions W × H × D (mm)	16 × 90 × 83	
	MASS (Weight): kg	Approx. 0.1	
FX5-CNV-BUSC (FX5 (extension connector type) – FX3 extension)  Conversion module for connecting FX3 extension modules to FX5U and FX5UC CPU modules.	Compatible CPU module	FX5U, FX5UC Connection with FX5U requires FX5-CNV-IF.	
	No. of occupied I/O points	8 points (countable either by input or output)	
	No. of connectable modules	Max. 1 module	
	Current consumption (internal supply)	5 V DC 150 mA	
	External dimensions W × H × D (mm)	16 × 90 × 83	
	MASS (Weight): kg	Approx. 0.1	
◆ Extension Power Supply Module			
FX5-1PSU-5V  Module for extending power supply if FX5U (AC power supply type) CPU module's internal power supply is insufficient. Extension cable is enclosed. Derating diagram 	Rated power supply voltage	100 to 240 V AC	
	Allowable power supply voltage range	85 to 264 V AC	
	Rated frequency	50/60 Hz	
	Allowable instantaneous power failure time	Operation can be continued upon occurrence of instantaneous power failure for 10 ms or less.	
	Power fuse	250 V 3.15 A time lag fuse	
	Rush current	Max. 25 A 5 ms or less/100 V DC Max. 50 A 5 ms or less/200 V DC	
	Power consumption	Max. 20 W	
	Current output (back-stage supply)	24 V DC	300 mA (Maximum output current depends on the ambient temperature.)
		5 V DC	1200 mA (Maximum output current depends on the ambient temperature.)
	Compatible CPU module	FX5U (AC power supply type)	
	No. of occupied I/O points	0 points (No occupied points)	
	No. of connectable modules	Max. 2 modules	
	External dimensions W × H × D (mm)	50 × 90 × 83	
MASS (Weight): kg	Approx. 0.3		

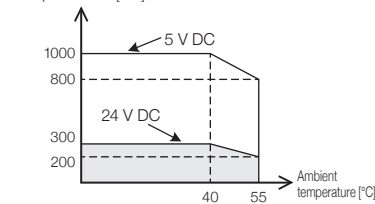

Model/Characteristics	Items	Specifications	
<p>FX5-C1PS-5V</p>  <p>This is an extension power supply which is added when the built-in power supply of the DC power supply type FX5U/FX5UC CPU module is insufficient. Only one of the connector connection and cable connection can be used for the next-stage extension connector of the extension power supply module.</p> <p>Derating diagram</p> 	Power supply voltage	24 V DC	
	Voltage variation range	+20%, -15%	
	Allowed time duration at instantaneous power failure	Operation can be continued upon occurrence of instantaneous power failure for 5 ms or less.	
	Power fuse	125 V 3.15 A time lag fuse	
	Rush current	Max. 35 A 0.5 ms or less/24 V DC	
	Power consumption	Max. 30 W	
	Current output (back-stage supply)	24 V DC	625 mA (Maximum output current depends on the ambient temperature.)
		5 V DC	1200 mA (Maximum output current depends on the ambient temperature.)
	Compatible CPU module	FX5U (DC power supply type), FX5UC	
	No. of occupied I/O points	0 points (No occupied points)	
	No. of connectable modules	Max. 2 modules	
	External dimensions W × H × D (mm)	20.1 × 90 × 74	
	MASS (Weight): kg	Approx. 0.1	
◆ Connector Conversion Module			
<p>FX5-CNV-IF (FX5 (extension cable type) – FX5 (Extension connector type))</p>  <p>Converts the connector for connecting an extension connector type for FX5.</p>	Compatible CPU module	FX5U	
	No. of occupied input/output points	0 points (No occupied I/O)	
	No. of connectable modules	Max. 1 module	
	Current consumption (internal supply)	0 mA (no power consumed)	
	External dimensions W × H × D (mm)	14.6 × 90 × 74	
	MASS (Weight): kg	Approx. 0.06	
<p>FX5-CNV-IFC (FX5 (extension connector type) – FX5 (extension cable type))</p>  <p>Converts the connector for connecting an extension cable type for FX5.</p>	Compatible CPU module	FX5UC	
	No. of occupied I/O points	0 points (No occupied I/O)	
	No. of connectable modules	Max. 1 module	
	Current consumption (internal supply)	0 mA (no power consumed)	
	External dimensions W × H × D (mm)	14.6 × 90 × 74	
	MASS (Weight): kg	Approx. 0.06	
◆ Extension Power Supply Module (for FX3 Extension Module)			
<p>FX3U-1PSU-5V</p>  <p>For extension of power supply when power supply for FX3 extension module is insufficient.</p> <p>Derating diagram</p> 	Power supply voltage	100 to 240 V AC	
	Allowable power supply voltage range	85 to 264 V AC	
	Rated frequency	50/60 Hz	
	Allowable instantaneous power failure time	Conditions vary depending on power sources as follows: <ul style="list-style-type: none"> 100 V AC power supply: Operation can be continued upon occurrence of instantaneous power failure for 10 ms or less. 200 V AC power supply: Operation can be continued upon occurrence of instantaneous power failure for 100 ms or less. 	
	Rush current	Max. 30 A 5 ms or less/100 V AC Max. 65 A 5 ms or less/200 V AC	
	Power consumption	Max. 20 W	
	Current output (back-stage supply)	24 V DC	0.3 A (Derate the maximum output current at an ambient temperature of 40°C or above.)
		5 V DC	1 A (Derate the maximum output current at an ambient temperature of 40°C or above.)
	Compatible CPU module	FX5U (AC power supply type)	
	No. of occupied I/O points	0 points (No occupied points)	
	No. of connectable modules	Max. 2 modules	
	External dimensions W × H × D (mm)	55 × 90 × 87	
	MASS (Weight): kg	Approx. 0.3	

Extension Module Options (Extended Extension Cables/Connector Conversion Adapters)

FX5 extension modules (extension cable type) are equipped with the extension cable for connection to the right side of the front-stage device.

If intending extension of the connection distance or two-row placement of PLCs, an optional "Extended extension cable" is required. Only a single extended extension cable can be used per system.

◇ Extended extension cable

Model	Specifications
FX5-30EC (30 cm) FX5-65EC (65 cm) 	◇ Extended extension cable Extension cable for the FX5 extension module. Only a single cable can be used per system. Depending on the CPU module to be used or the device to be connected with, the following connection conversion adapter (FX5-CNV-BC) is required. [Connector conversion adapter required] When the connection destination is an input/output module (extension cable type), high-speed pulse I/O module, or FX5 intelligent function module
FX5-CNV-BC 	● Connector conversion adapter This connects between an extension cable and an extension cable type module when an extended extension cable is used.

◇ Main connection methods

- 1) Connections with the Powered I/O module and FX5 extension power supply module (extension cable type)

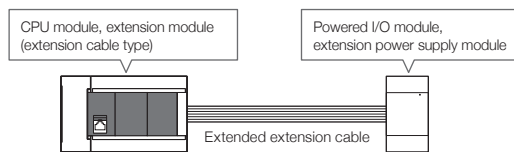

- 2) Connections with the input/output module (extension cable type) and FX5 intelligent function module

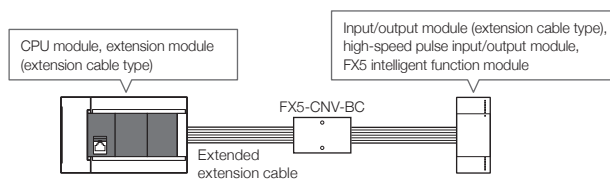

- 3) Connections with the input/output module (extension cable type) and FX5 intelligent function module

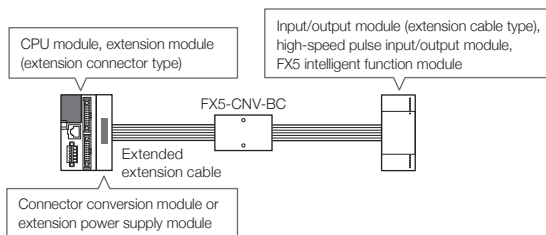

Terminal Module

This allows conversion of the connector of the FX5UC CPU module or the I/O module (extension connector type) to the screw terminal block, resulting in the reduced number of man-hours for I/O wiring.
Using an internal type of I/O element enables driving of a heavy load by a relay or a transistor.

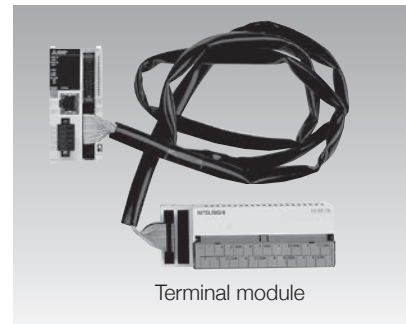

Terminal module

◇ **List of Terminal Modules** (Refer to the next page for the details of connection cables and optional connectors.)

Model	No. of input points	No. of output points	Function
FX-16E-TB	Input 16 points or output 16 points		Directly connected to the I/O terminal of PLC.
FX-32E-TB	Input 32 points or output 32 points (Division possible: input 16 points and output 16 points)		Using this module instead of the PLC terminals or relaying a wiring of I/O device located remotely from PLC enables reducing of the I/O wiring man-hours.
FX-16E-TB/UL	Input 16 points or output 16 points		
FX-32E-TB/UL	Input 32 points or output 32 points (Division possible: input 16 points and output 16 points)		
FX-16EYR-TB	—	16	Relay Output Type
FX-16EYS-TB	—	16	Triac Output Type
FX-16EYT-TB	—	16	Transistor Output Type (Sink output)
FX-16EYR-ES-TB/UL	—	16	Relay Output Type
FX-16EYS-ES-TB/UL	—	16	Triac Output Type
FX-16EYT-ES-TB/UL	—	16	Transistor Output Type (Sink output)
FX-16EYT-ESS-TB/UL	—	16	Transistor Output Type (Source output)

◇ Specifications

1. PLC Direct Connection (FX-16E-TB, FX-32E-TB)

Since it is for direct connection of PLC I/O terminal, no electrical components are built in.

Electrical specifications are equivalent to that of the connected CPU module or connector type I/O module. A drawing on the right shows the internal connection of FX-16E-TB. In case of FX-32E-TB, CN2 is provided with the same connection.

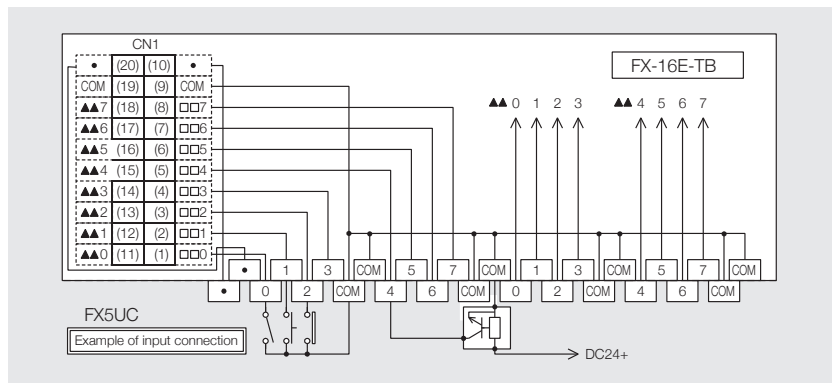



2. Output (FX-16EY□-TB)

Model	Relay output FX-16EYR-TB		Triac output FX-16EYS-TB		Transistor output (Sink output) FX-16EYT-TB	
	I/O circuit configuration		I/O circuit configuration		I/O circuit configuration	
Load voltage	250 V AC 30 V DC or less		85 V to 242 V AC		5 V to 30 V DC	
Circuit isolation	Mechanical isolation		Photocoupler isolation		Photocoupler isolation	
Operation display	An LED is turned on when applying an electrical current to a relay coil		An LED is turned on when applying an electrical current to a phototriac		An LED is turned on when applying an electrical current to a photocoupler	
Max. load	Resistance load	2 A/1 point 8 A/4 points	0.3 A/1 point 0.8 A/4 points		0.5 A/1 point 0.8 A/4 points	
	Inductive load	80 VA	15 VA/100 V AC, 36VA/240 V AC		12 W/24 V DC	
Open circuit leakage current	—		1 mA/A/100 V AC, 2 mA/200 V AC		0.1 mA/30 V DC	
Min. load	5 V DC, 2 mA (reference value)		0.4 VA/100 V AC, 1.6 VA/200 V AC		—	
Response time	OFF → ON	Approx. 10 ms	2 ms or less		0.2 ms or less	
	ON → OFF	Approx. 10 ms	12 ms or less		1.5 ms or less	
Input signal current	5 mA/24 V DC for each point (current consumption)		7 mA/24 V DC for each point (current consumption)		7 mA/24 V DC for each point (current consumption)	



Option/Related Products

I/O Cable

Model/Appearance	Contents
FX-16E-500CAB-S (5 m) 	<ul style="list-style-type: none"> ● General-purpose I/O Cable <p>A 20-pin connector attached to one end of bulk wire</p>
FX-16E-150CAB (1.5 m) FX-16E-300CAB (3 m) FX-16E-500CAB (5 m) 	<ul style="list-style-type: none"> ● I/O Cable for Terminal Module <p>A 20-pin connector attached to both ends of a flat cable (with tube)</p>
FX-16E-150CAB-R (1.5 m) FX-16E-300CAB-R (3 m) FX-16E-500CAB-R (5 m) 	<ul style="list-style-type: none"> ● I/O Cable for Terminal Module <p>A 20-pin connector attached to both ends of round multi core cable</p>

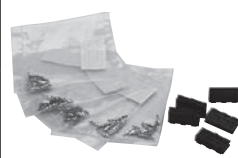

I/O Connector

Model/Appearance	Contents
<ul style="list-style-type: none"> ◆ Connector for self-manufactured I/O cable 20-pin type (electric wire or crimp tool is not enclosed.) 	
FX2C-I/O-CON 	<ul style="list-style-type: none"> ● Flat Cable Connector <p>AWG28 (0.1 mm²): A set of 10 pcs</p> <ul style="list-style-type: none"> ● Crimp connector: FRC2-A020-3OS 1.27-pitch 20 cores ● Crimp tool: Separately arrange the tool manufactured by DDK Ltd. 357J-4674D Main Module 357J-4664N Attachment
(1) FX2C-I/O-CON-S (2) FX2C-I/O-CON-SA 	<p>(1) Connector for single wires AWG22 (0.3 mm²): 5 sets</p> <ul style="list-style-type: none"> ● Housing: HU-200S2-001 ● Crimp contact: HU-411S ● Crimp tool: A product manufactured by DDK Ltd. is separately required. 357J-5538 <p>(2) Connector for single wires AWG20 (0.5 mm²): 5 sets</p> <ul style="list-style-type: none"> ● Housing: HU-200S2-001 ● Crimp contact: HU-411SA ● Crimp tool: A product manufactured by DDK Ltd. is separately required. 357J-13963

Model/Appearance	Contents
<ul style="list-style-type: none"> ◆ Connector for self-manufactured I/O cable: 40-pin type (electric wire or crimp tool is not enclosed.) 	
(1) A6CON1* (2) A6CON2 (3) A6CON4* 	<p>(1) Soldered type connector (straight protrusion) Twist wire 0.088 to 0.3 mm² (AWG28 to 22)</p> <p>(2) Crimped type connector (straight protrusion) Twist wire 0.088 to 0.24 mm² (AWG28 to 24)</p> <p>(3) Soldered type connector (both straight/inclined protrusion type) Twist wire 0.088 to 0.3 mm² (AWG28 to 22)</p>
<p>For FX5-20PG-P, FX5-20PG-D</p>	
(1) FX-I/O-CON2-S (2) FX-I/O-CON2-SA 	<p>(1) Connector for single wires AWG22 (0.3 mm²): 2 sets</p> <ul style="list-style-type: none"> ● Housing: HU-400S2-001 ● Crimp contact: HU-411S ● Crimp tool: A product manufactured by DDK Ltd. is separately required. 357J-5538 <p>(2) Connector for single wires AWG20 (0.5 mm²): 2 sets</p> <ul style="list-style-type: none"> ● Housing: HU-400S2-001 ● Crimp contact: HU-411SA ● Crimp tool: A product manufactured by DDK Ltd. is separately required. 357J-13963
<p>(For FX3U-2HC)</p>	

*: Select wires with a sheath outside diameter of 1.3 mm or less when using 40 wires. Select wires suitable to the current value used.







Power Cable

Model/Appearance	Contents
<p>FX2NC-100MPCB (1 m)</p> 	<p>●CPU Module Power Cable</p> <p>Cable for providing 24 V DC power supply to the FX5UC CPU module. Comes with the FX5UC CPU modules and intelligent function modules*.</p>
<p>FX2NC-100BPCB (1 m)</p> 	<p>●Power Cable</p> <p>Cable for supplying 24 V DC input power supply to an extension connector type input module or input/output module. Offered as an accessory of FX5UC-□MT/D. It is necessary to purchase this cable separately when using an extension connector type input module or input/output module in the FX5U system.</p>
<p>FX2NC-10BPCB1 (0.1 m)</p> 	<p>●Power Supply Transition Cable</p> <p>Cable for crossover wiring of 24 V DC input power supply to two or more extension connector type input modules or input/output modules. Offered as an accessory of FX5-C□EX/D and FX5-C32ET/D.</p>

*: There are some exception models. For details, refer to the manual.

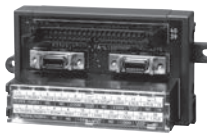
Option/Related Products

Related products Reduced wiring and man-hour saving machines for programmable controllers (FA goods) [manufactured by Mitsubishi Electric Engineering]

Model name/external appearance	Description
FA-CBLQ75PM2J3 (2 m) FA-CBLQ75M2J3 (-P) (2 m) 	<ul style="list-style-type: none"> ●Connection cable <p>Mitsubishi Electric MR-J3-A/J4-A series</p> <ul style="list-style-type: none"> ●Connectable models <p>FA-CBLQ75PM2J3: FX5-20PG-P FA-CBLQ75M2J3 (-P): FX5-20PG-D</p>
FA-CBLQ75G2 (-P) (2 m) 	<ul style="list-style-type: none"> ●Connection cable <p>General-purpose stepping motor, discrete wire cable for servo amplifier</p> <ul style="list-style-type: none"> ●Connectable models <p>FX5-20PG-P, FX5-20PG-D</p>
FA-LTBQ75DP 	<ul style="list-style-type: none"> ●Positioning signal conversion module <p>Converts the external device connection signal of the positioning module to the terminal block and converts the signal between the servo amplifiers to the connect.</p>
FA-CBL05Q7 (0.5 m) FA-CBL10Q7 (1 m) 	<ul style="list-style-type: none"> ●Positioning signal conversion module <p>Connection cable between positioning signal conversion modules</p>
FA-CBLQ7PM1J3 (1 m) FA-CBLQ7DM1J3 (1 m) 	<ul style="list-style-type: none"> ●Positioning signal conversion module <p>Connection cable between servo amplifiers (for Mitsubishi Electric MR-J3-A/J4-A series)</p>
FA-CBLQ7DG1 (1 m) 	<ul style="list-style-type: none"> ●Positioning signal conversion module <p>Connection cable between servo amplifiers (for general-purpose stepping motor and servo amplifier)</p>

Overseas service system

Mitsubishi Electric's Micro PLC Series is a worldwide programmable controller that is used in more than 50 countries all over the world.

For local after-sales services in the overseas countries, "Mitsubishi Electric Global FA Centers" timely provide the best possible products, high technology and reliability services to our customers.

Global FA Center

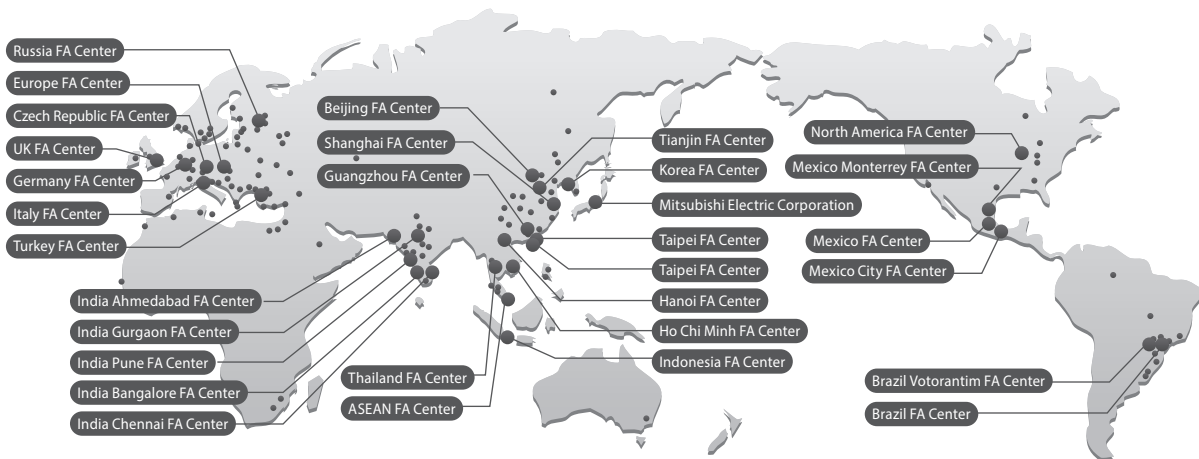

◇ FA Global Service Network "Place contact our FA Center first."

For consultation and questions, please contact our FA centers in each country. With our FA centers in each region of the world as key stations, we provide various services to customers while working closely with local sales offices, branches and agencies.

◇ Detailed information on overseas service

- (1) "FA global service" (KK001-EN)
Service contents and contact information of our FA centers are detailed. For more information on overseas support, please request this document.

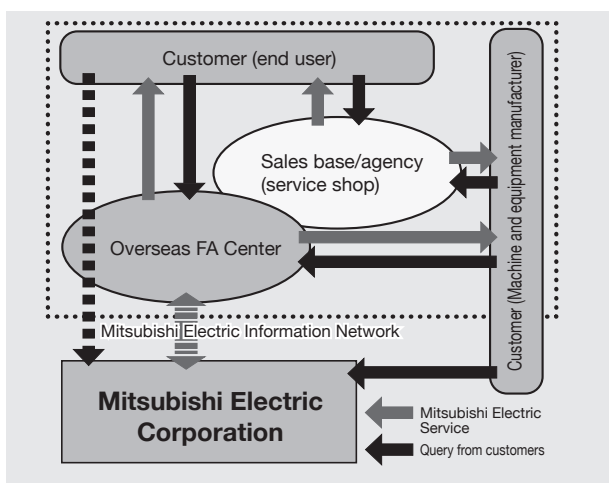

Overseas service system/compatible products

Certifications

MELSEC iQ-F Series conforms to European Standards (EN) and North American Standards (UL/cUL). Using MELSEC iQ-F Series can reduce the workload to make machines/equipment conform to EN and UL/cUL standards.

◇ Compatible with international standards

The MELSEC iQ-F series conforms to CE marking (Europe) and UL/cUL standard (USA, Canada) and therefore can be used for overseas facilities.



◇ EN standards: Compliance with EC Directives/CE marking

EC directives are issued by the European Council of Ministers for the purpose of unifying European national regulations and smoothing distribution of safe guaranteed products. Approximately 20 types of major EC directives concerning product safety have been issued.

Attachment of a CE mark (CE marking) is mandatory on specific products before they may be distributed in the EU. The EMC Directive (Electromagnetic Compatibility Directive) and LVD Directive (Low Voltage Directive) apply to the programmable controller, which is labeled as an electrical part of a machine product under the EC Directives/

1) EMC Directive

The EMC Directive is a directive that requires products to have “Capacity to prevent output of obstructive noise that adversely affects external devices: Emission damage” and “Capacity to not malfunction due to obstructive noise from external source: Immunity”.

2) LVD Directive (Low Voltage Directive)

The LVD Directive is enforced to distribute safe products that will not harm or damage people, objects or assets, etc. With the programmable controller, this means a product that does not pose a risk of electric shock, fire or injury, etc.



◇ **UL/cUL Standards**

UL is the United State’s main private safety testing and certification agency for ensuring public safety.

UL sets the safety standards for a variety of fields. Strict reviews and testing are performed following the standards set forth by UL. Only products which pass these tests are allowed to carry the UL Mark.

As opposed to the EN Standards, the UL Standards do not have a legally binding effect. However, they are broadly used as the U.S. safety standards, and are an essential condition for selling products into the U.S.

UL is recognized as a certifying and testing agency by the Canadian Standards Association (CSA). Products evaluated and certified by UL in accordance with Canadian standards are permitted to carry the cUL Mark.

[Precautions on the use in UL/cUL Class I, Division 2 environment]

Products* marking Cl. I, DIV.2 indicating that they can be used in the Class I, Division 2 (filling in a flammable environment in case of abnormalities) on the rating plate can be used in Class I, Division 2 Group A, B, C, and D only. They can be used regardless of the display as long as they do not reach the danger.

Note that when using a product in Class I, Division 2 environment, the following measures need to be taken for the risk of explosion.

- As this product is an open-type device, attach it to the control board suitable for the installation environment and, for opening, to the control board which requires a tool or key.
- Substitution of products other than Class I, Division 2 compatible may result in degradation of Class I, Division 2 compliance. Therefore, do not substitute products other than compatible products.
- Do not disconnect/connect the device or disconnect the external connection terminal except when the power is turned off or where there is no danger.
- Do not open the battery except where it is out of reach of danger.



*: UL explosion-proof standard compliant products are as follows. (Manufactured in October 2017 and after)

- FX5CPU module
- FX5UC-32MT/D, FX5UC-32MT/DSS, FX5UC-64MT/D, FX5UC-64MT/DSS, FX5UC-96MT/D, and FX5UC-96MT/DSS
- FX5 extension module
- FX5-C16EX/D, FX5-C16EX/DS, FX5-C16EYT/D, FX5-C16EYT/DSS, FX5-C32EX/D, FX5-C32EX/DS, FX5-C32EYT/D, FX5-C32EYT/DSS, FX5-C32ET/D, FX5-C32ET/DSS, FX5-232ADP, FX5-485ADP, FX5-C1PS-5V, FX5-CNV-BUSC, FX5-4AD-ADP, and FX5-4DA-ADP

◇ **Ship standards**

The MELSEC iQ-F series complies with the shipping standards of each country.

It can be used for ship-related machinery and equipment.

Standard abbreviation	Standard name	Target country
DNV GL	Det Norske Veritas Germanischer Lloyd	Norway/Germany
RINA	REGISTRO ITALIANO NAVALE	Italy
ABS	American Bureau of Shipping	U.S.A.
LR	Lloyd’s Register of Shipping	U.K.
BV	Bureau Veritas	France
NK	Nippon Kaiji Kyokai	Japan
KR	Korea Ship Association	Korea

◇ **“ISO9001” international standard for quality-assurance system**

Mitsubishi Electric Corporation Nagoya Works has acquired “ISO9001” international standard for quality-assurance system for the development/manufacture on the whole from order reception to shipment of all series of micro sequencer. Of the ISO9000 series by which the International Organization for Standardization (ISO) defines the standards of quality-assurance systems, “ISO9001” assumes a wide range of quality-assurance systems related to development, manufacture, materials, quality and sales. The MELSEC iQ-F Series is manufactured under the control system based on an internationally recognized quality-assurance system. It is also used as a registration site of “ISO14001” environmental management system.

◇ **Korean Certification Mark (KC Mark)**

- The KC mark, which is a safety certification mark required to be affixed to the specified products distributed in Korea (products required to be legally certificated for safety, quality, environment, etc.), indicates compliance with various requirements.
- KC mark is indicated on FA products, which conform to the Radio Act. Note that other standards are not applicable.

List of compatible products

Model	CE		UL cUL	KC	Ship approvals							
	EMC	LVD			ABS	DW GL	LR	BV	RINA	NK	KR	
◆FX5U CPU modules												
FX5U-32MR/ES	○	○	○	○	○	○	○	○	○	○	○	
FX5U-32MT/ES	○	○	○	○	○	○	○	○	○	○	○	
FX5U-32MT/ESS	○	○	○	○	○	○	○	○	○	○	○	
FX5U-32MR/DS	○	○	○	○	○	○	○	○	○	○	○	
FX5U-32MT/DS	○	□	○	○	○	○	○	○	○	○	○	
FX5U-32MT/DSS	○	□	○	○	○	○	○	○	○	○	○	
FX5U-64MR/ES	○	○	○	○	○	○	○	○	○	○	○	
FX5U-64MT/ES	○	○	○	○	○	○	○	○	○	○	○	
FX5U-64MT/ESS	○	○	○	○	○	○	○	○	○	○	○	
FX5U-64MR/DS	○	○	○	○	○	○	○	○	○	○	○	
FX5U-64MT/DS	○	□	○	○	○	○	○	○	○	○	○	
FX5U-64MT/DSS	○	□	○	○	○	○	○	○	○	○	○	
FX5U-80MR/ES	○	○	○	○	○	○	○	○	○	○	○	
FX5U-80MT/ES	○	○	○	○	○	○	○	○	○	○	○	
FX5U-80MT/ESS	○	○	○	○	○	○	○	○	○	○	○	
FX5U-80MR/DS	○	○	○	○	○	○	○	○	○	○	○	
FX5U-80MT/DS	○	□	○	○	○	○	○	○	○	○	○	
FX5U-80MT/DSS	○	□	○	○	○	○	○	○	○	○	○	
◆FX5UC CPU modules												
FX5UC-32MR/DS-TS	○	○	○	○	—	—	—	—	—	—	—	
FX5UC-32MT/D	○	□	○	○	○	○	○	○	○	○	○	
FX5UC-32MT/DS-TS	○	□	○	○	○	○	○	○	○	○	○	
FX5UC-32MT/DSS	○	□	○	○	○	○	○	○	○	○	○	
FX5UC-32MT/DSS-TS	○	□	○	○	○	○	○	○	○	○	○	
FX5UC-64MT/D	○	□	○	○	○	○	○	○	○	○	○	
FX5UC-64MT/DSS	○	□	○	○	○	○	○	○	○	○	○	
FX5UC-96MT/D	○	□	○	○	○	○	○	○	○	○	○	
FX5UC-96MT/DSS	○	□	○	○	○	○	○	○	○	○	○	
◆FX5 I/O modules (terminal block type)												
FX5-8EX/ES	○	□	○	○	○	○	○	○	○	○	○	
FX5-8EYR/ES	○	○	○	○	○	○	○	○	○	○	○	
FX5-8EYT/ES	○	□	○	○	○	○	○	○	○	○	○	
FX5-8EYT/ESS	○	□	○	○	○	○	○	○	○	○	○	
FX5-16EX/ES	○	□	○	○	○	○	○	○	○	○	○	
FX5-16EYR/ES	○	○	○	○	○	○	○	○	○	○	○	
FX5-16EYT/ES	○	□	○	○	○	○	○	○	○	○	○	
FX5-16EYT/ESS	○	□	○	○	○	○	○	○	○	○	○	
FX5-16ET/ES-H	○	□	○	○	○	○	○	○	○	○	○	
FX5-16ET/ESS-H	○	□	○	○	○	○	○	○	○	○	○	
FX5-16ER/ES	○	○	○	○	○	○	○	○	○	○	○	
FX5-16ET/ES	○	□	○	○	○	○	○	○	○	○	○	
FX5-16ET/ESS	○	□	○	○	○	○	○	○	○	○	○	
FX5-32ER/ES	○	○	○	○	○	○	○	○	○	○	○	
FX5-32ET/ES	○	○	○	○	○	○	○	○	○	○	○	
FX5-32ET/ESS	○	○	○	○	○	○	○	○	○	○	○	
FX5-32ER/DS	○	○	○	○	○	○	○	○	○	○	○	
FX5-32ET/DS	○	□	○	○	○	○	○	○	○	○	○	
FX5-32ET/DSS	○	□	○	○	○	○	○	○	○	○	○	
◆FX5 I/O modules (connector type)												
FX5-C16EX/D	○	□	○	○	○	○	○	○	○	○	○	
FX5-C16EX/DS	○	□	○	○	○	○	○	○	○	○	○	
FX5-C16EYT/D	○	□	○	○	○	○	○	○	○	○	○	
FX5-C16EYT/DSS	○	□	○	○	○	○	○	○	○	○	○	
FX5-C16EYR/D-TS	○	○	○	○	—	—	—	—	—	—	—	
FX5-C32EX/D	○	□	○	○	○	○	○	○	○	○	○	
FX5-C32EX/DS	○	□	○	○	○	○	○	○	○	○	○	
FX5-C32EX/DS-TS	○	□	○	○	○	○	○	○	○	○	○	
FX5-C32EYT/D	○	□	○	○	○	○	○	○	○	○	○	
FX5-C32EYT/D-TS	○	□	○	○	○	○	○	○	○	○	○	
FX5-C32EYT/DSS	○	□	○	○	○	○	○	○	○	○	○	
FX5-C32EYT/DSS-TS	○	□	○	○	○	○	○	○	○	○	○	
FX5-C32ET/D	○	□	○	○	○	○	○	○	○	○	○	
FX5-C32ET/DS-TS	○	□	○	○	○	○	○	○	○	○	○	
FX5-C32ET/DSS	○	□	○	○	○	○	○	○	○	○	○	
FX5-C32ET/DSS-TS	○	□	○	○	○	○	○	○	○	○	○	

Model	CE		UL cUL	KC	Ship approvals							
	EMC	LVD			ABS	DW GL	LR	BV	RINA	NK	KR	
◆FX5 intelligent function module												
FX5-4AD	○	□	○	○	○	○	○	○	○	—	○	
FX5-4DA	○	□	○	○	○	○	○	○	○	○	○	
FX5-8AD	○	□	○	○	○	○	○	○	○	○	○	
FX5-4LC	○	□	○	○	—	—	—	—	—	—	—	
FX5-20PG-P	○	□	○	○	—	—	—	—	—	—	—	
FX5-20PG-D	○	□	○	○	—	—	—	—	—	—	—	
FX5-40SSC-S	○	□	○	○	—	—	—	—	—	—	—	
FX5-80SSC-S	○	□	○	○	—	—	—	—	—	—	—	
FX5-ENET	○	□	○	○	—	—	—	—	—	—	—	
FX5-ENET/IP	○	□	○	○	—	—	—	—	—	—	—	
FX5-CCL-MS	○	□	○ ^{*1}	○	○	○	○	○	○	—	○	
FX5-CCLIEF	○	□	○	○	—	—	—	—	—	—	—	
FX5-ASL-M	○	□	○	○	—	—	—	—	—	—	—	
FX5-DP-M	○	□	○	○	—	—	—	—	—	—	—	
◆FX5 extension power supply module												
FX5-1PSU-5V	○	○	○	○	○	○	○	○	○	○	○	
FX5-C1PS-5V	○	□	○	○	○	○	○	○	○	○	○	
◆FX5 bus conversion module												
FX5-CNV-BUS	○	□	○	○	○	○	○	○	○	○	○	
FX5-CNV-BUSC	○	□	○	○	○	○	○	○	○	○	○	
◆FX5 connector conversion module												
FX5-CNV-IF	○	□	○	○	○	○	○	○	○	○	○	
FX5-CNV-IFC	○	□	○	○	○	○	○	○	○	○	○	
◆FX5 connector conversion adapter												
FX5-CNV-BC	○	□	—	○	○	○	○	○	○	○	○	
◆FX5 extended extension cable												
FX5-30EC	○	□	—	—	—	—	—	—	—	—	—	
FX5-65EC	○	□	—	—	—	—	—	—	—	—	—	
◆FX5 expansion adapter												
FX5-4AD-ADP	○	□	○	○	○	○	○	○	○	○	○	
FX5-4AD-PT-ADP	○	□	○	○	○	○	○	○	○	○	○	
FX5-4AD-TC-ADP	○	□	○	○	○	○	○	○	○	○	○	
FX5-4DA-ADP	○	□	○ ^{*2}	○	○	○	○	○	○	○	○	
FX5-232ADP	○	□	○	○	○	○	○	○	○	○	○	
FX5-485ADP	○	□	○	○	○	○	○	○	○	○	○	
◆FX5U expansion board												
FX5-232-BD	○	□	—	○	○	○	○	○	○	○	○	
FX5-485-BD	○	□	—	○	○	○	○	○	○	○	○	
FX5-422-BD-GOT	○	□	—	○	○	○	○	○	○	○	○	

○ : Compliant with standards or self-declaration □ : No need to comply
 *1: The products (product number: 1760001) manufactured in June 2017 and after complies with the UL standards (UL, cUL).
 *2: The products (product number: 1660001) manufactured in June 2016 and after complies with the UL standards (UL, cUL).

Performance specifications



FX5U **FX5UC**

◆ FX5U/FX5UC CPU module performance specifications

Items		Specifications
Control system		Stored-program repetitive operation
Input/output control system		Refresh system (Direct access input/output allowed by specification of direct access input/output (DX, DY))
Programming specifications	Programming language	Ladder diagram (LD), structured text (ST), function block diagram/ladder language (FBD/LD)
	Programming expansion function	Function block (FB), function (FUN), label programming (local/global)
	Constant scan	0.2 to 2000 ms (can be set in 0.1 ms increments)
	Fixed cycle interrupt	1 to 60000 ms (can be set in 1 ms increments)
	Timer performance specifications	100 ms, 10 ms, 1 ms
Operation specifications	No. of program executions	32
	No. of FB files	16 (Up to 15 for user)
	Execution type	Standby type, initial execution type, scan execution type, fixed-cycle execution type, event execution type
Instruction processing time	Interrupt type	Internal timer interrupt, input interruption, high-speed comparison match interrupt, interrupt from module*1
	LD X0	34 ns*2
Memory capacity	MOV D0 D1	34 ns*2
	Program capacity	64 k/128 k steps (128 kbytes/256 kbytes, flash memory)
	SD memory card	Memory card capacity (SD/SDHC memory card: Max. 16 Gbytes)
	Device/label memory	120 kbytes
Flash memory (Flash ROM) write count	Data memory/standard ROM	5 Mbytes
	Device/label memory	Max. 20000 times
File storage capacity	P: No. of program files	1
	FB: No. of FB files	P: 32, FB: 16
	SD memory card	2 Gbytes: 511*4, 4 G/8 G/16 Gbytes: 65534*4
Clock function	Display data	Year, month, day, hour, minute, second, day of week (leap year automatic detection)
	Precision	Monthly difference: ±45 sec at 25°C (typical value)
No. of input/output points	(1) No. of input/output points	256 points or less/384 points or less*3
	(2) No. of remote I/O points	384 points or less/512 points or less*3
	Total No. of points of (1) and (2)	512 points or less
Power failure retention (Clock data*5)	Retention method	Large-capacity capacitor
	Retention time	10 days (Ambient temperature: 25°C (77°F))
Power failure retention (Device)	Capacity for power failure retention	12 K words maximum*6

*1: Interrupt from the intelligent function module and high-speed pulse input/output module.

*2: When the program capacity is 64 k steps.

*3: Supported by FX5U/FX5UC CPU modules Ver. 1.100 or later and by GX Works3 Ver. 1.047Z or later.

*4: The value listed above indicates the number of files stored in the root folder.

*5: Clock data is retained using the power accumulated in a large-capacity capacitor incorporated into the PLC. When voltage of the large-capacity capacitor drops, clock data is no longer accurately retained. The retention period of a fully charged capacitor (electricity is conducted across the PLC for at least 30 minutes) is 10 days (ambient temperature: 25°C (77°F)). How long the capacitor can hold the data depends on the operating ambient temperature. When the operating ambient temperature is high, the holding period is short.

*6: All devices in the (high-speed) device area can be held against power failure. Devices in the (standard) device area can be held also when the optional battery is mounted.

◆ Number of device points

Items		Base	Max. number of points	
No. of user device points	Input relay (X)	8	1024 points or less	
	Output relay (Y)	8	1024 points or less	
	Internal relay (M)	10	32768 points (can be changed with parameter)*2	
	Latch relay (L)	10	32768 points (can be changed with parameter)*2	
	Link relay (B)	16	32768 points (can be changed with parameter)*2	
	Annunciator (F)	10	32768 points (can be changed with parameter)*2	
	Link special relay (SB)	16	32768 points (can be changed with parameter)*2	
	Step relay (S)	10	4096 points (fixed)	
	Timer system	Timer (T)	10	1024 points (can be changed with parameter)*2
		Accumulation timer system	Accumulation timer (ST)	10
	Counter system	Counter (C)	10	1024 points (can be changed with parameter)*2
		Long counter (LC)	10	1024 points (can be changed with parameter)*2
	Data register (D)	10	8000 points (can be changed with parameter)*2	
	Link register (W)	16	32768 points (can be changed with parameter)*2	
	Link special register (SW)	16	32768 points (can be changed with parameter)*2	
No. of system device points	Special relay (SM)	10	10000 points (fixed)	
	Special register (SD)	10	12000 points (fixed)	
Module access device	Intelligent function module device	10	65536 points (designated by U□/G□)	
No. of index register points	Index register (Z)*3	10	24 points	
	Long index register (LZ)*3	10	12 points	
No. of file register points	File register (F)	10	32768 points (can be changed with parameter)*2	
	Extended file register (ER)	10	32768 points (are stored in SD memory card)	
No. of nesting points	Nesting (N)	10	15 points (fixed)	
No. of pointer points	Pointer (P)	10	4096 points	
	Interrupt pointer (I)	10	178 points (fixed)	
Others	Decimal constant (K)	Signed	16 bits: -32768 to +32767, 32 bits: -2147483648 to +2147483647	
		Unsigned	16 bits: 0 to 65535, 32 bits: 0 to 4294967295	
	Hexadecimal constant (H)		16 bits: 0 to FFFF, 32 bits: 0 to FFFFFFFF	
	Real constant (E) Single precision	—	E-3.40282347+38 to E-1.17549435-38, 0, E1.17549435-38 to E3.40282347+38	
Character string	—	Shift-JIS code max. 255 single-byte characters (256 including NULL)		

*1: Supported by FX5U/FX5UC CPU modules Ver. 1.100 or later and by GX Works3 Ver. 1.047Z or later.

*2: Can be changed with parameters within the capacity range of the CPU built-in memory.

*3: Total of the index register (Z) and long index register (LZ) is maximum 24 words.

List of instructions

◇ CPU module application instruction

Classification	Instruction symbol	Function	Compatible CPU module	
			FX6U	FX6UC
Rotation	ROR(P)	16-bit data right rotation	○	○
	RCR(P)	Right rotation with 16-bit data carry	○	○
	ROL(P)	16-bit data left rotation	○	○
	RLC(P)	Left rotation with 16-bit data carry	○	○
	DROR(P)	32-bit data right rotation	○	○
	DRCR(P)	Right rotation with 32-bit data carry	○	○
	DROL(P)	32-bit data left rotation	○	○
Program branch	CJ(P)	Pointer branch	○	○
	GOEND	Jump to END	○	○
Program execution control	DI	Interrupt disable	○	○
	EI	Interrupt enable	○	○
	DI	Interrupt disable when lower than specified priority	○	○
	IMASK	Interrupt program mask	○	○
	SIMASK	Specified interrupt pointer disable/enable	○	○
	IRET	Return from interrupt program	○	○
Structured instruction	WDT(P)	WDT reset	○	○
	FOR	Executed (n) times between ROM instruction and NEXT instruction	○	○
	NEXT		○	○
	BREAK(P)	FOR to NEXT forced end	○	○
	CALL(P)	Subroutine program call	○	○
	RET	Return from subroutine program	○	○
	SRET		○	○
Data table operation	XCALL	Subroutine program call	○	○
	SFRD(P)	First-in data read from data table	○	○
	POP(P)	Last-in data read from data table	○	○
	SFWR(P)	Data write to data table	○	○
	FINS(P)	Data insertion to data table	○	○
Character string processing	FDEL(P)	Data delete from data table	○	○
	LD\$=	Character string comparison LD (S1) = (S2)	○	○
	LD\$<>	Character string comparison LD (S1) <> (S2)	○	○
	LD\$>	Character string comparison LD (S1) > (S2)	○	○
	LD\$<=	Character string comparison LD (S1) <= (S2)	○	○
	LD\$<	Character string comparison LD (S1) < (S2)	○	○
	LD\$>=	Character string comparison LD (S1) >= (S2)	○	○
	AND\$=	Character string comparison AND (S1) = (S2)	○	○
	AND\$<>	Character string comparison AND (S1) <> (S2)	○	○
	AND\$>	Character string comparison AND (S1) > (S2)	○	○
	AND\$<=	Character string comparison AND (S1) <= (S2)	○	○
	AND\$<	Character string comparison AND (S1) < (S2)	○	○
	AND\$>=	Character string comparison AND (S1) >= (S2)	○	○
	OR\$=	Character string comparison OR (S1) = (S2)	○	○
	OR\$<>	Character string comparison OR (S1) <> (S2)	○	○
	OR\$>	Character string comparison OR (S1) > (S2)	○	○
	OR\$<=	Character string comparison OR (S1) <= (S2)	○	○
	OR\$<	Character string comparison OR (S1) < (S2)	○	○
	OR\$>=	Character string comparison OR (S1) >= (S2)	○	○
	\$+(P)	Combination of character strings	○	○
	\$MOV(P)	Transfer of character string	○	○
	BINDA(P)(L,U)	BIN 16-bit data → Decimal ASCII conversion	○	○
	DBINDA(P)(L,U)	BIN 32-bit data → Decimal ASCII conversion	○	○
	ASCII(P)	HEX code data → ASCII conversion	○	○
	STR(P)(L,U)	BIN 16-bit data → Character string conversion	○	○
	DSTR(P)(L,U)	BIN 32-bit data → Character string conversion	○	○
	ESTR(P)	Single precision actual number →	○	○
	DESTR(P)	Character string conversion	○	○
	LEN(P)	Detection of character string length	○	○
	RIGHT(P)	Extraction from right side of character string	○	○
	LEFT(P)	Extraction from left side of character string	○	○
	MIDR(P)	Extraction of any part from the middle of character string	○	○
	MIDW(P)	Replacement of any part in the middle of character string	○	○
	INSTR(P)	Character string search	○	○
	STRINS(P)	Character string insertion	○	○
	STRDEL(P)	Character string deletion	○	○

Classification	Instruction symbol	Function	Compatible CPU module	
			FX5U	FX5UC
Actual number	LDE\$=	Single precision actual number comparison LDE (S1) = (S2)	○	○
	LDE\$<>	Single precision actual number comparison LDE (S1) <> (S2)	○	○
	LDE\$>	Single precision actual number comparison LDE (S1) > (S2)	○	○
	LDE\$<=	Single precision actual number comparison LDE (S1) <= (S2)	○	○
	LDE\$<	Single precision actual number comparison LDE (S1) < (S2)	○	○
	LDE\$>=	Single precision actual number comparison LDE (S1) >= (S2)	○	○
	ANDE\$=	Single precision actual number comparison ANDE (S1) = (S2)	○	○
	ANDE\$<>	Single precision actual number comparison ANDE (S1) <> (S2)	○	○
	ANDE\$>	Single precision actual number comparison ANDE (S1) > (S2)	○	○
	ANDE\$<=	Single precision actual number comparison ANDE (S1) <= (S2)	○	○
	ANDE\$<	Single precision actual number comparison ANDE (S1) < (S2)	○	○
	ANDE\$>=	Single precision actual number comparison ANDE (S1) >= (S2)	○	○
	ORE\$=	Single precision actual number comparison ORE (S1) = (S2)	○	○
	ORE\$<>	Single precision actual number comparison ORE (S1) <> (S2)	○	○
	ORE\$>	Single precision actual number comparison ORE (S1) > (S2)	○	○
	ORE\$<=	Single precision actual number comparison ORE (S1) <= (S2)	○	○
	ORE\$<	Single precision actual number comparison ORE (S1) < (S2)	○	○
	ORE\$>=	Single precision actual number comparison ORE (S1) >= (S2)	○	○
	DECOMP(P)	Single precision actual number comparison	○	○
	DEZCP(P)	Binary floating point bandwidth comparison	○	○
	E+(P)	Single precision actual number addition	○	○
	E-(P)	Single precision actual number subtraction	○	○
	DEADD(P)	Single precision actual number addition	○	○
	DESUB(P)	Single precision actual number subtraction	○	○
	E*(P)	Single precision actual number multiplication	○	○
	E/(P)	Single precision actual number division	○	○
	DEMUL(P)	Single precision actual number multiplication	○	○
	DEDIV(P)	Single precision actual number division	○	○
	INT2FLT(P)	Signed BIN 16-bit data → Single precision actual number conversion	○	○
	UINT2FLT(P)	Unsigned BIN 16-bit data → Single precision actual number conversion	○	○
	DINT2FLT(P)	Signed BIN 32-bit data → Single-precision real number conversion	○	○
	UDINT2FLT(P)	Unsigned BIN 32-bit data → Single precision actual number conversion	○	○
	EVAL(P)	Character string →	○	○
	DEVAL(P)	Single precision actual number conversion	○	○
	DEBCD(P)	Binary floating point → Decimal floating point conversion	○	○
	DEBIN(P)	Decimal floating point → Binary floating point conversion	○	○
	ENEG(P)	Reverse of single precision actual number sign	○	○
	DENEG(P)		○	○
	EMOV(P)	Transfer of single precision actual number data	○	○
	DEMOV(P)		○	○
	SIN(P)	Single precision actual number SIN operation	○	○
	DSIN(P)		○	○
	COS(P)	Single precision actual number COS operation	○	○
	DCOS(P)		○	○
	TAN(P)	Single precision actual number TAN operation	○	○
	DTAN(P)		○	○
	ASIN(P)	Single precision actual number SIN ⁻¹ operation	○	○
	DASIN(P)		○	○
	ACOS(P)	Single precision actual number COS ⁻¹ operation	○	○
	DACOS(P)		○	○
ATAN(P)	Single precision accuracy TAN ⁻¹ operation	○	○	
DATAN(P)		○	○	
RAD(P)	Single precision actual number angle → Radian conversion	○	○	
DRAD(P)		○	○	
DEG(P)	Single precision actual number radian → Angle conversion	○	○	
DDEG(P)		○	○	
DESQR(P)	Square root of single precision actual number	○	○	
ESQR(P)		○	○	
EXP(P)	Index operation of single precision actual number	○	○	
DEXP(P)		○	○	
LOG(P)	Inferior logarithm operation of single precision actual number	○	○	
DLOGE(P)		○	○	
POW(P)	Exponentiation operation of single precision actual number	○	○	
LOG10(P)	Common logarithm operation of single precision actual number	○	○	
DLOG10(P)		○	○	
EMAX(P)	Search for maximum value of single precision actual number	○	○	
EMIN(P)	Search for minimum value of single precision actual number	○	○	

For sequence instructions and basic instructions, refer to manuals.

Classification	Instruction symbol	Function	Compatible CPU module	
			FX5U	FX5UC
Random number	RND(P)	Random number generation	○	○
Index register operation	ZPUSH(P)	Collective saving of index register	○	○
	ZPOP(P)	Corrective return of index register	○	○
	ZPUSH(P)	Selection and saving of index register/long index register	○	○
	ZPOP(P)	Selection and return of index register/long index register	○	○
Data control	LIMIT(P/L/U)	BIN 16-bit data upper-/lower-limit control	○	○
	DLIMIT(P/L/U)	BIN 32-bit data upper-/lower-limit control	○	○
	BAND(P/L/U)	BIN 16-bit data dead band control	○	○
	DBAND(P/L/U)	BIN 32-bit data dead band control	○	○
	ZONE(P/L/U)	BIN 16-bit data zone control	○	○
	DZONE(P/L/U)	BIN 32-bit data zone control	○	○
	SCL(P/L/U)	BIN 16-bit unit scaling (point-specific coordinate data)	○	○
	DSCL(P/L/U)	BIN 32-bit unit scaling (point-specific coordinate data)	○	○
Special timer	TTMR	Teaching timer	○	○
	STMR	Special function timer	○	○
Special counter	UDCNTF	Signed 32-bit up/down counter	○	○
Shortcut control	ROTC	Rotary table shortcut control	○	○
Inclination signal	RAMPF	Control inclination signal	○	○
Pulse system	SPD	Measurement of BIN 16-bit pulse density	○	○
	DSPD	Measurement of BIN 32-bit pulse density	○	○
	PLSY	BIN 16-bit pulse output	○	○
	DPLSY	BIN 32-bit pulse output	○	○
	PWM	BIN 16 pulse width modulation	○	○
	DPWM	BIN 32-bit pulse width modulation	○	○
Matrix input	MTR	Matrix input	○	○
Initial state	IST	Initial state	○	○
Drum sequence	ABSD	BIN 16-bit data absolute method	○	○
	DABSD	BIN 32-bit data absolute method	○	○
	INCD	Relative method	○	○
Check code	CCD(P)	Check code	○	○
Data processing instruction	SERMM(P)	Data processing instruction	○	○
	DSERMM(P)	32-bit data search	○	○
	SUM(P)	16-bit data bit check	○	○
	DSUM(P)	32-bit data bit check	○	○
	BON(P)	Bit detection of 16-bit data	○	○
	DBON(P)	Bit detection of 32-bit data	○	○
	MAX(P/L/U)	Search for maximum value of 16-bit data	○	○
	DMAX(P/L/U)	Search for maximum value of 32-bit data	○	○
	MIN(P/L/U)	Search for minimum value of 16-bit data	○	○
	DMIN(P/L/U)	Search for minimum value of 32-bit data	○	○
	SORTIBL(U)	16-bit data sort	○	○
	SORTIBL2(U)	16-bit data alignment 2	○	○
	DSORTIBL2(U)	32-bit data alignment 2	○	○
	WSUMP(P/L/U)	16-bit data total value calculation	○	○
	DWSUMP(P/L/U)	32-bit data total value calculation	○	○
	MEAN(P/L/U)	16-bit data average value calculation	○	○
	DMEAN(P/L/U)	32-bit data average value calculation	○	○
	SQRT(P)	Calculation of 16-bit square root	○	○
	DSQRT(P)	Calculation of 32-bit square root	○	○
	CRC(P)	CRC calculation	○	○
Indirect address read	ADRSET(P)	Indirect address read	○	○

Classification	Instruction symbol	Function	Compatible CPU module	
			FX5U	FX5UC
For clock	TRD(P)	Clock data read	○	○
	TWR(P)	Clock data write	○	○
	TADD(P)	Addition of clock data	○	○
	TSUB(P)	Subtraction of clock data	○	○
	HTOS(P)	16-bit data conversion of time data (hour/minute/second → second)	○	○
	DHTOS(P)	32-bit data conversion of time data (hour/minute/second → second)	○	○
	STOH(P)	16-bit data conversion of time data (second → hour/minute/second)	○	○
	DSTOH(P)	32-bit data conversion of time data (second → hour/minute/second)	○	○
	LDDT\$=	Date comparison LDDT (S1) = (S2)	○	○
	LDDT\$<>	Date comparison LDDT (S1) <> (S2)	○	○
	LDDT\$>	Date comparison LDDT (S1) > (S2)	○	○
	LDDT\$<=	Date comparison LDDT (S1) <= (S2)	○	○
	LDDT\$<	Date comparison LDDT (S1) < (S2)	○	○
	LDDT\$>=	Date comparison LDDT (S1) >= (S2)	○	○
	ANDDT\$=	Date comparison ANDDT (S1) = (S2)	○	○
	ANDDT\$<>	Date comparison ANDDT (S1) <> (S2)	○	○
	ANDDT\$>	Date comparison ANDDT (S1) > (S2)	○	○
	ANDDT\$<=	Date comparison ANDDT (S1) <= (S2)	○	○
	ANDDT\$<	Date comparison ANDDT (S1) < (S2)	○	○
	ANDDT\$>=	Date comparison ANDDT (S1) >= (S2)	○	○
	ORDT\$=	Date comparison ORDT (S1) = (S2)	○	○
	ORDT\$<>	Date comparison ORDT (S1) <> (S2)	○	○
	ORDT\$>	Date comparison ORDT (S1) > (S2)	○	○
	ORDT\$<=	Date comparison ORDT (S1) <= (S2)	○	○
	ORDT\$<	Date comparison ORDT (S1) < (S2)	○	○
	ORDT\$>=	Date comparison ORDT (S1) >= (S2)	○	○
	LDTM\$=	Time comparison LDTM (S1) = (S2)	○	○
	LDTM\$<>	Time comparison LDTM (S1) <> (S2)	○	○
	LDTM\$>	Time comparison LDTM (S1) > (S2)	○	○
	LDTM\$<=	Time comparison LDTM (S1) <= (S2)	○	○
	LDTM\$<	Time comparison LDTM (S1) < (S2)	○	○
	LDTM\$>=	Time comparison LDTM (S1) >= (S2)	○	○
	ANDTM\$=	Time comparison ANDTM (S1) = (S2)	○	○
	ANDTM\$<>	Time comparison ANDTM (S1) <> (S2)	○	○
	ANDTM\$>	Time comparison ANDTM (S1) > (S2)	○	○
	ANDTM\$<=	Time comparison ANDTM (S1) <= (S2)	○	○
	ANDTM\$<	Time comparison ANDTM (S1) < (S2)	○	○
	ANDTM\$>=	Time comparison ANDTM (S1) >= (S2)	○	○
	ORTM\$=	Time comparison ORTM (S1) = (S2)	○	○
	ORTM\$<>	Time comparison ORTM (S1) <> (S2)	○	○
ORTM\$>	Time comparison ORTM (S1) > (S2)	○	○	
ORTM\$<=	Time comparison ORTM (S1) <= (S2)	○	○	
ORTM\$<	Time comparison ORTM (S1) < (S2)	○	○	
ORTM\$>=	Time comparison ORTM (S1) >= (S2)	○	○	
TCMP(P)	Clock data comparison	○	○	
TZCP(P)	Clock data bandwidth comparison	○	○	
Timing measurement	DUTY	Timing pulse generation	○	○
	HOURM	Hour meter (BIN 16-bit data)	○	○
Module access	DHOURM	Hour meter (BIN 32-bit data)	○	○
	REF(P)	I/O refresh	○	○
	RFS(P)	I/O refresh	○	○
	FROM(P)	Read of 1-word data from other module (16-bit specified)	○	○
	DFROM(P)	Read of 2-word data from other module (16-bit specified)	○	○
	TO(P)	Write of 1-word data from other module (16-bit specified)	○	○
	DTO(P)	Write of 2-word data from other module (16-bit specified)	○	○
	FROMD(P)	Read of 1-word data from other module (32-bit specified)	○	○
	DFROMD(P)	Read of 2-word data from other module (32-bit specified)	○	○
	TOD(P)	Write of 1-word data from other module (32-bit specified)	○	○
DTOD(P)	Write of 2-word data from other module (32-bit specified)	○	○	

For sequence instructions and basic instructions, refer to manuals.

List of instructions

◇ Step ladder instruction

Classification	Instruction symbol	Function	Compatible CPU module	
			FX5U	FX5UC
Step ladder	STL	Start of step ladder	○	○
	RETSTL	End of step ladder	○	○

◇ Built-in Ethernet function instruction

Classification	Instruction symbol	Function	Compatible CPU module	
			FX5U	FX5UC
Built-in Ethernet function instruction	SP.SOCOPEN	Connection establishment	○	○
	SP.SOCCLOSE	Connection disconnection	○	○
Socket Communication function	SP.SOCRCV	Read of received data during END processing	○	○
	SP.SOCSND	Data transmission	○	○
	SP.SOCCINF	Read of connection information	○	○
	SP.SOCDATA	Read of received data of socket communication	○	○
Communication protocol support function	SP.ECPRTCL	Execution of registration protocol of communication protocol support function	○	○
SLMP frame transmission	SP.SLMPSEND	SLMP message transmission to SLMP-compatible device	○	○
Ethernet module	GP.OPEN	Connection establishment	○	○
	GP.CLOSE	Connection disconnection	○	○
	GP.SOCRCV	Read of received data	○	○
	GP.SOCSND	Data transmission	○	○

◇ PID control instruction

Classification	Instruction symbol	Function	Compatible CPU module	
			FX5U	FX5UC
PID control	PID	PID operation	○	○

◇ List of module dedicated instructions

Classification	Instruction symbol	Function	Compatible CPU module	
			FX5U	FX5UC
CC-Link IE field network	GP.READ	Reading data from the PLC of another station	○	○
	GP.SREAD	Reading data from the PLC of another station (A read notice is issued.)	○	○
	GP.WRITE	Writing data to the PLC of another station	○	○
	GP.SWRITE	Writing data to the PLC of another station (A write notice is issued.)	○	○
	GP.SEND	Transmission of data to the PLC of another station	○	○
	GP.RECV	Reception of data from the PLC of another station	○	○
	GP.CCPASET	Parameter setting	○	○
	GP.UINI	Own station number setting	○	○
High speed counter	DHSCS	32-bit data comparison set	○	○
	DHSCR	32-bit comparison reset	○	○
	DHSZ	32-bit data bandwidth comparison	○	○
	HIOEN(P)	Start and stop of 16-bit data high speed input/output function	○	○
High-speed transfer of current value	DHIOEN(P)	Start and stop of 32-bit data high speed input/output function	○	○
	HCMOV(P)	High-speed transfer of 16-bit data current value	○	○
External device communication	DHCMOV(P)	High-speed transfer of 32-bit data current value	○	○
	RS2	Serial data transfer 2	○	○
Inverter communication	IVCK	Inverter operation monitor	○	○
	IVDR	Inverter operation control	○	○
	IVRD	Inverter parameter read	○	○
	IWR	Inverter parameter write	○	○
	IVBWR	Inverter parameter batch write	○	○
	IMC	Multiple commands of inverter	○	○
MODBUS	ADPRW	MODBUS data read/write	○	○
Communication protocol support function	S(P).CPRTCL	Execution of communication protocol registered by engineering tool	○	○
Positioning	DSZR	Home position return with 16-bit data dog search	○	○
	DDSZR	Home position return with 32-bit data dog search	○	○
	DVIT	16-bit data interrupt positioning	○	○
	DDVIT	32-bit data interrupt positioning	○	○
	TBL	Positioning by 1-table operation	○	○
	DRVITBL	Positioning by multiple-table operation	○	○
	DRVMUL	Multiple axis simultaneous drive positioning	○	○
	DABS	32-bit data ABS current value read	○	○
	PLSV	16-bit data variable speed pulse	○	○
	DPLSV	32-bit data variable speed pulse	○	○
	DRVI	16-bit data relative positioning	○	○
	DDRVI	32-bit data relative positioning	○	○
	DRVA	16-bit data absolute positioning	○	○
	DDRVA	32-bit data absolute positioning	○	○
	G.ABRST1 G.ABRST2	Absolute position restoration of specified axis	○	○
	GP.PSTRT1 GP.PSTRT2	Starting the positioning of specified axis	○	○
	GP.TEACH1 GP.TEACH2	Teaching of specified axis	○	○
GPPFWRT	Backing up the module	○	○	
GP.PINT	Module initialization	○	○	
BFM split read/write	RBFM	BFM split read	○	○
	WBFM	BFM split write	○	○

For sequence instructions and basic instructions, refer to manuals.

Special devices

Typical special relays and special registers are described below.
For details, refer to manual.

List of special relays

◇ Diagnostic information

No.	Name	FX5U	FX5UC
SM0	Latest self diagnosis error (including annunciator ON)	○	○
SM1	Latest self diagnosis error (not including annunciator ON)	○	○
SM50	Error reset	○	○
SM51	Battery low latch	○	○
SM52	Battery low	○	○
SM53	AC/DC DOWN	○	○
SM56	Operation error	○	○
SM61	I/O module verify error	○	○
SM62	Annunciator	○	○

◇ System information

No.	Name	FX5U	FX5UC
SM203	STOP contact	○	○
SM204	PAUSE contact	○	○
SM210	Clock data set request	○	○
SM211	Clock data set error	○	○
SM213	Clock data read request	○	○

◇ System clock

No.	Name	FX5U	FX5UC
SM400	Always ON	○	○
SM401	Always OFF	○	○
SM402	After RUN, ON for one scan only	○	○
SM403	After RUN, OFF for one scan only	○	○
SM409	0.01 sec. clock	○	○
SM410	0.1 sec. clock	○	○
SM411	0.2 sec. clock	○	○
SM412	1 sec. clock	○	○
SM413	2 sec. clock	○	○
SM414	2n sec. clock	○	○
SM415	2n ms clock	○	○

◇ Instruction related

No.	Name	FX5U	FX5UC
SM700	Carry flag	○	○
SM701	Output character count switching	○	○
SM703	Sort order	○	○
SM704	Block comparison	○	○
SM709	DT/TM instruction improper data detection	○	○

◇ For serial communication

No.	Name	FX5U	FX5UC
SM8500	Serial communication error (ch1)	○	○
SM8560	Data transfer delayed (ch1)	○	○
SM8561	Data transfer flag (ch1)	○	○
SM8562	Receive completion flag (ch1)	○	○
SM8563	Carrier detection flag (ch1)	○	○
SM8564	Data set ready flag (ch1)	○	○
SM8565	Time-out check flag (ch1)	○	○
SM8740	Station No. setting SD latch enabled (ch1)	○	○
SM8800	MODBUS RTU communication (ch1)	○	○
SM8801	Retry (ch1)	○	○
SM8802	Timeout (ch1)	○	○
SM8861	Host station No. setting SD latch enabled (ch1)	○	○
SM8920	Inverter communication (ch1)	○	○
SM8921	IBWR instruction error (ch1)	○	○
SM9040	Data communication error (Master station)	○	○
SM9041	Data communication error (Slave station No.1)	○	○

◇ FX compatible area

No.	Name	FX5U	FX5UC
SM8000	RUN monitor NO contact	○	○
SM8001	RUN monitor NC contact	○	○
SM8002	Initial pulse NO contact	○	○
SM8003	Initial pulse NC contact	○	○
SM8004	Error occurrence	○	○
SM8005	Battery voltage low	○	○
SM8006	Battery error latch	○	○
SM8007	Momentary power failure	○	○
SM8008	Power failure detected	○	○
SM8011	10 msec clock pulse	○	○
SM8012	100 msec clock pulse	○	○
SM8013	1 sec clock pulse	○	○
SM8014	1 min clock pulse	○	○
SM8015	Clock stop and preset	○	○
SM8016	Time read display is stopped	○	○
SM8017	±30 seconds correction	○	○
SM8019	Real time clock error	○	○
SM8020	Zero	○	○
SM8021	Borrow	○	○
SM8022	Carry	○	○
SM8023	Real time clock access error	○	○
SM8026	Operation stop mode with one ramp output instruction	○	○
SM8029	Completion of instruction execution	○	○
SM8031	Non-latch memory all clear	○	○
SM8032	Latch memory all clear	○	○
SM8033	Memory hold function when RUN→ STOP	○	○
SM8034	All outputs prohibited	○	○
SM8039	Constant scan mode	○	○
SM8040	For STL: Transition prohibited	○	○
SM8041	For STL: Start of operation during automatic operation	○	○
SM8042	For STL: Start pulse	○	○
SM8043	For STL: Completion of home position return	○	○
SM8044	For STL: Home position condition	○	○
SM8045	For STL: All output reset prohibited during mode switch	○	○
SM8046	For STL: With STL state ON	○	○
SM8047	For STL: STL monitor (SD8040 to SD8047) enabled	○	○
SM8048	Annunciator operation	○	○
SM8049	ON annunciator minimum number enabled	○	○
SM8063	Serial communication error1 (ch1)	○	○
SM8067	Operation error	○	○
SM8068	Operation error latch	○	○

List of special registers

◇ Diagnostic information

No.	Name	FX5U	FX5UC
SD0	Latest self diagnosis error code	○	○
SD1	Clock time for self diagnosis error occurrence (Year)	○	○
SD2	Clock time for self diagnosis error occurrence (Month)	○	○
SD3	Clock time for self diagnosis error occurrence (Day)	○	○
SD4	Clock time for self diagnosis error occurrence (Hour)	○	○
SD5	Clock time for self diagnosis error occurrence (Minute)	○	○
SD6	Clock time for self diagnosis error occurrence (Second)	○	○
SD7	Clock time for self diagnosis error occurrence (Day Week)	○	○

◇ System information

No.	Name	FX5U	FX5UC
SD203	CPU Status	○	○
SD210	Clock Data (Year)	○	○
SD211	Clock Data (Month)	○	○
SD212	Clock Data (Day)	○	○
SD213	Clock Data (Hour)	○	○
SD214	Clock Data (Minute)	○	○
SD215	Clock Data (Second)	○	○
SD216	Clock Data (Day Week)	○	○

◇ System clock

No.	Name	FX5U	FX5UC
SD412	One second counter	○	○
SD414	2n second clock setting	○	○
SD415	2n ms second clock setting	○	○
SD420	Scan counter	○	○

◇ Scan information

No.	Name	FX5U	FX5UC
SD500	Execution program number	○	○
SD520	Current scan time (ms)	○	○
SD521	Current scan time (μs)	○	○
SD522	Minimum scan time (ms)	○	○
SD523	Minimum scan time (μs)	○	○
SD524	Maximum scan time (ms)	○	○
SD525	Maximum scan time (μs)	○	○

◇ For serial communication

No.	Name	FX5U	FX5UC
SD8500	Serial communication error code (ch1)	○	○
SD8501	Serial communication error details (ch1)	○	○
SD8502	Serial communication setting (ch1)	○	○
SD8503	Serial communication operational mode (ch1)	○	○

◇ For built-in Ethernet

No.	Name	FX5U	FX5UC
SD10050	Local node IP address [low-order]	○	○
SD10051	Local node IP address [high-order]	○	○
SD10060	Subnet mask [low-order]	○	○
SD10061	Subnet mask [high-order]	○	○
SD10064	Default gateway IP address [low-order]	○	○
SD10065	Default gateway IP address [high-order]	○	○
SD10074	Local node MAC address	○	○
SD10075	Local node MAC address	○	○
SD10076	Local node MAC address	○	○
SD10082	Communication speed setting	○	○
SD10084	MELSOFT connection TCP port No.	○	○
SD10086	MELSOFT direct connection port No.	○	○

◇ FX compatible area

No.	Name	FX5U	FX5UC
SD8000	Watch dog timer	○	○
SD8001	PLC type and system version	○	○
SD8005	Battery voltage	○	○
SD8006	Low battery voltage	○	○
SD8007	Power failure count	○	○
SD8008	Power failure detection period	○	○
SD8010	Current scan time	○	○
SD8011	Minimum scan time	○	○
SD8012	Maximum scan time	○	○
SD8013	RTC: Seconds	○	○
SD8014	RTC: Minute data	○	○
SD8015	RTC: Hour data	○	○
SD8016	RTC: Day data	○	○
SD8017	RTC: Month data	○	○
SD8018	RTC: Year data	○	○
SD8019	RTC: Day of week data	○	○
SD8039	Constant scan duration	○	○
SD8040	ON state number 1	○	○
SD8041	ON state number 2	○	○
SD8042	ON state number 3	○	○
SD8043	ON state number 4	○	○
SD8044	ON state number 5	○	○
SD8045	ON state number 6	○	○
SD8046	ON state number 7	○	○
SD8047	ON state number 8	○	○
SD8049	Lowest active Annunciator	○	○
SD8063	Serial communication error code (ch1)	○	○
SD8067	Operation error	○	○

General, power supply, input/output specifications

◇ General specifications

Item	Specifications				
	FX5U/FX5UC				
Operating ambient temperature*1	-20 to 55°C (-4 to 131°F), non-freezing*2 *3				
Storage ambient temperature	-25 to 75°C (-13 to 167°F), non-freezing				
Operating ambient humidity	5 to 95%RH, non-condensation*4				
Storage ambient humidity	5 to 95%RH, non-condensation				
Vibration resistance*5 *6	Installed on DIN rail	Frequency	Acceleration	Half amplitude	Sweep count 10 times each in X, Y, Z directions (80 min in each direction)
		5 to 8.4 Hz	—	1.75 mm	
	Direct installing*12	8.4 to 150 Hz	4.9 m/s ²	—	
		5 to 8.4 Hz	—	3.5 mm	
	8.4 to 150 Hz	9.8 m/s ²	—		
Shock resistance*5	147 m/s ² . Action time: 11 ms, 3 times by half-sine pulse in each direction X, Y, and Z				
Noise durability	By noise simulator at noise voltage of 1000 Vp-p, noise width of 1 ms and period of 30 to 100 Hz				
Grounding	Class D grounding (grounding resistance: 100 Ω or less) <Common grounding with a heavy electrical system is not allowed.> *7				
Working atmosphere	Free from corrosive or flammable gas and excessive conductive dust				
Operating altitude*8	0 to 2000 m				
Installation location	Inside a control panel*9				
Overvoltage category*10	II or less				
Pollution degree*11	2 or less				

- *1: The simultaneous ON ratio of available PLC inputs or outputs changes with respect to the ambient temperature. For details, refer to manuals of each product.
- *2: 0 to 55°C for products manufactured before June 2016. For intelligent function modules, refer to the manual of each product.
The following products cannot be used when the ambient temperature is less than 0°C:
FX5-40SSC-S, FX5-80SSC-S, FX5-CNV-BUS, FX5-CNV-BUSC, battery (FX3U-32BL), SD memory cards (NZ1MEM-2GBSD, NZ1MEM-4GBSD, NZ1MEM-8GBSD, NZ1MEM-16GBSD, L1MEM-2GBSD and L1MEM-4GBSD), FX3 extension modules, terminal modules and I/O cables (FX-16E-500CAB-S, FX-16E-□CAB and FX-16E-□CAB-R)
- *3: The specifications are different in the use at less than 0°C. For details, refer to the manual of each product.
- *4: When used in a low-temperature environment, use in an environment with no sudden temperature changes. If there are sudden temperature changes because of opening/closing of the control panel or other reasons, condensation may occur, which may cause a fire, fault, or malfunction. Furthermore, use an air conditioner in dehumidifier mode to prevent condensation.
- *5: The criterion is shown in IEC61131-2.
- *6: When the system has equipment which specification values are lower than above mentioned vibration resistance specification values, the vibration resistance specification of the whole system is corresponding to the lower specification.
- *7: For grounding, refer to manuals of each product.
- *8: The PLC cannot be used at a pressure higher than the atmospheric pressure to avoid damage.
- *9: The programmable controller is assumed to be installed in an environment equivalent to indoor.
- *10: This indicates the section of the power supply to which the equipment is assumed to be connected between the public electrical power distribution network and the machinery within premises. Category II applies to equipment for which electrical power is supplied from fixed facilities. The surge voltage withstand level for up to the rated voltage of 300 V is 2500 V.
- *11: This index indicates the degree to which conductive material is generated in the environment in which the equipment is used. Pollution level 2 is when only non-conductive pollution occurs. Temporary conductivity caused by condensation must be expected occasionally.
- *12: Direct installation of FX5UC is not possible.

◇ Power supply specifications

● Power supply specifications (FX5U CPU module, AC power supply type)

Item	Specifications			
	FX5U-32M□/E□	FX5U-64M□/E□	FX5U-80M□/E□	
Rated voltage	100 to 240 V AC			
Allowable supply voltage range	85 to 264 V AC			
Voltage fluctuation range	—			
Frequency rating	50/60 Hz			
Allowable instantaneous power failure time	Operation can be continued upon occurrence of instantaneous power failure for 10 ms or less. If the supply voltage is 200 V AC system, change in the range from 10 to 100 ms can be made by the user program.			
Power fuse	250 V 3.15 A Time-lag Fuse	250 V 5 A Time-lag Fuse		
In-rush current	25 A Max. 5 ms or less/100 V AC 50 A Max. 5 ms or less/200 V AC	30 A Max. 5 ms or less/100 V AC 60 A Max. 5 ms or less/200 V AC		
Power consumption*1	30 W	40 W	45 W	
5 V DC internal power supply capacity*3	900 mA	1100 mA	1100 mA	
24 V DC service power supply*2	Supply capacity when service power supply is used for input circuit of the CPU module*4	400 mA (300 mA)	600 mA (300 mA)	600 mA (300 mA)
	Supply capacity when external power supply is used for input circuit of the CPU module*4	480 mA (380 mA)	740 mA (440 mA)	770 mA (470 mA)

- *1: The values show the state where the service power of 24 V DC is consumed to the maximum level in case that its configuration has the max. no. of connections provided to CPU module. (Including the current in an input circuit)
- *2: When I/O modules are connected, they consume current from the 24 V DC service power supply, resulting in decrease of usable current. For details about the service power supply, refer to the manual.
- *3: The values designate power supply capacity for an intelligent function module, expansion adapter, and expansion board.
- *4: The values in the parentheses () will result when the ambient temperature is less than 0°C during operations.

General, power supply, input/output specifications

● Power supply specifications (FX5U CPU module, DC power supply type)

Item	Specifications		
	FX5U-32M□/D□	FX5U-64M□/D□	FX5U-80M□/D□
Rated voltage	24 V DC		
Allowable supply voltage range	16.8 to 28.8 V DC		
Allowable instantaneous power failure time	Operation can be continued upon occurrence of instantaneous power failure for 5 ms or less.		
Power fuse	250 V 3.15 A Time-lag Fuse	250 V 5 A Time-lag Fuse	
In-rush current	50 A Max. 0.5 ms or less/24 V DC	65 A Max. 20 ms or less/24 V DC	
Power consumption*1	30 W	40 W	45 W
5 V DC internal power supply capacity*2 *3	900 mA (775 mA)	1100 mA (975 mA)*2	1100 mA (975 mA)*2
24 V DC internal power supply capacity*2	480 mA (360 mA)	740 mA (530 mA)*2	770 mA (560 mA)*2

*1: The values show the state where power is consumed to the maximum level in case that the configuration has the max. no. of connections provided to CPU module.

*2: The values in the parentheses () indicate the power supply capacity to be resulted when the power supply voltage falls in the range from 16.8 to 19.2 V DC.

*3: The values designate power supply capacity for an intelligent function module, expansion adapter, and expansion board.

● Power supply specifications (FX5UC CPU module)

Item	Specifications		
	FX5UC-32M□/□	FX5UC-64MT/□	FX5UC-96MT/□
Rated voltage	24 V DC		
Allowable supply voltage range	+20%, -15%		
Allowable instantaneous power failure time	Operation can be continued upon occurrence of instantaneous power failure for 5 ms or less.		
Power fuse	125 V 3.15 A Time-lag Fuse		
In-rush current	35 A Max. 0.5 ms or less/24 V DC	40 A Max. 0.5 ms or less/24 V DC	
Power consumption*	5 W/24 V DC (30 W/24 V DC +20%, -15%)	8 W/24 V DC (33 W/24 V DC +20%, -15%)	11 W/24 V DC (36 W/24 V DC +20%, -15%)
5 V DC internal power supply capacity	720 mA		
24 V DC internal power supply capacity	500 mA		

*: The value results when the CPU module is used alone.

The values in the parentheses () result when the maximum no. of connections have been made to the CPU module. (External DC 24 V power supplies of extension modules are not included.)

● Power supply specifications (FX5-4AD-ADP)

Item	Specifications
Internal power feed (A/D conversion circuit)	24 V DC 20 mA Power is internally fed from the 24 V DC power supply of the CPU module.
Internal power feed (interface)	5 V DC 10 mA Power is internally fed from the 5 V DC power supply of the CPU module.

● Power supply specifications (FX5-4DA-ADP)

Item	Specifications
External power feed (D/A conversion circuit)	24 V DC +20%, -15% 160 mA Power is externally fed from the power supply connector of the adapter.
Internal power feed (interface)	5 V DC 10 mA Power is internally fed from the 5 V DC power supply of the CPU module.

● Power Supply Specifications (FX5-4AD-PT-ADP)

Item	Specifications
Internal power feed (A/D conversion circuit)	24 V DC 20 mA Power is internally fed from 24 V DC power supply of the CPU module.
Internal power feed (interface)	5 V DC 10 mA Power is internally fed from 5 V DC power supply of the CPU module.

● Power Supply Specifications (FX5-4AD-TC-ADP)

Item	Specifications
Internal power feed (A/D conversion circuit)	24 V DC 20 mA Power is internally fed from 24 V DC power supply of the CPU module.
Internal power feed (interface)	5 V DC 10 mA Power is internally fed from 5 V DC power supply of the CPU module.

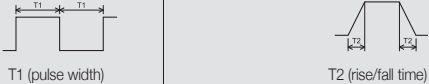
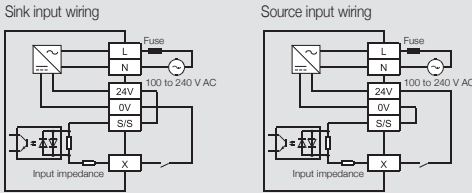
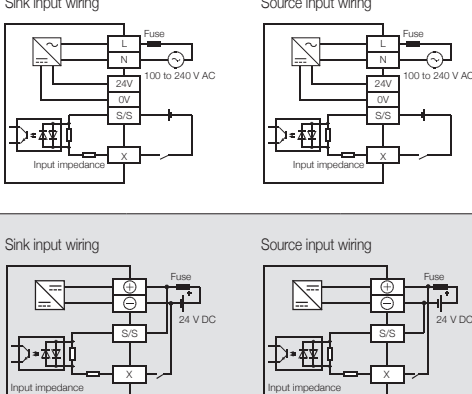

◇ Input specifications

● Input specifications (FX5U CPU module)

Item	Specifications		
	FX5U-32M□	FX5U-64M□	FX5U-80M□
No. of input points	16 points	32 points	40 points
Connection type	Removable terminal block (M3 screws)		
Input type	Sink/source		
Input signal voltage	24 V DC +20%, -15%		
Input signal current	X0 to X17	5.3 mA/24 V DC	
	X20 and subsequent	4.0 mA/24 V DC	
Input impedance	X0 to X17	4.3 kΩ	
	X20 and subsequent	5.6 kΩ	
ON input sensitive current	X0 to X17	3.5 mA or more	
	X20 and subsequent	3.0 mA or more	
OFF input sensitivity current	1.5 mA or less		
Input response frequency	X0 to X5	200 kHz	—
	X0 to X7	—	200 kHz
	X6 to X17	10 kHz	—
	X10 to X17	—	10 kHz
Pulse waveform	Waveform		
	X0 to X5	T1: 2.5 μs or more, T2: 1.25 μs or less	—
	X0 to X7	—	T1: 2.5 μs or more, T2: 1.25 μs or less
	X6 to X17	T1: 50 μs or more, T2: 25 μs or less	—
	X10 to X17	—	T1: 50 μs or more, T2: 25 μs or less
Input response time (H/W filter delay)	X0 to X5	ON: 2.5 μs or less, OFF: 2.5 μs or less	—
	X0 to X7	—	ON: 2.5 μs or less, OFF: 2.5 μs or less
	X6 to X17	ON: 30 μs or less, OFF: 50 μs or less	—
	X10 to X17	—	ON: 30 μs or less, OFF: 50 μs or less
	X20 and subsequent	—	ON: 50 μs or less, OFF: 150 μs or less
Input response time (Digital filter setting value)	None, 10 μs, 50 μs, 0.1 ms, 0.2 ms, 0.4 ms, 0.6 ms, 1 ms, 5 ms, 10 ms (initial values), 20 ms, 70 ms When using this product in an environment with much noise, set the digital filter.		
Input signal format	No-voltage contact input Sink: NPN open collector transistor Source: PNP open collector transistor		
Input circuit isolation	Photo-coupler isolation		
Input operation display	LED is lit when input is on		
Input circuit configuration	AC power supply type	- When using 24 V DC service power supply	
			
	DC power supply type	- When using external power supply	
			

General, power supply, input/output specifications

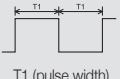
● Input specifications (FX5UC CPU module)

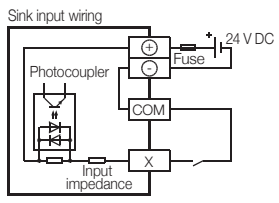
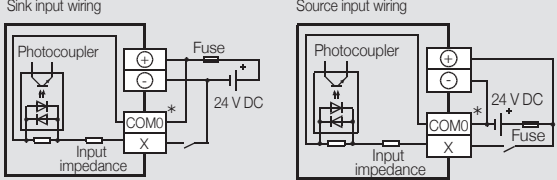
Item	Specifications		
	FX5UC-32M□/□	FX5UC-64MT/□	FX5UC-96MT/□
No. of input points	16 points	32 points	48 points
Connection type	Connector (FX5UC-□MT/D(SS)) Spring clamp terminal block (FX5UC-32M□/□-TS)		
Input type	Sink (FX5UC-□MT/D) Sink/source (FX5UC-□MT/DSS, FX5UC-32MT/DS(S)-TS)		
Input signal voltage	24 V DC +20%, -15%		
Input signal current	X0 to X17	5.3 mA/24 V DC	
	X20 and subsequent	4.0 mA/24 V DC	
Input impedance	X0 to X17	4.3 kΩ	
	X20 and subsequent	5.6 kΩ	
ON input sensitivity current	X0 to X17	3.5 mA or more	
	X20 and subsequent	3.0 mA or more	
OFF input sensitivity current	1.5 mA or less		
Input response frequency	X0 to X5	200 kHz	—
	X0 to X7	—	200 kHz
	X6 to X17	10 kHz	—
	X10 to X17	—	10 kHz
Pulse waveform	Waveform		
	X0 to X5	T1: 2.5 μs or more, T2: 1.25 μs or less	—
	X0 to X7	—	T1: 2.5 μs or more, T2: 1.25 μs or less
	X6 to X17	T1: 50 μs or more, T2: 25 μs or less	—
Input response time (H/W filter delay)	X0 to X5	ON: 2.5 μs or less, OFF: 2.5 μs or less	—
	X0 to X7	—	ON: 2.5 μs or less, OFF: 2.5 μs or less
	X6 to X17	ON: 30 μs or less, OFF: 50 μs or less	—
	X10 to X17	—	ON: 30 μs or less, OFF: 50 μs or less
X20 and subsequent	—	ON: 50 μs or less, OFF: 150 μs or less	
Input response time (Digital filter setting value)	None, 10 μs, 50 μs, 0.1 ms, 0.2 ms, 0.4 ms, 0.6 ms, 1 ms, 5 ms, 10 ms (initial values), 20 ms, 70 ms When using this product in an environment with much noise, set the digital filter.		
Input signal format (Input sensor form)	FX5UC-□MT/D No-voltage contact input NPN open collector transistor FX5UC-□MT/DSS, FX5UC-32M□/□-TS No-voltage contact input Sink: NPN open collector transistor Source: PNP open collector transistor		
Input circuit isolation	Photo-coupler isolation		
Input operation display	LED is lit when input is on (DISP switch: IN)		
Input circuit configuration	<p>FX5UC-□MT/D</p>  <p>FX5UC-□MT/DSS, FX5UC-32M□/□-TS</p> 		

*: Spring clamp terminal block type: The [COM0] terminal is the [S/S] terminal.

General, power supply, input/output specifications

● Input specifications (Extension module (extension connector type), input, input/output module)

Item	Specifications						
	FX5-C16EX/D	FX5-C32EX/D	FX5-C32ET/D	FX5-C16EX/DS	FX5-C32EX/DS	FX5-C32ET/DSS	FX5-C32EX/DS-TS, FX5-C32ET/DS(S)-TS
Connection type	Connector						Spring clamp terminal block
Input type	Sink			Sink/source			
Input signal voltage	24 V DC +20%, -15%						
Input signal current	4.0 mA/24 V DC						
Input impedance	5.6 kΩ						
Input sensitivity current	ON: 3.0 mA or more						
	OFF: 1.5 mA or less						
Input response time	ON: 50 μs or less OFF: 150 μs or less						
Input signal format	No-voltage contact input Sink: NPN open collector transistor			No-voltage contact input Sink: NPN open collector transistor Source: PNP open collector transistor			
Input circuit isolation	Photo-coupler isolation						
Input operation display	LED is lit when input is on.	LED is lit when input is on. (F/L of DISP switch is used to change between lower and higher numbers.)	LED is lit when input is on. (DISP switch: IN)	LED is lit when input is on.	LED is lit when input is on. (F/L of DISP switch is used to change between lower and higher numbers.)	LED is lit when input is on. (DISP switch: IN)	LED is lit when input is on.
Input circuit configuration							

● Input specifications (Extension module (extension cable type), input, input/output module)

Item	Specifications					
	FX5-8EX/ES	FX5-16EX/ES	FX5-16ER/ES	FX5-16ET/ES	FX5-16ET/ESS	FX5-16ET/ES-H FX5-16ET/ESS-H
Connection type	Screw terminal block					
Input type	Sink/source					
Input signal voltage	24 V DC +20%, -15%					
Input signal current	4.0 mA/24 V DC				5.3 mA/24 V DC	
Input impedance	5.6 kΩ				4.3 kΩ	
Input sensitivity current	ON: 3.0 mA or more				3.5 mA or more	
	OFF: 1.5 mA or less					
Input response time	ON: 50 μs or less OFF: 150 μs or less				X0 to 5 ON: 2.5 μs or less OFF: 2.5 μs or less X6, 7 ON: 30 μs or less OFF: 50 μs or less	
Input signal format	No-voltage contact input Sink: NPN open collector transistor Source: PNP open collector transistor					
Input circuit isolation	Photo-coupler isolation					
Input operation display	LED is lit when input is on.					
Input circuit configuration	<p>When using service power supply</p> <p>Source input wiring</p>			<p>When using external power supply</p> <p>Source input wiring</p>		

General, power supply, input/output specifications

● Input specifications (Extension module powered input/output module)

Item	Specifications					
	FX5-32ER/ES	FX5-32ET/ES	FX5-32ET/ESS	FX5-32ER/DS	FX5-32ET/DS	FX5-32ET/DSS
Connection type	Screw terminal block					
Input type	Sink/source					
Input signal voltage	24 V DC +20%, -15%					
Input signal current	4.0 mA/24 V DC					
Input impedance	5.6 kΩ					
Input sensitivity current	ON	3.0 mA or more				
	OFF	1.5 mA or less				
Input response time	ON: 50 μs or less OFF: 150 μs or less					
Input signal format	No-voltage contact input Sink: NPN open collector transistor Source: PNP open collector transistor					
Input circuit isolation	Photo-coupler isolation					
Input operation display	LED is lit when input is on.					
Input circuit configuration	When using service power supply			Sink input wiring		
				Source input wiring		
	When using external power supply			Sink input wiring		
				Source input wiring		

◇ Output specifications

● Relay output (FX5U CPU module)

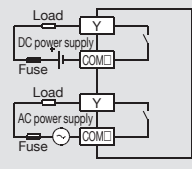
Item	Specifications		
	FX5U-32MR/□	FX5U-64MR/□	FX5U-80MR/□
No. of output points	16 points	32 points	40 points
Connection type	Removable terminal block (M3 screws)		
Output type	Relay		
External power supply	30 V DC or less 240 V AC or less ("250 V AC or less" if not a CE, UL, cUL compliant item)		
Max. load	2 A/point The total load current per common terminal should be the following value. · 4 output points/common terminal: 8 A or less · 8 output points/common terminal: 8 A or less		
Min. load	5 V DC, 2 mA (reference values)		
Open circuit leakage current	-		
Response time	OFF→ON	Approx. 10 ms	
	ON→OFF	Approx. 10 ms	
Isolation of circuit	Mechanical isolation		
Indication of output operation	LED is lit when output is on		
Output circuit configuration			
	A number is entered in the □ of [COM□].		

● Relay output (FX5UC CPU module)

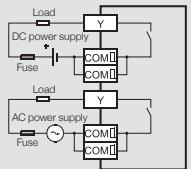
Items	Specifications	
	FX5UC-32MR/DS-TS	
No. of output points	16 points	
Connection type	Spring clamp terminal block	
Output type	Relay	
External power supply	30 V DC or less 240 V AC or less ("250 V AC or less" if not a CE, UL, cUL compliant item)	
Max. load	2 A/point The total load current per common terminal should be the following value. · 8 output points/common terminal: 4 A* or less	
Min. load	5 V DC, 2 mA (reference values)	
Open circuit leakage current	-	
Response time	OFF→ON	Approx. 10 ms
	ON→OFF	Approx. 10 ms
Isolation of circuit	Mechanical isolation	
Indication of output operation	LED is lit when output is on	
Output circuit configuration		
	A number is entered in the □ of [COM□].	

*: 8 A or less when two common terminals are connected to the external part.

● Transistor output (FX5U CPU module)

Item	Specifications		
	FX5U-32MT/□	FX5U-64MT/□	FX5U-80MT/□
No. of output points	16 points	32 points	40 points
Connection type	Screw terminal block		
Output type	Transistor/sink output (FX5U-□MT/ES, FX5U-□MT/DS) Transistor/source output (FX5U-□MT/ESS, FX5U-□MT/DSS)		
External power supply	5 to 30 V DC		
Max. load	0.5 A/point The total load current per common terminal should be the following value. · 4 output points/common terminal: 0.8 A or less · 8 output points/common terminal: 1.6 A or less		
Open circuit leakage current	0.1 mA or less/30 V DC		
Voltage drop when ON	Y0 to Y3	1.0 V or less	
	Y4 and subsequent	1.5 V or less	
Response time	Y0 to Y3	2.5 μs or less/10 mA or more (5 to 24 V DC)	
	Y4 and subsequent	0.2 ms or less/200 mA or more (24 V DC)	
Isolation of circuit	Photo-coupler isolation		
Indication of output operation	LED is lit when output is on		
Output circuit configuration	Sink output wiring		Source output wiring
A number is entered in the □ of [COM□]. A number is entered in the □ of [+V□].			

● Transistor output (FX5UC CPU module)

Item	Specifications		
	FX5UC-32MT/□	FX5UC-64MT/□	FX5UC-96MT/□
No. of output points	16 points	32 points	48 points
Connection type	Connector (FX5UC-□MT/D(SS)) Spring clamp terminal block (FX5UC-32MT/DS(S)-TS)		
Output type	Transistor/sink output (FX5UC-□MT/D(S)-TS) Transistor/source output (FX5UC-□MT/DSS(+)-TS)		
External power supply	5 to 30 V DC		
Max. load	Y000 to Y003: 0.3 A/1 point Y004 and subsequent: 0.1 A/1 point The total load current per common terminal should be the following value. · 8 output points/common terminal: 0.8 A or less*		
Open circuit leakage current	0.1 mA or less/30 V DC		
Voltage drop when ON	Y0 to Y3	1.0 V or less	
	Y4 and subsequent	1.5 V or less	
Response time	Y0 to Y3	2.5 μs or less/10 mA or more (5 to 24 V DC)	
	Y4 and subsequent	0.2 ms or less/100 mA (24 V DC)	
Isolation of circuit	Photo-coupler isolation		
Indication of output operation	LED is lit when output is on (DISP switch: OUT) (FX5UC-□MT/D(SS)) LED is lit when output is on (FX5UC-32MT/DS(S)-TS)		
Output circuit configuration	Sink output wiring		Source output wiring
A number is entered in the □ of [COM□]. A number is entered in the □ of [+V□].			

*: 1.6 A or less when two common terminals are connected outside.

General, power supply, input/output specifications

● Transistor output (sink output, extension module)

Item	Specifications										
	FX5-C16EYT/D	FX5-C32EYT/D	FX5-C32ET/D	FX5-C32EYT/D-TS	FX5-C32ET/DS-TS	FX5-8EYT/ES	FX5-16EYT/ES	FX5-16ET/ES	FX5-32ET/ES	FX5-32ET/DS	FX5-16ET/ES-H
Connection type	Connector			Spring clamp terminal block		Screw terminal block					
Output type	Transistor output/sink output										
External power supply	5 to 30 V DC										
Max. load	0.1 A/1 point The total load current per common terminal should be the following value. · 8 output points/common terminal: 0.8 A or less					0.5 A/1 point The total load current per common terminal should be the following value. · 4 output points/common terminal: 0.8 A or less · 8 output points/common terminal: 1.6 A or less					
Open circuit leakage current	0.1 mA/30 V DC										
Voltage drop when ON	1.5 V or less										
Response time	OFF→ON	0.2 ms or less/100 mA (at 24 V DC)				0.2 ms or less/200 mA (at 24 V DC)					Y0, Y1, Y4, Y5: 2.5 μs or less/10 mA (at 5 to 24 V DC) Y2, Y3, Y6, Y7: 0.2 ms or less/200 mA (at 24 V DC)
	ON→OFF	0.2 ms or less/100 mA (at 24 V DC)				0.2 ms or less/200 mA (at 24 V DC)					
Isolation of circuit	Photo-coupler isolation										
Isolation of output operation	LED is lit when output is on.	LED is lit when output is on. (F/L of DISP switch is used to change between lower and higher numbers.)	LED is lit when output is on. (DISP switch: OUT)	LED is lit when output is on.		LED is lit when output is on.					
Output circuit configuration											

General, power supply, input/output specifications

● Transistor output (source output, extension module)

Item	Specifications											
	FX5-C16EYT/ DSS	FX5-C32EYT/ DSS	FX5-C32ET/ DSS	FX5-C32EYT/ DSS-TS	FX5-C32ET/ DSS-TS	FX5-8EYT/ ESS	FX5-16EYT/ ESS	FX5-16ET/ ESS	FX5-32ET/ ESS	FX5-32ET/ DSS	FX5-16ET/ ESS-H	
Connection type	Connector			Spring clamp terminal block		Screw terminal block						
Output type	Transistor output/sink output											
External power supply	5 to 30 V DC											
Max. load	0.1 A/1 point The total load current per common terminal should be the following value. · 8 output points/common terminal: 0.8 A or less					0.5 A/1 point The total load current per common terminal should be the following value. · 4 output points/common terminal: 0.8 A or less · 8 output points/common terminal: 1.6 A or less						
Open circuit leakage current	0.1 mA/30 V DC											
Voltage drop when ON	1.5 V or less											
Response time	OFF→ON	0.2 ms or less/100 mA (at 24 V DC)				0.2 ms or less/200 mA (at 24 V DC)				Y0, Y1, Y4, Y5: 2.5 μs or less/10 mA (at 5 to 24 V DC) Y2, Y3, Y6, Y7: 0.2 ms or less/ 200 mA (at 24 V DC)		
	ON→OFF	0.2 ms or less/100 mA (at 24 V DC)				0.2 ms or less/200 mA (at 24 V DC)				Y0, Y1, Y4, Y5: 2.5 μs or less/10 mA (at 5 to 24 V DC) Y2, Y3, Y6, Y7: 0.2 ms or less/ 200 mA (at 24 V DC)		
Isolation of circuit	Photo-coupler isolation											
Indication of output operation	LED is lit when output is on.	LED is lit when output is on. (F/L of DISP switch is used to change between lower and higher numbers.)	LED is lit when output is on. (DISP switch: OUT)	LED is lit when output is on.			LED is lit when output is on.					
Output circuit configuration												

General, power supply, input/output specifications

● Relay output (extension module)

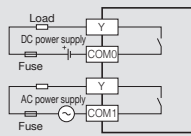
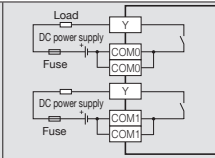
Item	Specifications					
	FX5-8EYR/ES	FX5-16EYR/ES	FX5-16ER/ES	FX5-32ER/ES	FX5-32ER/DS	FX5-C16EYR/D-TS
Connection type	Screw terminal block					Spring clamp terminal block
Output type	Relay					
External power supply	30 V DC or less 240 V AC or less ("250 V AC or less" if not a CE, UL, cUL compliant item)					
Max. load	2 A/1 point The total load current per common terminal should be the following value. · 4 output points/common terminal: 8 A or less · 8 output points/common terminal: 8 A or less					2 A/1 point The total load current per common terminal should be the following value. · 8 output points/common terminal: 4 A or less*
Min. load	5 V DC, 2 mA (reference values)					
Response time	OFF→ON	Approx. 10 ms				
	ON→OFF	Approx. 10 ms				
Isolation of circuit	Mechanical isolation					
Indication of output operation	LED is lit when output is on.					
Output circuit configuration						

● Built-in analog input

Item	Specifications	
	FX5U CPU module	
Analog input points	2 points (2 channels)	
Analog input	Voltage	0 to 10 V DC (input resistance 115.7 kΩ)
Digital output	Unsigned 12-bit binary	
Device allocation	SD6020 (Input data of ch1) SD6060 (Input data of ch2)	
Input characteristics, maximum resolution	Digital output value	0 to 4000
	Maximum resolution	2.5 mV
Precision (Accuracy in respect to full-scale digital output value)	Ambient temperature 25±5°C (77±41°F)	Within ±0.5% (±20 digit*)
	Ambient temperature 0 to 55°C (32±131°F)	Within ±1.0% (±40 digit*)
	Ambient temperature -20 to 0°C (32±131°F)*1	Within ±1.5% (±60 digit*)
Conversion speed	30 μs/channels (data refreshed every operation cycle)	
Absolute maximum input	-0.5 V, +15 V	
Isolation	No isolation from the CPU module internal circuit, no isolation between the input terminals (channels)	
Number of occupied input/output points	0 points (No concern with the maximum no. of input/output points of the CPU module)	
Terminal block used	European-type terminal block	

*1: Products manufactured earlier than June 2016 do not support this specification.

*2: The term "digit" refers to "digital value".

● Built-in analog output

Item	Specifications	
	FX5U CPU module	
Analog output points	1 point (1 channel)	
Digital input	Unsigned 12-bit binary	
Analog output	Voltage	0 to 10 V DC (external load resistance 2 kΩ to 1 MΩ)
Device allocation	SD6180 (Output setting data of ch1)	
Output characteristics, maximum resolution*1	Digital input value	0 to 4000
	Maximum resolution	2.5 mV
Accuracy*2 (Accuracy in respect to full-scale analog output value)	Ambient temperature 25±5°C (77±41°F)	Within ±0.5% (±20 digit*)
	Ambient temperature 0 to 55°C (32±131°F)	Within ±1.0% (±40 digit*)
	Ambient temperature -20 to 0°C (32±131°F)*3	Within ±1.5% (±60 digit*)
Conversion speed	30 μs (data refreshed every operation cycle)	
Isolation	No isolation from the CPU module internal circuit	
Number of occupied input/output points	0 points (No concern with the maximum no. of input/output points of the CPU module)	
Terminal block used	European-type terminal block	

*1: There is a dead band near 0 V output, which is an area where some analog output values do not reflect digital input values.

*2: External load resistance is set to 2 kΩ when shipped from the factory. Thus, output voltage will increase somewhat if the resistance is set higher than 2 kΩ. When the resistance is 1 MΩ, output voltage increases maximum 2%.

*3: Products manufactured earlier than June 2016 do not support this specification.

*4: The term "digit" refers to "digital value".

● Built-in RS-485 communication

Item	Specifications	
	FX6U / FX6UC CPU module	
Transmission standards	Conforms to RS-485/RS-422 specifications	
Data transmission speed	Max. 115.2 kbps	
Communication method	Full-duplex (FDX) / Half-duplex (HDX)	
Maximum transmission distance	50 m	
Protocol type	MELSOFT connection, MC protocol (1C/3C/4C frames), non-protocol communication, MODBUS RTU communication, inverter communication, N:N network, parallel link, communication protocol support	
Isolation of circuit	Not isolated	
Terminal resistors	Built-in (OPEN/110 Ω/330 Ω)	
Terminal block used	European-type terminal block	

● Built-in Ethernet communication

Item	Specifications	
	FX5U / FX5UC CPU module	
Data transmission speed	100/10 Mbps	
Communication method	Full-duplex (FDX) / Half-duplex (HDX)*1	
Interface	RJ45 connector	
Transmission method	Base band	
Maximum segment length (The distance between hub and node)	100 m	
Cascade connection	100BASE-TX	Cascade connection max. 2 stages*2
	10BASE-T	Cascade connection max. 4 stages*2
Protocol type	CC-Link IE Field Network Basic, MELSOFT connection, SLMP (3E frame), socket communication, communication protocol support, FTP server, MODBUS/TCP communication, SNMP client, Web server (HTTP), simple CPU communication function	
Number of connections	Total 8 connections*3 *4 (Up to 8 external devices can access one CPU module at the same time.)	
Hub*1	Hubs with 100BASE-TX or 10BASE-T ports are available.	
IP address*5	Initial value: 192.168.3.250	
Isolation of circuit	Pulse transformer isolation	
Cable used*6	For 100BASE-TX connection	Ethernet standard-compatible cable, category 5 or higher (STP cable)
	For 10BASE-T connection	Ethernet standard-compatible cable, category 3 or higher (STP cable)

*1: IEEE802.3x flow control is not supported.

*2: Number of stages that can be connected when a repeater hub is used. When a switching hub is used, check the specifications of the switching hub used.

*3: One device connected to MELSOFT is not included in the number of connections. (The second and subsequent devices are included.)

*4: The CC-Link IE Field Network Basic, FTP server, SNMP client, Web server and simple CPU communication function are not included in the number of connections.

*5: If the 1st octet is 0 or 127, a parameter error (2222H) will result. (Example: 0.0.0.0, 127.0.0.0 etc.)

*6: A straight cable can be used. If a personal computer or GOT and CPU module are directly connected a cross cable can be used.

● Built-in positioning function

Item	Specifications	
	FX5U / FX5UC CPU module	
Number of control axes	4 axes* (Simple linear interpolation by 2-axis simultaneous start)	
Maximum frequency	2147483647 (200 kpps in pulses)	
Positioning program	Sequence program, Table operation	
Pulse output instruction	PLSY and DPLSY instructions	
Positioning instruction	DSZR, DDSZR, DVIT, DDVIT, TBL, DRVTBL, DRVMUL, DABS, PLSV, DPLSV, DRVI, DDRVI, DRVA, and DDRVA instructions	

*: The number of control axes is 2 when the pulse output mode is CW/CCW mode.

● Built-in high speed counter function

Item	Specifications	
	FX5U / FX5UC CPU module	
Types of high-speed counters	Input specifications	Maximum frequency
	1 phase, 1 input counter (S/W)	200 kHz
	1 phase, 1 input counter (H/W)	200 kHz
	1 phase, 2 input counter	200 kHz
	2 phase, 2 input counter [1 edge count]	200 kHz
	2 phase, 2 input counter [2 edge count]	100 kHz
	2 phase, 2 input counter [4 edge count]	50 kHz
Input allocation	Parameter setup*	
High-speed counter instruction	[High-speed processing instruction] - Setting 32-bit data comparison (DHSCS) - Resetting 32-bit data comparison (DHSCR) - Comparison of 32-bit data band (DHSZ) - Start/stop of the 16-bit data high-speed I/O function (HIOEN) - Start/stop of the 32-bit data high-speed I/O function (DHIOEN)	
	[High-speed transfer instruction of current value] - High-speed current value transfer of 16-bit data (HCMOV) - High-speed current value transfer of 32-bit data (DHCMOV)	

*: For details, refer to manuals of each product.

General, power supply, input/output specifications

◇ Extension Device Specifications I/O Modules

● Powered input/output modules

Model	Total No. of points	No. of input/output points & Input/output type			Connection type	
		Input		Output		
FX5-32ER/ES	32 points	16 points	24 V DC (Sink/source)	16 points	Relay	Screw terminal block
FX5-32ET/ES				Transistor (Sink)		
FX5-32ET/ESS				Transistor (Source)		
FX5-32ER/DS				Relay		
FX5-32ET/DS				Transistor (Sink)		
FX5-32ET/DSS				Transistor (Source)		

● Input module

Model	Total No. of points	No. of input/output points & Input/output type			Connection type
		Input		Output	
FX5-8EX/ES	8 points	8 points	24 V DC (Sink/source)	—	Screw terminal block
FX5-16EX/ES	16 points	16 points	24 V DC (Sink)	—	Connector
FX5-C16EX/D			24 V DC (Sink/source)		
FX5-C16EX/DS	32 points	32 points	24 V DC (Sink)	—	Spring clamp terminal block
FX5-C32EX/D			24 V DC (Sink)		
FX5-C32EX/DS			24 V DC (Sink/source)		
FX5-C32EX/DS-TS					

● Output module

Model	Total No. of points	No. of input/output points & Input/output type			Connection type	
		Input		Output		
FX5-8EYR/ES	8 points	—	—	8 points	Relay	Screw terminal block
FX5-8EYT/ES				Transistor (Sink)		
FX5-8EYT/ESS				Transistor (Source)		
FX5-16EYR/ES	16 points	—	—	16 points	Relay	Connector
FX5-16EYT/ES					Transistor (Sink)	
FX5-16EYT/ESS					Transistor (Source)	
FX5-C16EYT/D					Transistor (Sink)	
FX5-C16EYT/DSS	32 points	—	—	32 points	Relay	Spring clamp terminal block
FX5-C16EYR/D-TS					Transistor (Sink)	Spring clamp terminal block
FX5-C32EYT/D					Transistor (Source)	Connector
FX5-C32EYT/D-TS						Spring clamp terminal block
FX5-C32EYT/DSS						Connector
FX5-C32EYT/DSS-TS						Spring clamp terminal block

● I/O module

Model	Total No. of points	No. of input/output points & Input/output type			Connection type	
		Input		Output		
FX5-16ER/ES	16 points	8 points	24 V DC (Sink/source)	8 points	Relay	Screw terminal block
FX5-16ET/ES				Transistor (Sink)		
FX5-16ET/ESS				Transistor (Source)		
FX5-C32ET/D	32 points	16 points	24 V DC (Sink/source)	16 points	24 V DC (Sink)	Connector
FX5-C32ET/DS-TS					Transistor (Sink)	Spring clamp terminal block
FX5-C32ET/DSS					Transistor (Source)	Connector
FX5-C32ET/DSS-TS						

● High-speed pulse input/output module

Model	Total No. of points	No. of input/output points & Input/output type			Connection type	
		Input		Output		
FX5-16ET/ES-H*	16 points	8 points	24 V DC (Sink/source)	8 points	Transistor (Sink)	Screw terminal block
FX5-16ET/ESS-H*				Transistor (Source)		

*: Supported by FX5U/FX5UC CPU modules Ver. 1.030 or later.

◇ Expansion adapter

● FX5-232ADP

Item	Specifications
Transmission standard/ Maximum transmission distance/Isolation	Conforming to RS-232C/15 m/Photo-coupler isolation (Between communication line and CPU module)
External device connection method	9-pin D-sub, male
Communication method	Half-duplex bidirectional/Full-duplex bidirectional
Protocol type	MELSOFT connection, MC protocol (1C/3C/4C frame), non-protocol communication, MODBUS RTU communication, predefined protocol support
Baud rate	300/600/1200/2400/4800/9600/19200/38400/57600/115200 (bps)*
Compatible CPU module	FX5U, FX5UC
Number of occupied input/output points	0 points (no points occupied)
Control power (supplied from CPU module)	5 V DC, 30 mA /24 V DC, 30 mA

*: The communication method and baud rate vary depending on the type of communication.

● FX5-485ADP

Item	Specifications
Transmission standard/ Maximum transmission distance/Isolation	Conforming to RS-485, RS-422/1200 m/Photo-coupler isolation (Between communication line and CPU module)
External device connection method	European-type terminal block
Communication method	Half-duplex bidirectional/Full-duplex bidirectional
Protocol type	MELSOFT connection, MC protocol (1C/3C/4C frame), non-protocol communication, MODBUS RTU communication, inverter communication, N:N network, parallel link, predefined protocol support
Baud rate	300/600/1200/2400/4800/9600/19200/38400/57600/115200 (bps)*
Terminal resistors	Built-in (OPEN/110 Ω/330 Ω)
Compatible CPU module	FX5U, FX5UC
Number of occupied input/output points	0 points (no points occupied)
Control power (supplied from CPU module)	5 V DC, 20 mA /24 V DC, 30 mA

*: The communication method and baud rate vary depending on the type of communication.

● FX5-4AD-ADP

Item	Specifications																													
Analog input points	4 points (4 channels)																													
External device connection method	European-type terminal block																													
Analog input voltage	-10 to +10 V DC (input resistance 1 MΩ)																													
Analog input current	-20 to +20 mA DC (input resistance 250 Ω)																													
Digital output value	14-bit binary value																													
Input characteristics, resolution*1	<table border="1"> <thead> <tr> <th></th> <th>Analog input range</th> <th>Digital output value</th> <th>Resolution</th> </tr> </thead> <tbody> <tr> <td rowspan="4">Voltage</td> <td>0 to 10 V</td> <td>0 to 16000</td> <td>625 μV</td> </tr> <tr> <td>0 to 5 V</td> <td>0 to 16000</td> <td>312.5 μV</td> </tr> <tr> <td>1 to 5 V</td> <td>0 to 12800</td> <td>312.5 μV</td> </tr> <tr> <td>-10 to +10 V</td> <td>-8000 to +8000</td> <td>1250 μV</td> </tr> <tr> <td rowspan="3">Current</td> <td>0 to 20 mA</td> <td>0 to 16000</td> <td>1.25 μA</td> </tr> <tr> <td>4 to 20 mA</td> <td>0 to 12800</td> <td>1.25 μA</td> </tr> <tr> <td>-20 to +20 mA</td> <td>-8000 to +8000</td> <td>2.5 μA</td> </tr> </tbody> </table>				Analog input range	Digital output value	Resolution	Voltage	0 to 10 V	0 to 16000	625 μV	0 to 5 V	0 to 16000	312.5 μV	1 to 5 V	0 to 12800	312.5 μV	-10 to +10 V	-8000 to +8000	1250 μV	Current	0 to 20 mA	0 to 16000	1.25 μA	4 to 20 mA	0 to 12800	1.25 μA	-20 to +20 mA	-8000 to +8000	2.5 μA
		Analog input range	Digital output value	Resolution																										
	Voltage	0 to 10 V	0 to 16000	625 μV																										
		0 to 5 V	0 to 16000	312.5 μV																										
		1 to 5 V	0 to 12800	312.5 μV																										
		-10 to +10 V	-8000 to +8000	1250 μV																										
Current	0 to 20 mA	0 to 16000	1.25 μA																											
	4 to 20 mA	0 to 12800	1.25 μA																											
	-20 to +20 mA	-8000 to +8000	2.5 μA																											
Accuracy (Accuracy in respect to full-scale digital output value)	Ambient temperature 25±5°C: within ±0.1% (±16 digit) Ambient temperature 0 to 55°C: within ±0.2% (±32 digit) Ambient temperature -20 to 0°C*2: within ±0.3% (±48 digit)																													
Absolute maximum input	Voltage: ±15 V, Current: ±30 mA																													
Isolation	Between input terminal and PLC: Photocoupler isolation Between input terminal channels: Non-isolation																													
Power supply	24 V DC, 20 mA (internal power supply) 5 V DC, 10 mA (internal power supply)																													
Compatible CPU module	Compatible with FX5U and FX5UC, from their first released products																													
Number of occupied input/output points	0 points (no points occupied)																													

*1: For the input conversion characteristic, refer to manuals of each product.

*2: Products manufactured earlier than June 2016 do not support this specification.

General, power supply, input/output specifications

● FX5-4AD-PT-ADP

Item		Specifications	
Analog input points		4 points (4 channels)	
External device connection method		European-type terminal block	
Usable resistance temperature detector*1		Pt100 Ni100 (DIN 43760 1987)	
Temperature measuring range	Pt100	-200 to 850°C (-328 to 1562°F)	
	Ni100	-60 to 250°C (-76 to 482°F)	
Digital output value		16-bit signed binary value	
Digital output value	Pt100	-2000 to 8500 (-3280 to 1562)	
	Ni100	-600 to 2500 (760 to 4820)	
Accuracy	Ambient temperature 25±5°C	Pt100	±0.8°C
		Ni100	±0.4°C
	Ambient temperature -20 to 55°C	Pt100	±2.4°C
		Ni100	±1.2°C
Resolution		0.1°C (0.1 to 0.2°F)	
Conversion speed*2		About 85 ms/channel	
Isolation		Between input terminal and CPU module: Photocoupler isolation Between input terminal channels: Non-isolation	
Power supply		24 V DC, 20 mA (internal power supply) 5 V DC, 10 mA (internal power supply)	
Compatible CPU module		FX5U, FX5UC: Ver. 1.040 or later	
Number of occupied I/O points		0 point (no occupied points)	

*1: Only 3-wire type resistance temperature detectors can be used.

*2: For details of conversion speeds, refer to the manual.

● FX5-4AD-TC-ADP

Item		Specifications		
Analog input points		4 points (4 channels)		
External device connection method		European-type terminal block		
Usable thermocouple		K, J, T, B, R, S		
Temperature measuring range	K	-200 to 1200°C (-328 to 2192°F)		
	J	-40 to 750°C (-40 to 1382°F)		
	T	-200 to 350°C (-328 to 662°F)		
	B	600 to 1700°C (1112 to 3092°F)		
	R	0 to 1600°C (32 to 2912°F)		
	S	0 to 1600°C (32 to 2912°F)		
Digital output value		16-bit signed binary value		
Digital output value	K	-2000 to 12000 (-3280 to 21920)		
	J	-400 to 7500 (-400 to 13820)		
	T	-2000 to 3500 (-3280 to 6620)		
	B	6000 to 17000 (11120 to 30920)		
	R	0 to 16000 (320 to 29120)		
	S	0 to 16000 (320 to 29120)		
Accuracy*1	Ambient temperature 25±5°C	K	±3.7°C (-100 to 1200°C)*2	±4.9°C (-150 to -100°C)*2
		J	±7.2°C (-200 to -150°C)*2	
		T	±2.8°C	
		T	±3.1°C (0 to 350°C)*2	±4.1°C (-100 to 0°C)*2
		R	±5.0°C (-150 to -100°C)*2	±6.7°C (-200 to -150°C)*2
		S	±3.5°C	
	Ambient temperature -20 to 55°C	K	±3.7°C	
		K	±6.5°C (-100 to 1200°C)*2	±7.5°C (-150 to -100°C)*2
		J	±8.5°C (-200 to -150°C)*2	
		J	±4.5°C	
		T	±4.1°C (0 to 350°C)*2	±5.1°C (-100 to 0°C)*2
		R	±6.0°C (-150 to -100°C)*2	±7.7°C (-200 to -150°C)*2
B	±6.5°C			
R	±6.5°C			
S	±6.5°C			
Resolution		K, J, T B, R, S	0.1°C (0.1 to 0.2°F) 0.1 to 0.3°C (0.1 to 0.6°F)	
Conversion speed*3		About 85 ms/channel		
Isolation		Between input terminal and CPU module: Photocoupler isolation Between input terminal channels: Non-isolation		
Power supply		24 V DC, 20 mA (internal power supply) 5 V DC, 10 mA (internal power supply)		
Compatible CPU module		FX5U, FX5UC: Ver. 1.040 or later		
Number of occupied I/O points		0 point (no occupied points)		

*1: Obtaining sufficient accuracy requires a warm-up of 45 minutes (energization).

*2: Accuracy varies depending on the measured temperature range in ().

*3: For details of conversion speeds, refer to the manual.

General, power supply, input/output specifications

● FX5-4DA-ADP

Item	Specifications			
Analog output points	4 points (4 channels)			
External device connection method	European-type terminal block			
Analog output voltage	-10 to +10 V DC (external load resistance value 1 kΩ to 1 MΩ)			
Analog output current	0 to 20 mA DC (external load resistance value 0 to 500 Ω)			
Digital input	14-bit binary value			
Output characteristics, resolution*1	Analog output range		Resolution	
	Voltage	0 to 10 V	0 to 16000	625 μV
		0 to 5 V	0 to 16000	312.5 μV
		1 to 5 V	0 to 16000	250 μV
		-10 to +10 V	-8000 to +8000	1250 μV
	Current	0 to 20 mA	0 to 16000	1.25 μA
4 to 20 mA		0 to 16000	1 μA	
Accuracy (Accuracy in respect to full-scale analog output value)	Ambient temperature 25±5°C: within ±0.1% (Voltage ±20 mV, Current ±20 μA) Ambient temperature -20 to 55°C*2: within ±0.2% (Voltage ±40 mV, Current ±40 μA)			
Isolation	Between output terminal and PLC: Photocoupler isolation Between output terminal channels: Non-isolation			
Power supply	24 V DC +20%, -15% 160 mA (external power supply) 5 V DC, 10 mA (internal power supply)			
Compatible CPU module	Compatible with FX5U and FX5UC, from their first released products			
Number of occupied input/output points	0 points (no points occupied)			

*1: For details on the output conversion characteristic, refer to manuals of each product.

*2: The ambient temperature specification is 0 to 55°C for products manufactured earlier than June 2016.

◇ Expansion board

Item	Specifications		
	FX5-232-BD	FX5-485-BD	FX5-422-BD-GOT
Transmission standards	Conforming to RS-232C	Conforming to RS-485, RS-422	Conforming to RS-422
Maximum transmission distance	15 m	50 m	According to the specification of the GOT
External device connection method	9-pin D-sub, male	European-type terminal block	8-pin MINI-DIN, female
Isolation	Non-insulation (between communication line and CPU)	Non-insulation (between communication line and CPU)	Non-insulation (between communication line and CPU)
Communication method	Half-duplex bidirectional/full duplex bidirectional*1	Half-duplex bidirectional/full duplex bidirectional*1	Half-duplex bidirectional
Protocol type	MELSOFT connection, MC protocol (1C/3C/4C frame), non-protocol communication, MODBUS RTU communication, predefined protocol support	MELSOFT connection, MC protocol (1C/3C/4C frame), non-protocol communication, MODBUS RTU communication, inverter communication, N:N network, parallel link, predefined protocol support	—
Baud rate	300/600/1200/2400/4800/9600/19200/38400/57600/115200 (bps)*1	300/600/1200/2400/4800/9600/19200/38400/57600/115200 (bps)*1	9600/19200/38400/57600/115200 (bps)
Terminal resistors	—	Built-in (OPEN/110 Ω/330 Ω)	—
Power supply	5 V DC, 20 mA (internal power supply)	5 V DC, 20 mA (internal power supply)	5 V DC, 20 mA (internal power supply)*2
Compatible CPU module	FX5U	FX5U	FX5U
Number of occupied input/output points	0 points (no points occupied)	0 points (no points occupied)	0 points (no points occupied)

*1: The communication method and baud rate vary depending on the type of communication.

*2: When the GOT 5 V type is connected with this product, the power consumption increases. For the current consumption, refer to the manual of the model to be connected.

◇ Extension power supply module

● FX5-1PSU-5V

Item	Specifications	
Rated supply voltage	100 to 240 V AC	
Allowable range of supply voltage	85 to 264 V AC	
Frequency rating	50/60 Hz	
Allowable instantaneous power failure time	Operation can be continued upon occurrence of instantaneous power failure for 10 ms or less.	
Power fuse	250 V, 3.15 A time-lag fuse	
In-rush current	25 A Max. 5 ms or less/100 V AC 50 A Max. 5 ms or less/200 V AC	
Power consumption	20 W Max.	
Output current*	24 V DC	300 mA (Maximum output current depends on the ambient temperature.)
(For power supply to rear stage)	5 V DC	1200 mA (Maximum output current depends on the ambient temperature.)
Compatible CPU module	FX5U (AC power supply type)	
Number of occupied input/output points	0 points (no points occupied)	

*: For details on the current conversion characteristic, refer to manuals of each product.

● FX5-C1PS-5V

Item	Specifications	
Supply voltage	24 V DC	
Voltage fluctuation range	+20%, -15%	
Allowable time of momentary power failure	Operation can be continued upon occurrence of instantaneous power failure for 5 ms or less.	
Power fuse	125 V, 3.15 A time-lag fuse	
In-rush current	35 A Max. 0.5 ms or less/24 V DC	
Power consumption	30 W Max.	
Output current*	24 V DC	625 mA (Maximum output current depends on the ambient temperature.)
(For power supply to rear stage)	5 V DC	1200 mA (Maximum output current depends on the ambient temperature.)
Compatible CPU module	FX5U (DC power supply type) FX5UC	
Number of occupied input/output points	0 points (no points occupied)	

*: For details on the current conversion characteristic, refer to manuals of each product.

General, power supply, input/output specifications

◇ Bus conversion module

● FX5-CNV-BUS (FX5 (extension cable type)—FX3 extension)

Item	Specifications
Compatible CPU module	FX5U, FX5UC
Number of occupied input/output points	8 points (Either input or output is available for counting.)
Control power (supplied from PLC)	5 V DC 150 mA

● FX5-CNV-BUSC (FX5 (extension connector type)—FX3 extension)

Item	Specifications
Compatible CPU module	FX5U, FX5UC
Number of occupied input/output points	8 points (Either input or output is available for counting.)
Control power (supplied from PLC)	5 V DC 150 mA

◇ Connector conversion module

● FX5-CNV-IF (FX5 (extension cable type)—FX5 (extension connector type) extension)

Item	Specifications
Compatible CPU module	FX5U
Number of occupied input/output points	0 points (no points occupied)
Control power (supplied from PLC)	0 mA (no power consumed)

● FX5-CNV-IFC (FX5 (extension connector type)—FX5 (extension cable type) extension)

Item	Specifications
Compatible CPU module	FX5UC
Number of occupied input/output points	0 points (no points occupied)
Control power (supplied from PLC)	0 mA (no power consumed)

◇ Intelligent function module

● FX5-4AD

Items		Specifications		
Analog input points		4 points (4 channels)		
External device connection method		Spring clamp terminal block		
Analog input voltage		-10 to +10 V DC (Input resistance 400 kΩ or more)		
Analog input current		-20 to +20 mA DC (Input resistance 250 Ω)		
Absolute maximum input		Voltage: ±15 V, Current: ±30 mA		
Input characteristics, resolution*1	Voltage	Analog input range	Digital output value	Resolution
		0 to 10 V	0 to 32000	312.5 μV
		0 to 5 V	0 to 32000	156.25 μV
		1 to 5 V	0 to 32000	125 μV
	Current	-10 to +10 V	-32000 to +32000	312.5 μV
		User range setting	-32000 to +32000	125 μV*2
		0 to 20 mA	0 to 32000	625 nA
		4 to 20 mA	0 to 32000	500 nA
Digital output value	Voltage/Current	16-bit signed binary (-32768 to +32767)		
		16-bit signed binary (-32768 to +32767)		
Accuracy	Voltage/Current	Ambient temperature 25±5°C: within ±0.1% (±64 digits)		
		Ambient temperature 0 to 55°C: within ±0.2% (±128 digits)		
		Ambient temperature -20 to 0°C: within ±0.3% (±192 digits)		
Conversion speed		80 μs/ch		
Isolation		Between input terminal and PLC: Photocoupler isolation Between input terminal channels: Non-isolation		
Power supply		24 V DC, 40 mA (internal power supply) 5 V DC, 100 mA (internal power supply)		
Compatible CPU module		FX5U, FX5UC: Ver. 1.050 or later Connection with FX5UC requires FX5-CNV-IFC or FX5-C1PS-5V.		
Number of occupied I/O points		8 points (Either input or output is available for counting.)		

*1: For details on the input characteristics, refer to the manual.

*2: Maximum resolution in the user range setting.

● FX5-4DA

Items		Specifications		
Analog output points		4 points (4 channels)		
External device connection method		Spring clamp terminal block		
Analog output voltage		-10 to +10 V DC (External load resistance 1 kΩ to 1 MΩ)		
Analog output current		0 to 20 mA DC (External load resistance 0 to 500 Ω)		
Output characteristics, resolution*1	Voltage	Analog output range	Digital value	Resolution
		0 to 10 V	0 to 32000	312.5 μV
		0 to 5 V	0 to 32000	156.3 μV
		1 to 5 V	0 to 32000	125 μV
	Current	-10 to +10 V	-32000 to +32000	312.5 μV
		User range setting	-32000 to +32000	312.5 μV*2
		0 to 20 mA	0 to 32000	625 nA
		4 to 20 mA	0 to 32000	500 nA
Digital input	Voltage/Current	16-bit signed binary (-32768 to +32767)		
		16-bit signed binary (-32768 to +32767)		
Accuracy	Voltage/Current	Ambient temperature 25±5°C: within ±0.1% (Voltage ±20 mV, Current ±20 μA)		
		Ambient temperature 0 to 55°C: within ±0.2% (Voltage ±40 mV, Current ±40 μA)		
		Ambient temperature -20 to 0°C: within ±0.3% (Voltage ±60 mV, Current ±60 μA)		
Conversion speed		80 μs/ch		
Isolation		Between output terminal and PLC: Photocoupler isolation Between output channels: Non-isolation		
Power supply		5 V DC, 100 mA (internal power supply) 24 V DC, +20%, -15% 150 mA (external power supply)		
Compatible CPU module		FX5U, FX5UC: Ver. 1.050 or later Connection with FX5UC requires FX5-CNV-IFC or FX5-C1PS-5V.		
Number of occupied I/O points		8 points (Either input or output is available for counting.)		

*1: For details on the output characteristics, refer to the manual.

*2: Maximum resolution in the user range setting.

General, power supply, input/output specifications

● FX5-8AD

Item	Specifications			
Analog input points	8 points (8 channels)			
External device connection method	Spring clamp terminal block			
Analog input voltage	-10 to 10 V DC (input resistance 1 MΩ)			
Analog input current	-20 to +20 mA DC (input resistance 250 Ω)			
Absolute maximum input	Voltage: ±15 V, Current: ±30 mA			
Input characteristics, resolution	Thermocouple	K, J, T: 0.1°C (0.1 to 0.2°F) B, R, S: 0.1 to 0.3°C (0.1 to 0.6°F)		
	Resistance temperature detector	0.1°C (0.2°F)		
	Voltage	Analog input range	Digital output value	Resolution
		0 to 10 V	0 to 32000	312.5 μV
		0 to 5 V	0 to 32000	156.25 μV
		1 to 5 V	0 to 32000	125 μV
Current	-10 to +10 V	-32000 to +32000	312.5 μV	
	0 to 20 mA	0 to 32000	625 nA	
	4 to 20 mA	0 to 32000	500 nA	
	-20 to +20 mA	-32000 to +32000	625 nA	
Digital output value (16-bit signed binary value)	Thermocouple	K: -2000 to +12000 (-3280 to +21920) J: -400 to +7500 (-400 to +13820) T: -2000 to +3500 (-3280 to +6620) B: 6000 to 17000 (11120 to 30920) R: 0 to 16000 (320 to 29120) S: 0 to 16000 (320 to 29120)		
	Resistance temperature detector	Pt100: -2000 to +8500 (-3280 to +15620) Ni100: -600 to +2500 (-760 to +4820)		
	Voltage/Current	16-bit signed binary (-32000 to +32000)		
Accuracy*	Resistance temperature detector	Ambient temperature 25±5°C	Pt100: ±0.8°C Ni100: ±0.4°C	
	Thermocouple	Ambient temperature -20 to 55°C	Pt100: ±2.4°C Ni100: ±1.2°C	
		Ambient temperature 25±5°C	K: ±3.5°C (-200 to -150°C) K: ±2.5°C (-150 to -100°C) K: ±1.5°C (-100 to 1200°C) J: ±1.2°C T: ±3.5°C (-200 to -150°C) T: ±2.5°C (-150 to -100°C) T: ±1.5°C (-100 to 350°C) B: ±2.3°C R: ±2.5°C S: ±2.5°C	
		Ambient temperature -20 to 55°C	K: ±8.5°C (-200 to -150°C) K: ±7.5°C (-150 to -100°C) K: ±6.5°C (-100 to 1200°C) J: ±3.5°C T: ±5.2°C (-200 to -150°C) T: ±4.2°C (-150 to -100°C) T: ±3.1°C (-100 to 350°C) B: ±6.5°C R: ±6.5°C S: ±6.5°C	
	Voltage/Current	Ambient temperature 25±5°C	Within ±0.3% (±192 digits)	
	Ambient temperature -20 to 55°C	Within ±0.5% (±320 digits)		
Conversion speed	Voltage/Current	1 ms/ch		
	Thermocouple/Resistance temperature detector	40 ms/ch		
Isolation	Between input terminal and PLC: Photocoupler isolation Between input terminal channels: Non-isolation			
Power supply	24 V DC, 40 mA (internal power supply) 24 V DC +20%, -15% 100 mA (external power supply)			
Compatible CPU module	FX5U, FX5UC: Ver. 1.050 or later Connection with FX5UC requires FX5-CNV-IFC or FX5-C1PS-5V.			
Number of occupied I/O points	8 points (Either input or output is available for counting.)			

*: To stabilize the accuracy, warm-up (supply power) the system for 30 minutes or more after power-on.

General, power supply, input/output specifications

● FX5-4LC

Item		Specifications		
Control system		Two-position control, standard PID control, heating/cooling PID control, cascade control		
External device connection method		Spring clamp terminal block		
Control operation cycle		250 ms/4 ch		
Temperature measuring range	Thermocouple	K: -200 to +1300°C (-100 to +2400°F) J: -200 to +1200°C (-100 to +2100°F) T: -200 to +400°C (-300 to +700°F) S: 0 to 1700°C (0 to 3200°F) R: 0 to 1700°C (0 to 3200°F) E: -200 to +1000°C (0 to 1800°F) B: 0 to 1800°C (0 to 3000°F) N: 0 to 1300°C (0 to 2300°F) PLI: 0 to 1200°C (0 to 2300°F) W5Re/W26Re: 0 to 2300°C (0 to 3000°F) U: -200 to +600°C (-300 to +700°F) L: 0 to 900°C (0 to 1600°F)		
	Resistance temperature detector	Pt100 (3-wire type): -200 to +600°C (-300 to +1100°F) JPT100 (3-wire type): -200 to +500°C (-300 to +900°F) Pt1000 (2-wire/3-wire type): -200.0 to +650.0°C (-328 to +1184°F)		
	Micro voltage input	0 to 10 mV DC, 0 to 100 mV DC		
Heater disconnection detection		Alarm detection		
Input specifications	Number of input points	4 points		
	Input type	Thermocouple	K, J, R, S, E, T, B, N, PLII, W5Re/W26Re, U, L	
		Resistance temperature detector	3-wire type Pt100 3-wire type JPT100 2-wire/3-wire type Pt1000	
		Micro voltage input		
	Measurement accuracy	Refer to the MELSEC iQ-F FX5 User's Manual (Temperature Control).		
	Cold junction temperature compensation error	Ambient temperature 0 to 55°C	Within ±1.0°C. When the input value is -150 to -100°C: Within ±2.0°C When the input value is -200 to -150°C: Within ±3.0°C	
		Ambient temperature -20 to 0°C	Within ±1.8°C. When the input value is -150 to -100°C: Within ±3.6°C When the input value is -200 to -150°C: Within ±5.4°C	
	Resolution	0.1°C (0.1°F), 1.0°C (1.0°F), 0.5 μV, or 5.0 μV (depends on the input range of the sensor used)		
	Sampling cycle	250 ms/4ch		
	Influence of input conductor resistance (for resistance temperature detector input)	3-wire type	About 0.03%/Ω for full scale, and 10 Ω or less per line	
		2-wire type	About 0.04%/Ω for full scale, and 7.5 Ω or less per line	
	Influence of external resistance (for thermocouple input)	About 0.125 μV/Ω		
Input impedance	1 MΩ or more			
Sensor current	About 0.2 mA (for resistance temperature detector input)			
Operation at input disconnection/short circuit	Upscale/downscale (for resistance temperature detector input)			
Output specifications	Number of points: 4 Type: NPN open collector transistor output, Rated load voltage: 5 to 24 V DC Maximum load current: 100 mA, Control output cycle: 0.5 to 100.0 seconds			
Power supply	5 V DC, 140 mA (internal power supply) 24 V DC +20%, -15% 25 mA (external power supply)			
Isolation	<ul style="list-style-type: none"> The analog input part and between the transistor output part and PLC are insulated by the photocoupler. The analog input part and between the transistor output part and power supply are insulated by the DC-DC converter. Insulated between channels 			
Compatible CPU module	FX5U, FX5UC: Ver. 1.050 or later Connection with FX5UC requires FX5-CNV-IFC or FX5-C1PS-5V.			
Number of occupied I/O points	8 points (Either input or output is available for counting.)			

● FX5-20PG-P, FX5-20PG-D

Item	Specifications	
	FX5-20PG-P	FX5-20PG-D
Number of control axes	2 axes	
Command Speed	200 kpps	5 Mpps
Pulse Output	Output signal: PULSE/SIGN mode, CW/CCW mode, phase A/B (4 multiplication), phase A/B (1 multiplication) Output terminal: Transistor 5 to 24 V DC 50 mA or less	Output signal: PULSE/SIGN mode, CW/CCW mode, phase A/B (4 multiplication), phase A/B (1 multiplication) Output terminal: Differential driver equivalent to AM26C31
External I/O specifications	Input: READY/STOP/FLS/RLS/PG024/DOG/CHG terminals: 24 V DC 5 mA, PULSER A/PULSER B terminals: 5 V DC 14 mA Zero point signal PG05 terminal: 5 V DC 5 mA Output: CLEAR (deviation counter): 5 to 24 V DC 100 mA or less Circuit insulation: Photocoupler insulation	
Power supply	24 V DC +20%, -15% 120 mA (external power supply)	24 V DC +20%, -15% 165 mA (external power supply)
Compatible CPU module	FX5U, FX5UC: Ver. 1.050 or later Connection with FX5UC requires FX5-CNV-IFC or FX5-C1PS-5V.	
Number of occupied I/O points	8 points (Either input or output is available for counting.)	

General, power supply, input/output specifications

● FX5-ENET

Items		Specifications		
CC-Link IE Field Network Basic	Station type	Master station		
	Maximum number of connectable stations*1	32		
	Number of stations occupied by a slave station	1 to 4		
	Maximum number of link points per network	RX	2048 points	
		RY	2048 points	
		RWr	1024 points	
		RWw	1024 points	
	Maximum number of link points per station	Master station	RX	2048 points
			RY	2048 points
			RWr	1024 points
			RWw	1024 points
		Slave station*2	RX	64/128/192/256 points
			RY	64/128/192/256 points
			RWr	32/64/96/128 points
			RWw	32/64/96/128 points
	UDP port number used in the cyclic transmission		61450	
UDP port number used in automatic detection of connected devices		Master station: An unused port number is assigned automatically. Slave station: 61451		
Transmission specifications	Data transfer speed	100 Mbps		
	Maximum station-to-station distance	100 m		
	Overall cable distance	Depends on the system configuration		
	Number of cascade connections	100BASE-TX	When using a switching hub, check the number of cascaded stages with the manufacturer of the hub to be used.	
Network topology		Consult the manufacturer.		
Hub*3		Hubs with 100BASE-TX ports*4 can be used.		
Connection cable*5		100BASE-TX	Ethernet standard-compatible cable Category 5 or higher (STP cable)	
General-purpose Ethernet communication	Transmission specifications	Data transfer speed	100/10 Mbps	
		Communication mode	Full-duplex or half-duplex*3	
		Transmission method	Base band	
		Interface	RJ45 connector	
		Maximum segment length (Maximum distance between hub and node)	100 m*6	
		Number of cascade connections	100BASE-TX	Max. 2 stages*7
		10BASE-T	Max. 4 stages*7	
	Supported protocol		Socket communication	
	Number of connections		Total of 32 connections (Up to 32 external devices can access one FX5-ENET module at the same time.)	
	Hub*3		Hubs with 100BASE-TX or 10BASE-T ports*8 can be used.	
Connection cable*5		100BASE-TX	Ethernet standard-compatible cable Category 5 or higher (STP cable)	
	10BASE-T	Ethernet standard-compatible cable Category 3 or higher (STP/UTP cable)		
Number of ports		2*9		
Power supply		5 V DC, 110 mA (internal power supply)		
Compatible CPU module		FX5U, FX5UC: Ver. 1.110 or later Connection with FX5UC requires FX5-CNV-IFC or FX5-C1PS-5V.		
Number of occupied I/O points		8 points (Either input or output is available for counting.)		

*1: Maximum number of connected slave stations that FX5-ENET (master station) can manage.

*2: Value for 1-station occupation, 2-station occupation, 3-station occupation, or 4-station occupation.

*3: IEEE802.3x flow control is not supported.

*4: The ports must comply with the IEEE802.3 100BASE-TX standards.

*5: A straight/cross cable can be used.

*6: For maximum segment length (length between hubs), consult the manufacturer of the hub used.

*7: This number applies when a repeater hub is used. When using a switching hub, check the number of cascaded stages with the manufacturer of the hub to be used.

*8: The ports must comply with the IEEE802.3 100BASE-TX or IEEE802.3 10BASE-T standards.

*9: Because the IP address is shared by two ports, only one address can be set.

General, power supply, input/output specifications

● FX5-ENET/IP

Items		Specifications	
EtherNet/IP communications	Class 1 communications	Communication format	Standard EtherNet/IP
		Number of connections	32
		Communication data size	1444 bytes (per connection)
		Connection type	Point-to-point, multicast
		RPI (communication cycle)	2 to 60000 ms
		PPS (communication processing performance)	3000 pps (case of 128 bytes)
	Class 3 communications	Communication format	Standard EtherNet/IP
		Number of connections (number of simultaneous executions)	32*1
		Communication data size	1414 bytes (per connection)*2
	UCMM communications	Communication format	Standard EtherNet/IP
		Number of connections (number of simultaneous executions)	32*1
		Communication data size	1414 bytes*2
		Connection type	Point-to-point
	Transmission specifications	Data transmission speed	100 Mbps
		Communication mode	Full-duplex
		Transmission method	Base band
		IP version	IPv4 is supported.
		Maximum segment length	100 m*3
Network topology	Number of cascade connections	100BASE-TX: 2 levels maximum*4	
	Network topology	Star topology, line pology	
Hub*5		*6	
Connection cable*7		100BASE-TX	
General-purpose Ethernet communication	Transmission specifications	Data transfer speed	100/10 Mbps
		Communication mode	Full-duplex or half-duplex*5
		Transmission method	Base band
		Maximum segment length	100 m*3
		Number of cascade connections	100BASE-TX:2 levels maximum*4 10BASE-T:4 levels maximum*4
	Protocol type		Socket communication
	Number of connections		Total of 32 connections*8
	Hub*5		*9
Connection cable*7		100BASE-TX, 10BASE-T	
Number of ports		2*10	
Power supply		24 V DC, 110 mA (internal power supply)	
Compatible CPU module		FX5U, FX5UC: Ver. 1.110 or later Connection with FX5UC requires FX5-CNV-IFC or FX5-C1PS-5V.	
Number of occupied I/O points		8 points (Either input or output is available for counting.)	

- *1 : The total number of connections for Class 3 communications and UCMM communications is 32.
- *2 : This size is the maximum size which can be specified to 'Data length' of Class1 communication input data area of the request command during the client operation. During the sever operation, since the FX5-ENET/IP automatically responds according to the request command received from the client, the maximum size is not prescribed.
- *3 : For maximum segment length (length between hubs), consult the manufacturer of the hub used.
- *4 : This number applies when a repeater hub is used. When using a switching hub, check the number of cascaded stages with the manufacturer of the hub to be used.
- *5 : IEEE802.3x flow control is not supported.
- *6 : Hubs with 100BASE-TX ports can be used. The ports must comply with the IEEE802.3 100BASE-TX standards.
- *7 : A straight/cross cable can be used.
- *8 : Up to 32 external devices can access one FX5-ENET/IP module at the same time.
- *9 : Hubs with 100BASE-TX or 10BASE-T ports can be used. The ports must comply with the IEEE802.3 100BASE-TX or IEEE802.3 10BASE-T standards.
- *10 : Since the IP address is shared by two ports, only one address can be set.

General, power supply, input/output specifications

● FX5-CCL-MS

Item		Specifications									
Compatible functions		Master station or intelligent device station									
CC-Link supported version		Ver. 2.00 and Ver. 1.10									
Transmission Speed		<ul style="list-style-type: none"> Master station: 156 kbps/625 kbps/2.5 Mbps/5 Mbps/10 Mbps Intelligent device station: 156 kbps/625 kbps/2.5 Mbps/5 Mbps/10 Mbps/auto-tracking 									
Station number		<ul style="list-style-type: none"> Master station: 0 Intelligent device station: 1 to 64 									
Connectable station type (at the time of master station)		Remote I/O station, remote device station, and intelligent device station (local station and standby master station cannot be connected)									
Maximum overall cable length		1200 m (varies depending on transmission speed)									
Maximum number of connected stations (at the time of master station)		<ul style="list-style-type: none"> Remote I/O stations: Up to 14 stations (total number of I/O points remote I/O stations is 448 or less) Total of remote device stations + intelligent device stations: Up to 14 stations (total number of inputs/outputs of intelligent device stations and remote device stations is 448 or less) 									
Number of occupied stations (at the time of intelligent device station)		1 to 4 stations (changed according to the setting of engineering tool)									
Maximum number of link points per system*5	CC-Link Ver. 1	Remote I/O (RX, RY): 896 points (remote I/O station: 448 points*3, remote device stations and intelligent device stations: 448 points) <ul style="list-style-type: none"> Remote register (RWw): 56 points Remote register (RWr): 56 points 									
	CC-Link Ver. 2	Remote I/O (RX, RY): 896 (remote I/O station: 448 points*3, remote device stations and intelligent device stations: 448 points) <ul style="list-style-type: none"> Remote register (RWw): 112 points Remote register (RWr): 112 points 									
		CC-Link Ver. 2									
Number of link points*5	Extended cyclic setting	CC-Link Ver. 1		Single		Double		Quadruple		Octuple	
	Number of occupied stations	Remote I/O	Remote register	Remote I/O	Remote register	Remote I/O	Remote register	Remote I/O	Remote register	Remote I/O	Remote register
	1 station occupied	RX, RY: 32 points (16 points)*4	RWw: 4 points RWr: 4 points	RX, RY: 32 points (16 points)*4	RWw: 4 points RWr: 4 points	RX, RY: 32 points (16 points)*4	RWw: 8 points RWr: 8 points	RX, RY: 64 points (48 points)*4	RWw: 16 points RWr: 16 points	RX, RY: 128 points (112 points)*4	RWw: 32 points RWr: 32 points
	2 station occupied	RX, RY: 64 points (48 points)*4	RWw: 8 points RWr: 8 points	RX, RY: 64 points (48 points)*4	RWw: 8 points RWr: 8 points	RX, RY: 96 points (80 points)*4	RWw: 16 points RWr: 16 points	RX, RY: 192 points (176 points)*4	RWw: 32 points RWr: 32 points	RX, RY: 384 points (368 points)*4	RWw: 64 points RWr: 64 points
	3 station occupied	RX, RY: 96 points (80 points)*4	RWw: 12 points RWr: 12 points	RX, RY: 96 points (80 points)*4	RWw: 12 points RWr: 12 points	RX, RY: 160 points (144 points)*4	RWw: 24 points RWr: 24 points	RX, RY: 320 points (304 points)*4	RWw: 48 points RWr: 48 points		
4 station occupied	RX, RY: 128 points (112 points)*4	RWw: 16 points RWr: 16 points	RX, RY: 128 points (112 points)*4	RWw: 16 points RWr: 16 points	RX, RY: 224 points (208 points)*4	RWw: 32 points RWr: 32 points	RX, RY: 448 points (-)*4	RWw, RWr: 64 points (-)*4			
Transmission cable		CC-Link Ver. 1.10 compatible CC-Link dedicated cable									
Compatible CPU module		FX5U, FX5UC Ver. 1.050 or later Connection with FX5UC requires FX5-CNV-IFC or FX5-C1PS-5V.									
Communication method		Broadcast polling method									
Transmission format		HDLC compliant									
Error control system		CRC ($X^{16} + X^2 + X^0 + 1$)									
Power supply		24 V DC +20%, -15% 100 mA (external power supply)									
Number of occupied I/O points		8 points (can be counted on either input or output)									

*1: When using the FX5-CCL-MS as the master station, it cannot be used together with the FX3U-16CCCL-M.

*2: When using the FX5-CCL-MS as the intelligent device station, it cannot be used together with the FX3U-64CCCL.

*3: The number of remote I/O points that can be used per system varies depending on the number of input/output points of the extension device.

For the limit of the number of I/O points, refer to the following manual.

→ MELSEC IQ-F FX5U User's Manual (Hardware)

→ MELSEC IQ-F FX5UC User's Manual (Hardware)

*4: The numbers in parentheses are the points that can be used when the module is an intelligent device station.

*5: Number of links with FX5U/FX5UC CPU module Ver. 1.100 or later. GX Works3 Ver. 1.047Z or later required. For details on the number of links with FX5U/FX5UC CPU module earlier than Ver. 1.100, refer to the following manual.

→ MELSEC IQ-F FX5 User's Manual (CC-Link)

● FX5-CCLIEF

Item		Specifications									
Station type		Intelligent device station									
Station number		1 to 120 (sets by parameter or program)									
Communication speed		1 Gbps									
Network topology		Line topology, star topology (coexistence of line topology and star topology is also possible), and ring topology									
Maximum station-to-station distance		Max. 100 m (Conforming to ANSI/TIA/EIA-568-B (Category 5e))									
Cascade connection		Max. 20 stages									
Communication method		Token passing									
Maximum number of link points*1	RX	384 points, 48 bytes									
	RY	384 points, 48 bytes									
	RWw	1024 points, 2048 bytes*2									
	RWr	1024 points, 2048 bytes*2									
Compatible CPU module		FX5U, FX5UC Ver. 1.030 or later. Connection with FX5UC requires FX5-CNV-IFC or FX5-C1PS-5V.									
Power supply		5 V DC, 10 mA (internal power supply) 24 V DC, 230 mA (external power supply)									
Number of occupied I/O points		8 points (Either input or output is available for counting.)									

*1: The maximum number of link points that a master station can assign to one FX5-CCLIEF module.

*2: 256 points (512 bytes) when the mode of the master station is online (High-Speed Mode).

General, power supply, input/output specifications

● FX5-ASL-M

Item	Specifications
Transmission clock	27.0 kHz
Maximum transmission distance (total extension distance)	200 m*1
Transmission system	DC power supply superimposed total frame/cyclic system
Connection type	Bus type (multi-drop method, T-branch method, tree branch method)
Transmission protocol	Dedicated protocol (AnyWireASLINK)
Error control	Checksum, double check method
Number of connected I/O points	Up to 448 points*2*3 (256 input points maximum/256 output points maximum)
Number of connected slave modules	Up to 128 modules (the number varies depending on the current consumption of each slave module)
External interface	7-piece spring clamp terminal block push-in type
RAS function	<ul style="list-style-type: none"> Transmission line disconnection position detection function Transmission line short-circuit detection function Transmission power drop detection function
Transmission line (DP, DN)	<ul style="list-style-type: none"> UL-compliant general-purpose 2-wire cable UL-compliant general-purpose cable For dedicated flat cables
Power cable (24 V, 0 V)	
Memory	Built-in memory EEPROM (rewrite endurance: 100 thousand times)
Compatible CPU module	FX5U, FX5UC: Ver. 1.050 or later Connection with FX5UC requires FX5-CNV-IFC or FX5-C1PS-5V.
Power supply	5 V DC, 200 mA (internal power supply) 24 V DC +15%, -10% 100 mA (external power supply)
Number of occupied I/O points	8 (can be counted on either input or output)

- *1: For the slave module in which the transmission line (DP, DN) and module body are integrated, the length of the transmission line (DP, DN) is also included in the total extension. When laying a 4-wire (DP, DN, 24 V, 0 V) line for fifty meters or more, insert a power line noise filter between the power supply and the line. For details, refer to the manual of ASLINK filter (ANF-01) made by Anywire Corporation.
- *2: The number of remote I/O points that can be used per system varies depending on the number of input/output points of the extension device. For the limit of the number of I/O points, refer to the following manual.
→ MELSEC iQ-F FX5U User's Manual (Hardware)
→ MELSEC iQ-F FX5UC User's Manual (Hardware)
- *3: Supported by FX5U/FX5UC CPU modules Ver. 1.100 or later and by GX Works3 Ver. 1.047Z or later.

● FX5-DP-M

Items	Specifications	
PROFIBUS-DP station type	Class 1 master station	
Transmission specifications	Electrical standard and characteristics	Compliant with EIA-RS485
	Medium	Shielded twisted pair cable
	Network configuration	Bus topology (or tree topology when repeaters are used)
	Data link method	Between DP-Masters: Token passing Between DP-Master and DP-Slave: Polling
	Encoding method	NRZ
	Transmission speed*1	9.6 kbps, 19.2 kbps, 93.75 kbps, 187.5 kbps, 500 kbps, 1.5 Mbps, 3 Mbps, 6 Mbps, 12 Mbps
	Transmission distance	Differs depending on transmission speed*2
	Maximum number of repeaters (Between DP-Master and DP-Slave)	3 repeaters
	Number of connectable modules (per segment)	32 per segment (including repeaters)
	Maximum number of DP-Slaves	64 modules*3
	Number of connectable nodes (number of repeaters)	32, 62 (1), 92 (2), 122 (3), 126 (4)
	Transmittable data	Input data
Output data		Max. of 2048 bytes (Max. of 244 bytes per DP-Slave)
Number of occupied I/O points	8 points (Either input or output is available for counting.)	
Power supply	5 V DC, 150 mA (internal power supply)	
Compatible CPU module	FX5U, FX5UC: Ver. 1.110 or later Connection with FX5UC requires FX5-CNV-IFC or FX5-C1PS-5V.	
Number of occupied I/O points	8 points (Either input or output is available for counting.)	

- *1: Transmission speed accuracy is within $\pm 0.2\%$ (compliant with IEC61158-2).
- *2: For details on the transmission distance, refer to the manual.
- *3: For details on the PROFIBUS-DP network configuration, refer to the manual.

◇ Simple motion module

- FX5-40SSC-S
- FX5-80SSC-S

Control specification

Item		Specifications	
		FX5-40SSC-S	FX5-80SSC-S
Number of control axes (Virtual servo amplifier axis included)		Max. 4 axes	Max. 8 axes
Operation cycle (Operation cycle settings)		0.888 ms / 1.777 ms	
Interpolation function		Linear interpolation (up to 4-axis, 2-axis circular interpolation)	
Control system		PTP (Point To Point) control, Trajectory control (both linear and arc), Speed control, Speed-position switching control, Position-speed switching control, Speed-torque control	
Acceleration/deceleration process		Trapezoidal acceleration/deceleration, S-curve acceleration/ deceleration	
Compensation function		Backlash compensation, Electronic gear, Near pass function	
Synchronous control	Input axis	Servo input axis, synchronous encoder axis, command generation axis	
	Output axis	Cam shaft	
Cam control	Number of registered cams*1	Up to 64 cams	Up to 128 cams
	Cam data format	Stroke ratio data format, coordinate data format	
	Automatic generation of cam	Automatic generation of cam for rotary cutter	
Control unit		mm, inch, degree, pulse	
Number of positioning data		600 data (positioning data No. 1 to 600)/axis (Can be set with MELSOFT GX Works3 or a sequence program.)	
Backup		Parameters, positioning data, and block start data can be saved on flash ROM (battery-less backup)	
Home position return	Home position return method	Proximity dog method, Count method 1, Count method 2, Data set method, Scale home position signal detection method	
	Fast home position return control	Provided	
	Auxiliary functions	Home position return retry, Home position shift	
Positioning control	Linear control	Linear interpolation control (Up to 4 axes)*2 (Vector speed, Reference axis speed)	
	Fixed-pitch feed control	Fixed-pitch feed control (Up to 4 axes)	
	2-axis circular interpolation	Auxiliary point-specified circular interpolation, Central point-specified circular interpolation	
	Speed control	Speed control (Up to 4 axes)	
	Speed-position switching control	INC mode, ABS mode	
	Position-speed switching control	INC mode	
	Current value change	Positioning data, Start No. for a current value changing	
	NOP instruction	Provided	
	JUMP instruction	Unconditional JUMP, Conditional JUMP	
	LOOP, LEND	Provided	
	High-level positioning control	Block start, Condition start, Wait start, Simultaneous start, Repeated start	
Manual control	JOG operation	Provided	
	Inching operation	Provided	
	Manual pulse generator	Possible to connect 1 module (Incremental), Unit magnification (1 to 10000 times)	

Item		Specifications	
		FX5-40SSC-S	FX5-80SSC-S
Expansion control	Speed-torque control	Speed control without positioning loops, Torque control, Tightening & press-fit control	
	Absolute position system	Made compatible by setting a battery to servo amplifier	
Synchronous encoder interface		Up to 4 channels (Total of the internal interface, via PLC CPU interface, and servo amplifier interface)	
Internal interface		1 ch (Incremental)	
Functions that limit control	Speed limit function	Speed limit value, JOG speed limit value	
	Torque limit function	Torque limit value same setting, torque limit value individual setting	
	Forced stop	Valid/Invalid setting	
	Software stroke limit function	Movable range check with current feed value, movable range check with machine feed value	
	Hardware stroke limit function	Provided	
Functions that change control details	Speed change function	Provided	
	Override function	1 to 300 [%]	
	Acceleration/deceleration time change function	Provided	
Other functions	Torque change function	Provided	
	Target position change function	Target position address and speed are changeable	
	M-code output function	Provided	
	Step function	Deceleration unit step, Data No. unit step	
Parameter initialization function	Skip function	Via PLC CPU, Via external command signal	
	Teaching function	Provided	
Parameter initialization function		Provided	
External input signal setting function		Via CPU	
Amplifier-less operation function		Provided	
Mark detection function	Mark detection function		Continuous Detection mode, Specified Number of Detections mode, Ring Buffer mode
	Mark detection signal	Up to 4 points	
	Mark detection setting	16 settings	
Optional data monitor function		4 points/axis	
Driver communication function		Provided	
SSCNET connect/disconnect function		Provided	
Digital oscilloscope function*3	Bit data	16 ch	
	Word data	16 ch	

*1: The number of registered cams varies depending on the memory capacity, cam resolution, and the number of coordinates.

*2: 4-axis linear interpolation control is enabled only at the reference axis speed.

*3: 8 ch word data and 8 ch bit data can be displayed in real time.

General, power supply, input/output specifications

Module specification

Item	Specifications	
	FX5-40SSC-S	FX5-80SSC-S
Number of control axes	Max. 4 axes	Max. 8 axes
Servo amplifier connection method	SSCNET III/H	
Maximum overall cable distance [m]	400	800
Maximum distance between stations [m]	100	
Peripheral I/F	Via CPU module (Ethernet)	
Manual pulse generator operation function	Possible to connect 1 module	
Synchronous encoder operation function	Possible to connect 4 modules (Total of the internal interface, via PLC CPU interface, and servo amplifier interface)	
Input signals (DI)	No. of input points	4 points
	Input method	Positive common/Negative common shared (Photocoupler isolation)
	Rated input voltage/current	24 V DC/Approx. 5 mA
	Operating voltage range	19.2 to 26.4 V DC (24 V DC +10%/-20%, ripple ratio 5% or less)
	ON voltage/current	17.5 V DC or more/3.5 mA or more
	OFF voltage/current	7 V DC or less/1.0 mA or less
	Input resistance	Approx. 6.8 kΩ
	Response time	1 ms or less (OFF→ON, ON→OFF)
	Recommended wire size	AWG24 (0.2 mm ²)
Forced stop input signal (EMI)	No. of input points	1 point
	Input method	Positive common/Negative common shared (Photocoupler isolation)
	Rated input voltage/current	24 V DC/Approx. 5 mA
	Operating voltage range	19.2 to 26.4 V DC (24 V DC +10%/-20%, ripple ratio 5% or less)
	ON voltage/current	17.5 V DC or more/3.5 mA or more
	OFF voltage/current	7 V DC or less/1.0 mA or less
	Input resistance	Approx. 6.8 kΩ
	Response time	4 ms or less (OFF→ON, ON→OFF)
	Recommended wire size	AWG24 (0.2 mm ²)

Item	Specifications		
	FX5-40SSC-S	FX5-80SSC-S	
Signal input form	Phase A/Phase B (magnification by 4/magnification by 2/magnification by 1), PULSE/SIGN		
	Differential output type (26LS31 or equivalent)	Input pulse frequency	Max. 1 Mpulse/s (After magnification by 4, up to 4 Mpulse/s)
		Pulse width	1 μs or more
		Leading edge/trailing edge time	0.25 μs or less
		Phase difference	0.25 μs or more
		Rated input voltage	5.5 V DC or less
		High/Low-voltage	2.0 to 5.25 V DC/0 to 0.8 V DC
		Differential voltage	±0.2 V
		Cable length	Up to 30 m
	Manual pulse generator / Incremental synchronous encoder signal	Voltageoutput/ Opencollector type (5 V DC)	Input pulse frequency
Pulse width			5 μs or more
Leading edge/trailing edge time			1.2 μs or less
Phase difference			1.2 μs or more
Rated input voltage			5.5 V DC or less
High/Low-voltage			3.0 to 5.25 V DC/2 mA or less, 0 to 1.0 V DC/5 mA or more
Cable length			Up to 10 m
Compatible CPU module	Compatible with FX5U and FX5UC, from their first released products		
Number of occupied input/output points	8 points (Either input or output is available for counting.)		
Power supply	24 V DC +20%/-15% (external power supply)		

External Dimensions

Unit: mm

CPU module

2-φ4.5 mounting hole (FX5U-32M□)
 4-φ4.5 mounting hole (FX5U-64M□, FX5U-80M□)
 There is no mounting hole marked with * in FX5U-32M□.

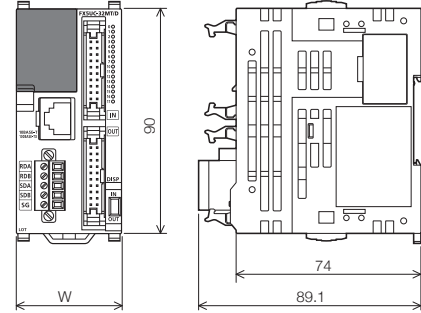
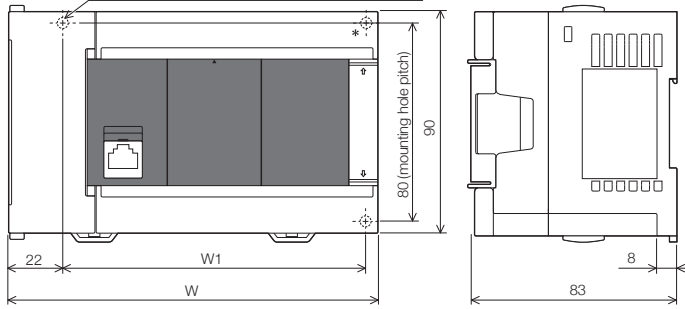

- External color: Main body, Munsell 0.6B7.6/0.2

Model	W: mm	W1: mm Mounting hole pitches	MASS (Weight): kg
FX5U-32MR/ES, FX5U-32MT/ES, FX5U-32MT/ESS FX5U-32MR/DS, FX5U-32MT/DS, FX5U-32MT/DSS	150	123	Approx. 0.7
FX5U-64MR/ES, FX5U-64MT/ES, FX5U-64MT/ESS FX5U-64MR/DS, FX5U-64MT/DS, FX5U-64MT/DSS	220	193	Approx. 1.0
FX5U-80MR/ES, FX5U-80MT/ES, FX5U-80MT/ESS FX5U-80MR/DS, FX5U-80MT/DS, FX5U-80MT/DSS	285	258	Approx. 1.2

- External color: Main body, Munsell 0.6B7.6/0.2

- Accessories: FX2NC-100MPCB type power cable
 FX2NC-100BPCB type power cable (FX5UC-□MT/D only)

Model	W: mm	MASS (Weight): kg
FX5UC-32MT/D, FX5UC-32MT/DSS	42.1	Approx. 0.2
FX5UC-64MT/D, FX5UC-64MT/DSS	62.2	Approx. 0.3
FX5UC-96MT/D, FX5UC-96MT/DSS	82.3	Approx. 0.35

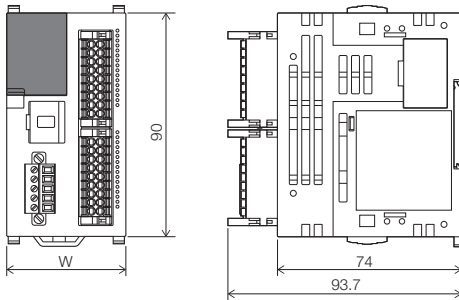

- External color: Main body, Munsell 0.6B7.6/0.2
 - Accessories: FX2NC-100MPCB type power cable

Model	W: mm	MASS (Weight): kg
FX5UC-32MT/DS-TS, FX5UC-32MT/DSS-TS	48.1	Approx. 0.25
FX5UC-32MR/DS-TS	68.2	Approx. 0.35

External Dimensions

Unit: mm

I/O module

Input module/output module (extension cable type), high-speed pulse input/output module

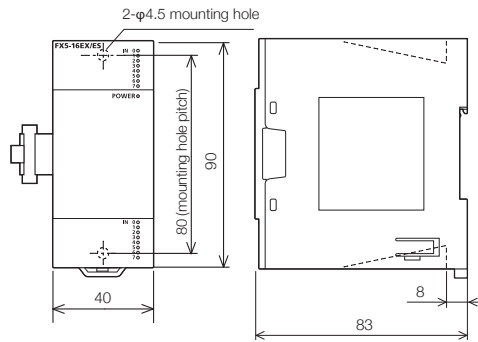

- External color: Munsell 0.6B7.6/0.2

Model	MASS (Weight): kg
FX5-8EX/ES, FX5-8EYR/ES, FX5-8EYT/ES, FX5-8EYT/ESS	Approx. 0.2
FX5-16EX/ES, FX5-16EYR/ES, FX5-16EYT/ES, FX5-16EYT/ESS, FX5-16ER/ES, FX5-16ET/ES, FX5-16ET/ESS, FX5-16ET/ES-H, FX5-16ET/ESS-H	Approx. 0.25

Powered input/output modules

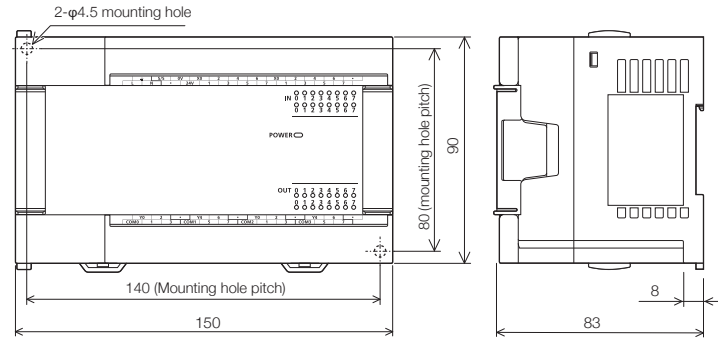

- External color: Munsell 0.6B7.6/0.2
- Accessories: Extension cable

Model	MASS (Weight): kg
FX5-32ER/ES, FX5-32ET/ES, FX5-32ET/ESS FX5-32ER/DS, FX5-32ET/DS, FX5-32ET/DSS	Approx. 0.65

Input module/output module (extension connector type)

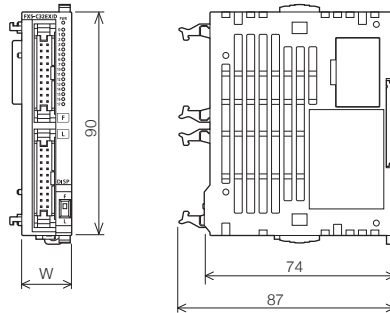

- External color: Munsell 0.6B7.6/0.2

Model	W: mm	MASS (Weight): kg
FX5-C16EX/D, FX5-C16EX/DS FX5-C16EYT/D, FX5-C16EYT/DSS	14.6	Approx. 0.1
FX5-C32EX/D, FX5-C32EX/DS FX5-C32EYT/D, FX5-C32EYT/DSS	20.1	Approx. 0.15

I/O module (extension connector type)

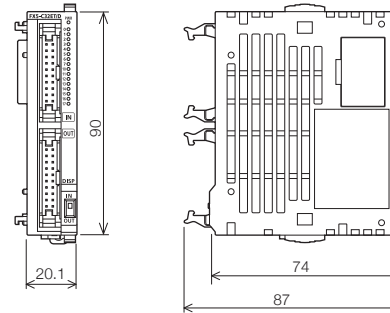

- External color: Munsell 0.6B7.6/0.2

Model	MASS (Weight): kg
FX5-C32ET/D, FX5-C32ET/DSS	Approx. 0.15

Input module/output module/I/O module (Spring clamp terminal block type)

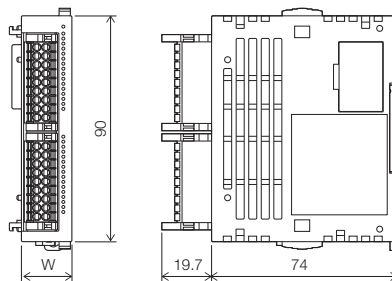

- External color: Main body, Munsell 0.6B7.6/0.2

Model	W: mm	MASS (Weight): kg
FX5-C16EYR/D-TS	30.7	Approx. 0.2
FX5-C32EX/DS-TS, FX5-C32EYT/D-TS, FX5-C32EYT/DSS-TS, FX5-C32ET/DS-TS, FX5-C32ET/DSS-TS	20.1	Approx. 0.15

External Dimensions

Unit: mm

Intelligent function module

FX5-40SSC-S/FX5-80SSC-S

- MASS (Weight): Approx. 0.3 kg
- External color: Munsell 0.6B7.6/0.2

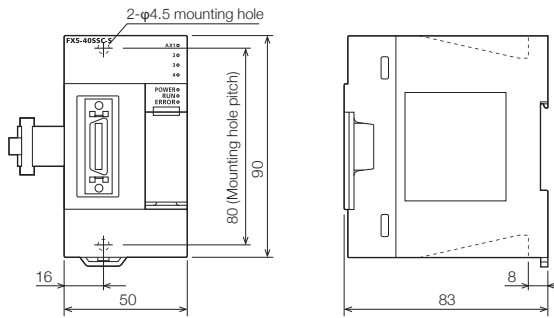

FX5-4AD/FX5-4DA

- MASS (Weight): Approx. 0.2 kg
- External color: Munsell 0.6B7.6/0.2

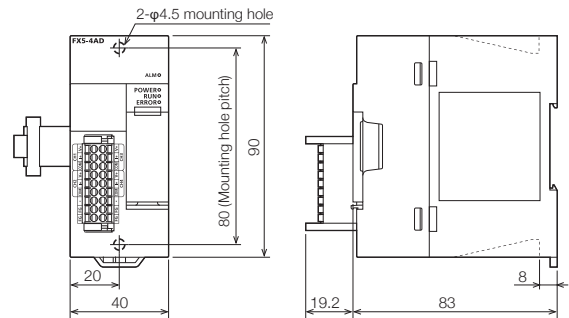

FX5-8AD

- MASS (Weight): Approx. 0.3 kg
- External color: Munsell 0.6B7.6/0.2

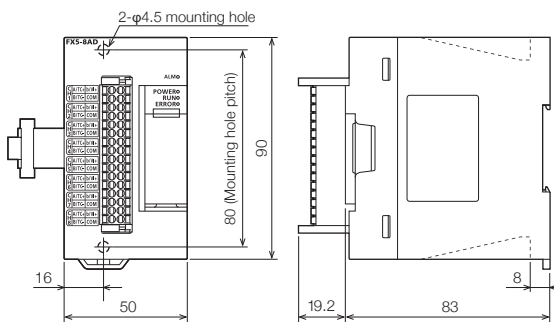

FX5-4LC

- MASS (Weight): Approx. 0.3 kg
- External color: Munsell 0.6B7.6/0.2

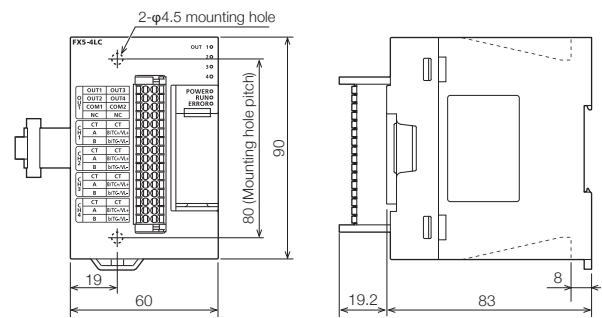

FX5-20PG-P/FX5-20PG-D

- MASS (Weight): Approx. 0.2 kg
- External color: Munsell 0.6B7.6/0.2

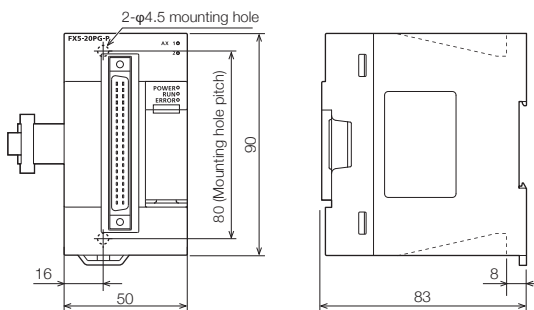

FX5-CCL-MS

- MASS (Weight): Approx. 0.3 kg
- External color: Munsell 0.6B7.6/0.2

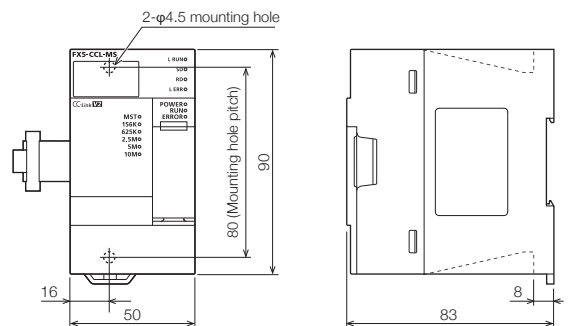

FX5-CCLIEF

- MASS (Weight): Approx. 0.3 kg
- External color: Munsell 0.6B7.6/0.2

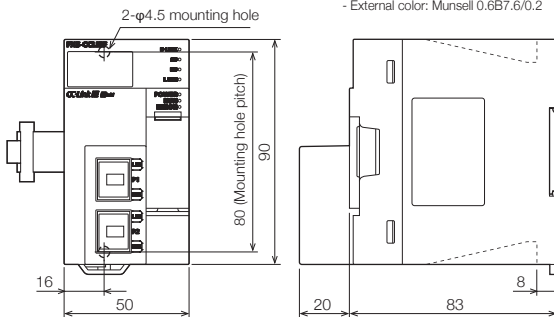

FX5-ASL-M

- MASS (Weight): Approx. 0.2 kg
- External color: Munsell 0.6B7.6/0.2

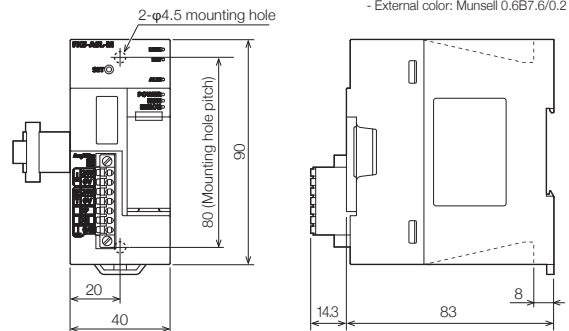

External Dimensions

Unit: mm

FX5-DP-M

- MASS (Weight): Approx. 0.2 kg
- External color: Munsell 0.6B7.6/0.2

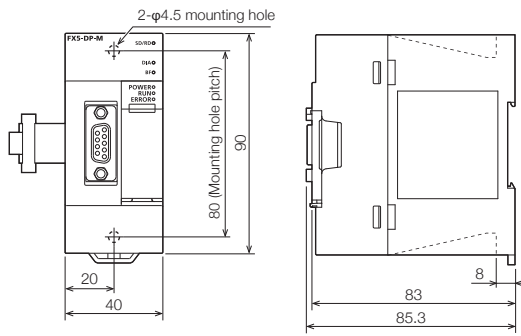

FX5-ENET

- MASS (Weight): Approx. 0.2 kg
- External color: Munsell 0.6B7.6/0.2

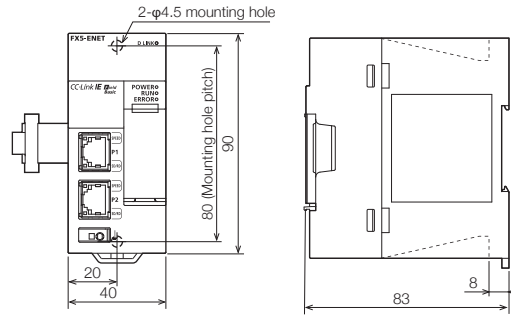

FX5-ENET/IP

- MASS (Weight): Approx. 0.2 kg
- External color: Munsell 0.6B7.6/0.2

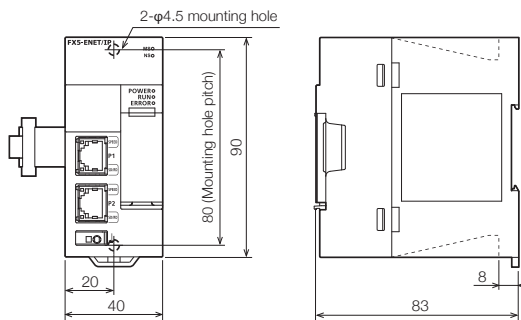

Expansion adapter

FX5-4AD-ADP/FX5-4DA-ADP

- MASS (Weight): Approx. 0.1 kg
- External color: Munsell 0.6B7.6/0.2

FX5-4AD-PT-ADP/FX5-4AD-TC-ADP

FX5-232ADP/FX5-485ADP

- MASS (Weight): Approx. 0.08 kg
- External color: Munsell 0.6B7.6/0.2

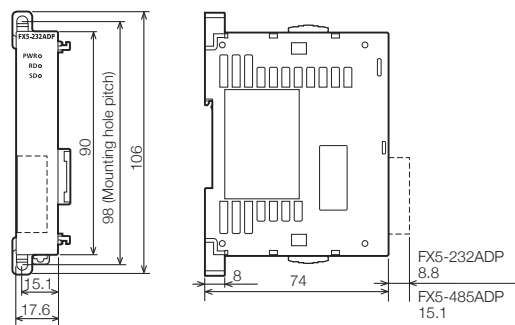
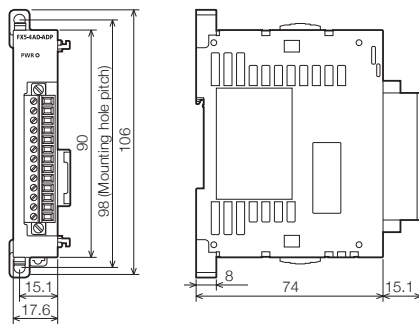

Expansion board

FX5-232-BD

FX5-485-BD

FX5-422-BD-GOT

- MASS (Weight):
Approx. 0.02 kg
- External color: Munsell N1.5

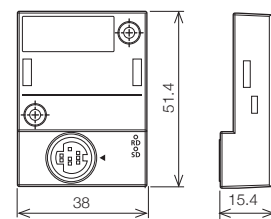
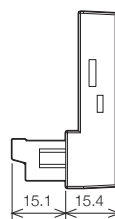
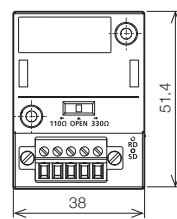
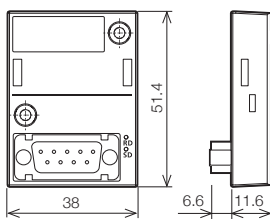

Unit: mm

Bus conversion module

FX5-CNV-BUS

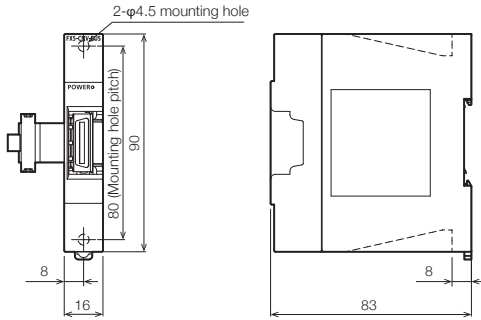

FX5-CNV-BUSC

- MASS (Weight): Approx. 0.1 kg
- External color: Munsell 0.6B7.6/0.2

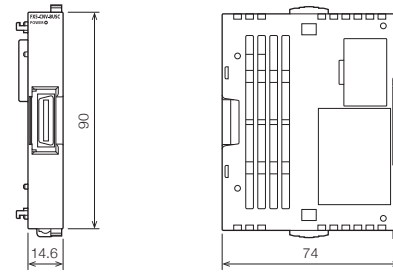

Connector conversion module

FX5-CNV-IF

- MASS (Weight): Approx. 0.06 kg
- External color: Munsell 0.6B7.6/0.2
- Accessory: Extension cable

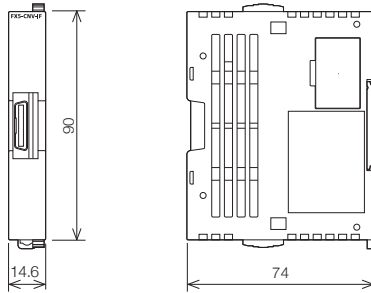

FX5-CNV-IFC

- MASS (Weight): Approx. 0.06 kg
- External color: Munsell 0.6B7.6/0.2

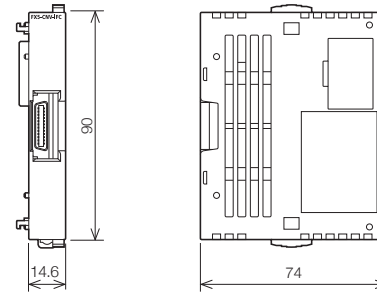

Connector conversion adapter

FX5-CNV-BC

- MASS (Weight): Approx. 0.04 kg
- External color: Munsell 0.08GY7.64/0.81

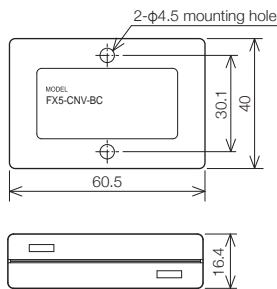

FX5 extension power supply module

FX5-1PSU-5V

- MASS (Weight): Approx. 0.3 kg
- External color: Munsell 0.6B7.6/0.2
- Accessories: Extension cable
- M3 terminal screw for terminal block
- DIN rail of 35 mm in width can be installed

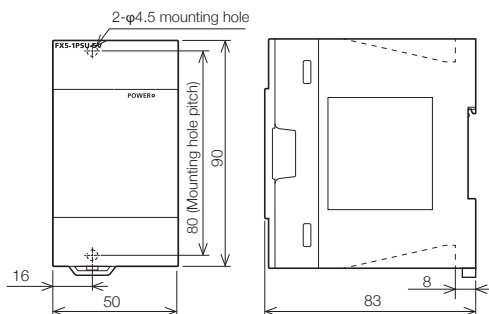

FX5-C1PS-5V

- MASS (Weight): Approx. 0.1 kg
- External color: Munsell 0.6B7.6/0.2

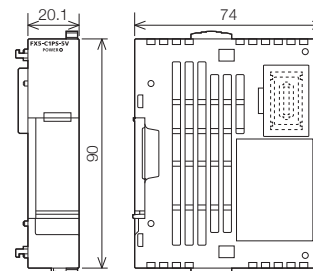

External Dimensions

Unit: mm

FX3 extension power supply module

FX3U-1PSU-5V

- MASS (Weight): Approx. 0.3 kg
- External color: Munsell 0.08GY/7.64/0.81
- Accessories: Extension cable
- M3 terminal screw for terminal block
- DIN rail of 35 mm in width can be installed

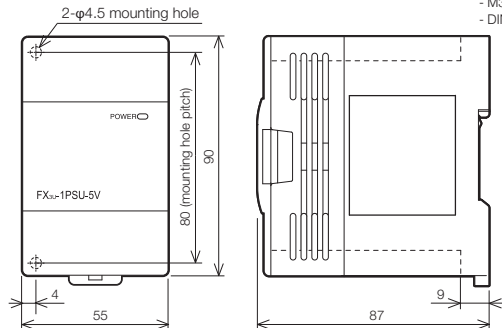

FX3 intelligent function module

FX3U-4AD/FX3U-4DA

FX3U-64CCL/FX3U-16CCL-M

- External color: Munsell 0.08GY/7.64/0.81
- Accessories: Special block No. label, dust sheet, and terminating resistor*
- M3 terminal screw for terminal block
- DIN rail of 35 mm in width can be installed
- *: Attached only to FX3U-16CCL-M

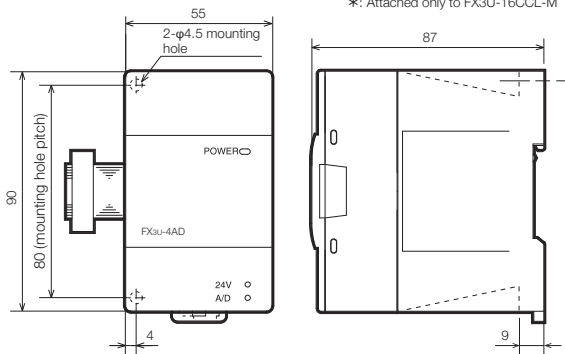

Model	MASS (Weight): kg
FX3U-4AD, FX3U-4DA	Approx. 0.2
FX3U-64CCL, FX3U-16CCL-M	Approx. 0.3

FX3U-4LC

- Mass (Weight): Approx. 0.4 kg
- External color: Munsell 0.08GY/7.64/0.81
- M3 terminal screw for terminal block
- DIN rail of 35 mm in width can be installed

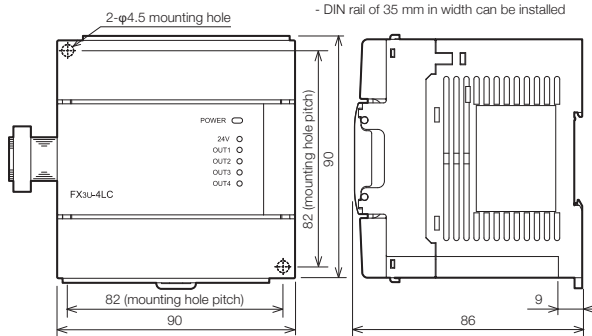

FX3U-2HC

- Mass (Weight): Approx. 0.2 kg
- External color: Munsell 0.08GY/7.64/0.81
- DIN rail of 35 mm in width can be installed

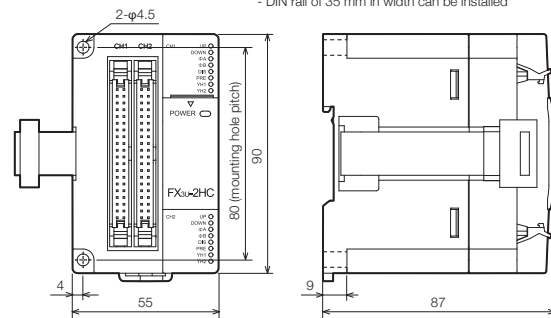

FX3U-1PG

- Mass (Weight): Approx. 0.2 kg
- External color: Munsell 0.08GY/7.64/0.81
- M3 terminal screw for terminal block
- DIN rail of 35 mm in width can be installed

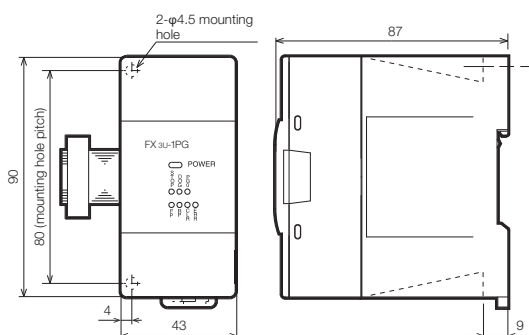

FX3U-128ASL-M

- Mass (Weight): Approx. 0.2 kg
- External color: Munsell 0.08GY/7.64/0.81
- DIN rail of 35 mm in width can be installed

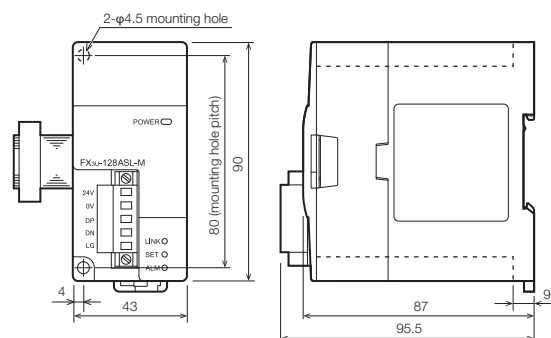

FX3U-32DP

- Mass (Weight): Approx. 0.2 kg
- External color: Munsell 0.08GY/7.64/0.81

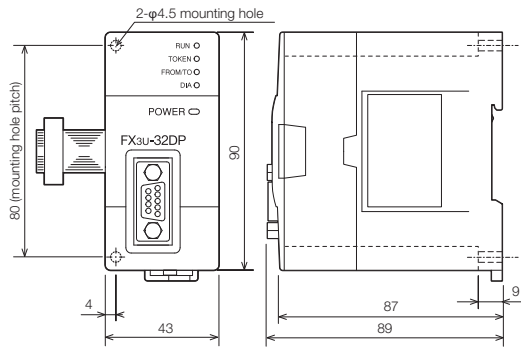

Terminal module (common to all models)

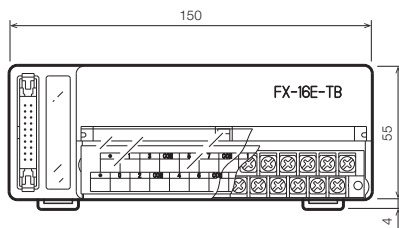

- External color: Munsell 0.08GY/7.64/0.81
- Accessory: Terminal block arrangement card
- M3.5 terminal screw for terminal block
- DIN rail of 35 mm in width can only be installed

Terminal arrangement

FX5U CPU module

FX5U-32MR/ES, FX5U-32MT/ES

$\frac{\perp}{\perp}$	S/S	0V	X0	2	4	6	X10	12	14	16	•
L	N	•	24V	1	3	5	7	11	13	15	17
Y0	2	•	Y4	6	•	Y10	12	•	Y14	16	•
COM0	1	3	COM1	5	7	COM2	11	13	COM3	15	17

FX5U-32MR/DS, FX5U-32MT/DS

$\frac{\perp}{\perp}$	S/S	•	X0	2	4	6	X10	12	14	16	•
⊕	⊖	•	•	1	3	5	7	11	13	15	17
Y0	2	•	Y4	6	•	Y10	12	•	Y14	16	•
COM0	1	3	COM1	5	7	COM2	11	13	COM3	15	17

FX5U-32MT/ESS

Y0	2	•	Y4	6	•	Y10	12	•	Y14	16	•
+V0	1	3	+V1	5	7	+V2	11	13	+V3	15	17

FX5U-32MT/DSS

Y0	2	•	Y4	6	•	Y10	12	•	Y14	16	•
+V0	1	3	+V1	5	7	+V2	11	13	+V3	15	17

FX5U-64MR/ES, FX5U-64MT/ES

$\frac{\perp}{\perp}$	S/S	0V	0V	X0	2	4	6	X10	12	14	16	X20	22	24	26	X30	32	34	36	•
L	N	•	24V	24V	1	3	5	7	11	13	15	17	21	23	25	27	31	33	35	37
Y0	2	•	Y4	6	•	Y10	12	•	Y14	16	•	Y20	22	24	26	Y30	32	34	36	COM5
COM0	1	3	COM1	5	7	COM2	11	13	COM3	15	17	COM4	21	23	25	27	31	33	35	37

FX5U-64MT/ESS

Y0	2	•	Y4	6	•	Y10	12	•	Y14	16	•	Y20	22	24	26	Y30	32	34	36	+V5
+V0	1	3	+V1	5	7	+V2	11	13	+V3	15	17	+V4	21	23	25	27	31	33	35	37

FX5U-64MR/DS, FX5U-64MT/DS

$\frac{\perp}{\perp}$	S/S	•	•	X0	2	4	6	X10	12	14	16	X20	22	24	26	X30	32	34	36	•
⊕	⊖	•	•	•	1	3	5	7	11	13	15	17	21	23	25	27	31	33	35	37
Y0	2	•	Y4	6	•	Y10	12	•	Y14	16	•	Y20	22	24	26	Y30	32	34	36	COM5
COM0	1	3	COM1	5	7	COM2	11	13	COM3	15	17	COM4	21	23	25	27	31	33	35	37

FX5U-64MT/DSS

Y0	2	•	Y4	6	•	Y10	12	•	Y14	16	•	Y20	22	24	26	Y30	32	34	36	+V5
+V0	1	3	+V1	5	7	+V2	11	13	+V3	15	17	+V4	21	23	25	27	31	33	35	37

FX5U CPU module

FX5U-80MR/ES, FX5U-80MT/ES

⊥	S/S	0V	0V	X0	2	4	6	X10	12	14	16					X20	22	24	26			X30	32	34	36			X40	42	44	46		
L	N	•	24V	24V	1	3	5	7	11	13	15				17	•	21	23	25	27	•	31	33	35	37	•	41	43	45	47			
Y0	2	•	Y4	6	•	Y10	12	•	Y14	16	•	Y20	22	24	26																		
COM0	1	3	COM1	5	7	COM2	11	13	COM3	15	17	COM4	21	23	25					27	•	COM5	31	33	35	37	COM6	41	43	45	47		

FX5U-80MT/ESS

Y0	2	•	Y4	6	•	Y10	12	•	Y14	16	•	Y20	22	24	26																		
+V0	1	3	+V1	5	7	+V2	11	13	+V3	15	17	+V4	21	23	25					27	•	+V5	31	33	35	37	+V6	41	43	45	47		

FX5U-80MR/DS, FX5U-80MT/DS

⊥	S/S	•	•	X0	2	4	6	X10	12	14	16					X20	22	24	26			X30	32	34	36			X40	42	44	46		
⊕	⊖	•	•	•	1	3	5	7	11	13	15				17	•	21	23	25	27	•	31	33	35	37	•	41	43	45	47			
Y0	2	•	Y4	6	•	Y10	12	•	Y14	16	•	Y20	22	24	26																		
COM0	1	3	COM1	5	7	COM2	11	13	COM3	15	17	COM4	21	23	25					27	•	COM5	31	33	35	37	COM6	41	43	45	47		

FX5U-80MT/DSS

Y0	2	•	Y4	6	•	Y10	12	•	Y14	16	•	Y20	22	24	26																		
+V0	1	3	+V1	5	7	+V2	11	13	+V3	15	17	+V4	21	23	25					27	•	+V5	31	33	35	37	+V6	41	43	45	47		

Terminal arrangement

FX5UC CPU module

FX5UC-32MT/D

Input	
X0	X10
X1	X11
X2	X12
X3	X13
X4	X14
X5	X15
X6	X16
X7	X17
COM	COM
.	.
Output	
Y0	Y10
Y1	Y11
Y2	Y12
Y3	Y13
Y4	Y14
Y5	Y15
Y6	Y16
Y7	Y17
COM0	COM0
.	.

FX5UC-32MT/DSS

Input	
X0	X10
X1	X11
X2	X12
X3	X13
X4	X14
X5	X15
X6	X16
X7	X17
COM0	COM0
.	.
Output	
Y0	Y10
Y1	Y11
Y2	Y12
Y3	Y13
Y4	Y14
Y5	Y15
Y6	Y16
Y7	Y17
+V0	+V0
.	.

FX5UC-32MT/DS-TS

Input	
X0	X10
X1	X11
X2	X12
X3	X13
X4	X14
X5	X15
X6	X16
X7	X17
S/S	S/S
Output	
Y0	Y10
Y1	Y11
Y2	Y12
Y3	Y13
Y4	Y14
Y5	Y15
Y6	Y16
Y7	Y17
COM0	COM0

FX5UC-32MT/DSS-TS

Input	
X0	X10
X1	X11
X2	X12
X3	X13
X4	X14
X5	X15
X6	X16
X7	X17
S/S	S/S
Output	
Y0	Y10
Y1	Y11
Y2	Y12
Y3	Y13
Y4	Y14
Y5	Y15
Y6	Y16
Y7	Y17
+V0	+V0

FX5UC-32MR/DS-TS

Input*	
X0	X0
X1	X1
X2	X2
X3	X3
X4	X4
X5	X5
X6	X6
X7	X7
S/S0	S/S0
Input*	
X10	X10
X11	X11
X12	X12
X13	X13
X14	X14
X15	X15
X16	X16
X17	X17
S/S1	S/S1
Output*	
Y0	Y0
Y1	Y1
Y2	Y2
Y3	Y3
Y4	Y4
Y5	Y5
Y6	Y6
Y7	Y7
COM0	COM0
Output*	
Y10	Y10
Y11	Y11
Y12	Y12
Y13	Y13
Y14	Y14
Y15	Y15
Y16	Y16
Y17	Y17
COM1	COM1

FX5UC-64MT/D

Input	
X0	X10
X1	X11
X2	X12
X3	X13
X4	X14
X5	X15
X6	X16
X7	X17
COM	COM
.	.
Input	
X20	X30
X21	X31
X22	X32
X23	X33
X24	X34
X25	X35
X26	X36
X27	X37
COM	COM
.	.
Output	
Y0	Y10
Y1	Y11
Y2	Y12
Y3	Y13
Y4	Y14
Y5	Y15
Y6	Y16
Y7	Y17
COM0	COM0
.	.
Output	
Y20	Y30
Y21	Y31
Y22	Y32
Y23	Y33
Y24	Y34
Y25	Y35
Y26	Y36
Y27	Y37
COM1	COM1
.	.

FX5UC-64MT/DSS

Input	
X0	X10
X1	X11
X2	X12
X3	X13
X4	X14
X5	X15
X6	X16
X7	X17
COM0	COM0
.	.
Input	
X20	X30
X21	X31
X22	X32
X23	X33
X24	X34
X25	X35
X26	X36
X27	X37
COM1	COM1
.	.
Output	
Y0	Y10
Y1	Y11
Y2	Y12
Y3	Y13
Y4	Y14
Y5	Y15
Y6	Y16
Y7	Y17
+V0	+V0
.	.
Output	
Y20	Y30
Y21	Y31
Y22	Y32
Y23	Y33
Y24	Y34
Y25	Y35
Y26	Y36
Y27	Y37
+V1	+V1
.	.

*: Terminals with the same name (such as X0 and X0) are connected inside the PLC.

FX5UC-96MT/D

Input		Input		Input	
X0	X10	X20	X30	X40	X50
X1	X11	X21	X31	X41	X51
X2	X12	X22	X32	X42	X52
X3	X13	X23	X33	X43	X53
X4	X14	X24	X34	X44	X54
X5	X15	X25	X35	X45	X55
X6	X16	X26	X36	X46	X56
X7	X17	X27	X37	X47	X57
COM	COM	COM	COM	COM	COM
.

Notch

Output		Output		Output	
Y0	Y10	Y20	Y30	Y40	Y50
Y1	Y11	Y21	Y31	Y41	Y51
Y2	Y12	Y22	Y32	Y42	Y52
Y3	Y13	Y23	Y33	Y43	Y53
Y4	Y14	Y24	Y34	Y44	Y54
Y5	Y15	Y25	Y35	Y45	Y55
Y6	Y16	Y26	Y36	Y46	Y56
Y7	Y17	Y27	Y37	Y47	Y57
COM0	COM0	COM1	COM1	COM2	COM2
.

Notch

FX5UC-96MT/DSS

Input		Input		Input	
X0	X10	X20	X30	X40	X50
X1	X11	X21	X31	X41	X51
X2	X12	X22	X32	X42	X52
X3	X13	X23	X33	X43	X53
X4	X14	X24	X34	X44	X54
X5	X15	X25	X35	X45	X55
X6	X16	X26	X36	X46	X56
X7	X17	X27	X37	X47	X57
COM0	COM0	COM1	COM1	COM2	COM2
.

Notch

Output		Output		Output	
Y0	Y10	Y20	Y30	Y40	Y50
Y1	Y11	Y21	Y31	Y41	Y51
Y2	Y12	Y22	Y32	Y42	Y52
Y3	Y13	Y23	Y33	Y43	Y53
Y4	Y14	Y24	Y34	Y44	Y54
Y5	Y15	Y25	Y35	Y45	Y55
Y6	Y16	Y26	Y36	Y46	Y56
Y7	Y17	Y27	Y37	Y47	Y57
+V0	+V0	+V1	+V1	+V2	+V2
.

Notch

Terminal arrangement

I/O module

◇ Input module/output module (extension cable type)

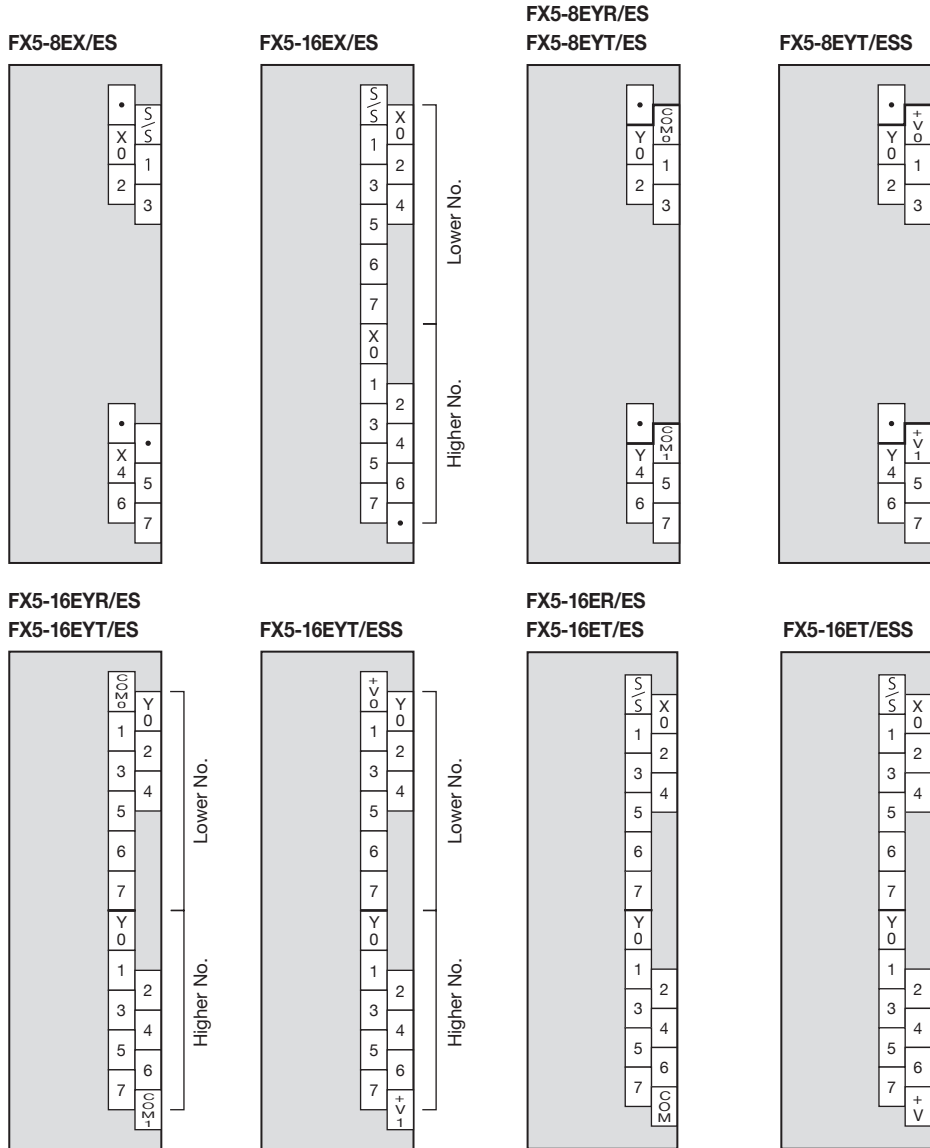

◇ High-speed pulse input/output module

FX5-16ET/ES-H

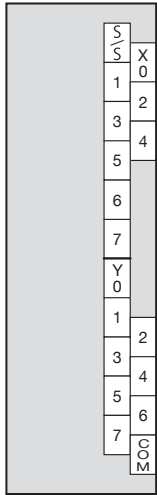

FX5-16ET/ESS-H

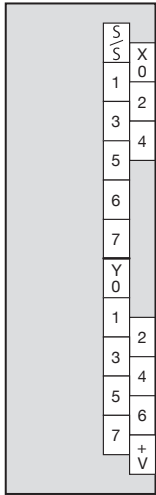

◇ Powered input/output modules

FX5-32ER/ES, FX5-32ET/ES

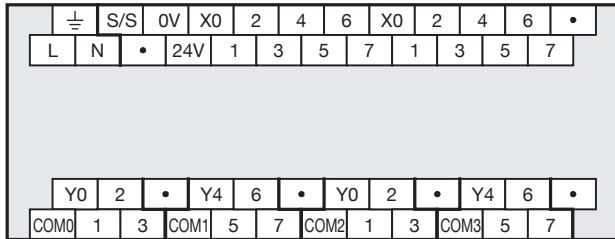

FX5-32ER/DS, FX5-32ET/DS

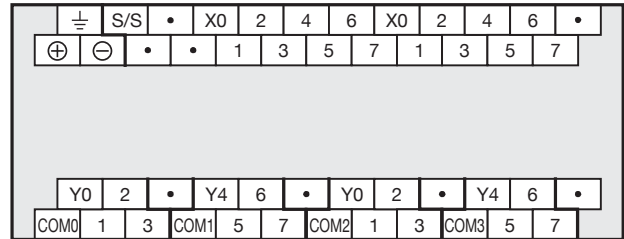

FX5-32ET/ESS

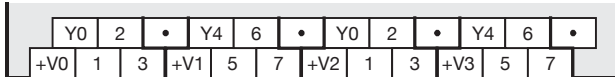

FX5-32ET/DSS

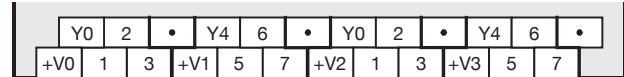

Terminal arrangement

I/O module

◇ Input module/output module (extension connector type)

FX5-C16EX/D

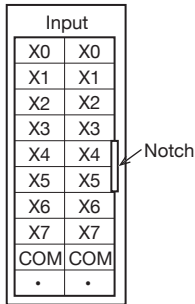

FX5-C16EX/DS

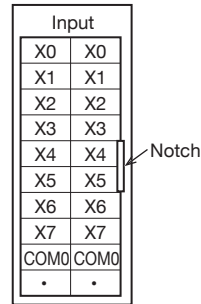

FX5-C32EX/D

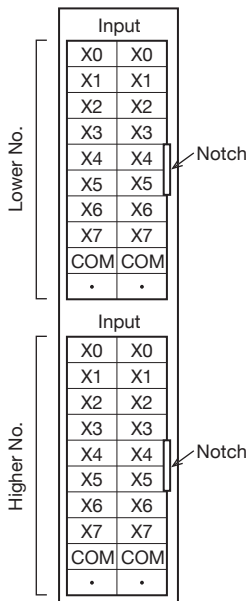

FX5-C32EX/DS

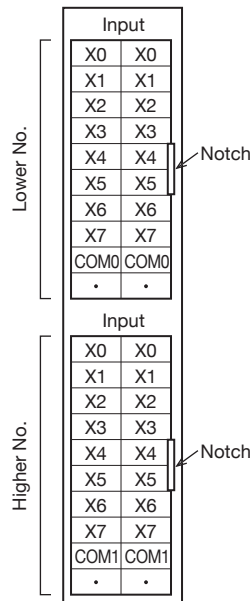

FX5-C32EX/DS-TS

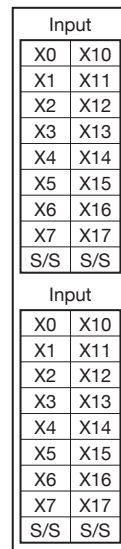

FX5-C16EYT/D

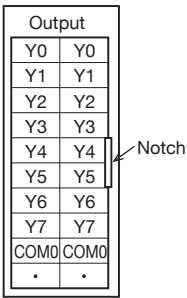

FX5-C16EYT/DSS

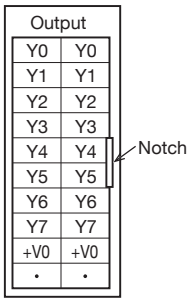

FX5-C32EYT/D

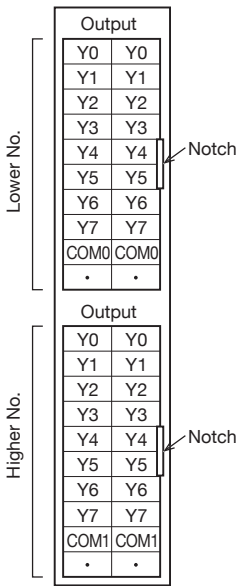

FX5-C32EYT/D-TS

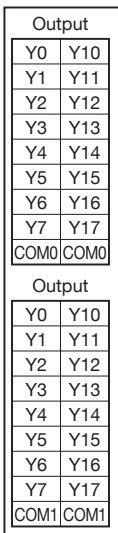

FX5-C32EYT/DSS

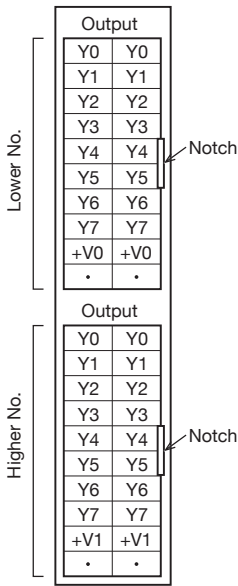

FX5-C32EYT/DSS-TS

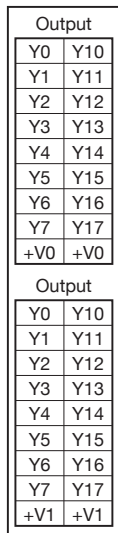

FX5-C16EYR/D-TS

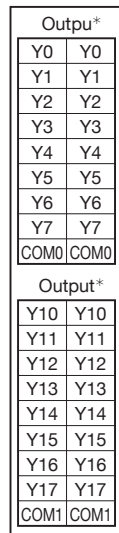

*: Terminals with the same name (such as Y0 and Y0) are connected inside the PLC.

Terminal arrangement

◇ I/O module (extension connector type)

FX5-C32ET/D

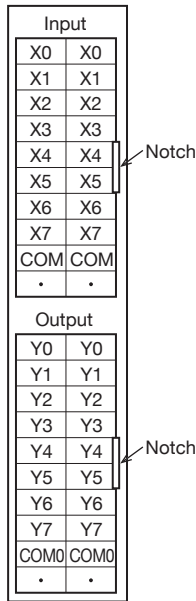

FX5-C32ET/DS-TS

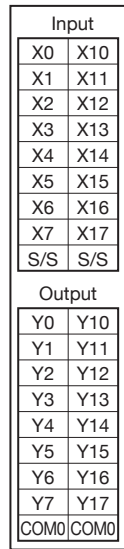

FX5-C32ET/DSS

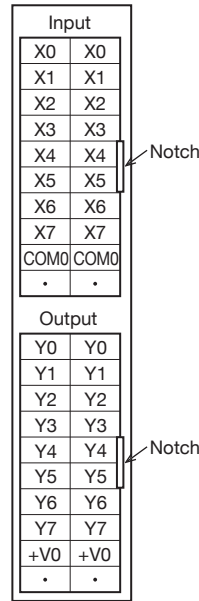

FX5-C32ET/DSS-TS

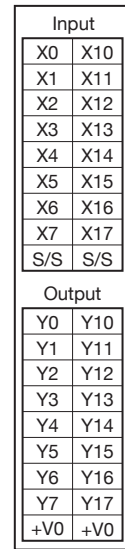

FX5 intelligent function module

FX5-4AD

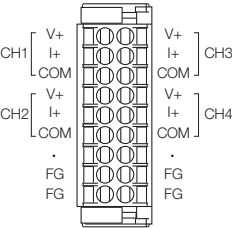

FX5-4DA

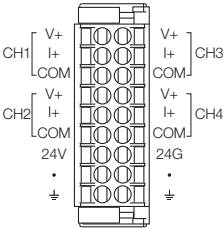

FX5-8AD

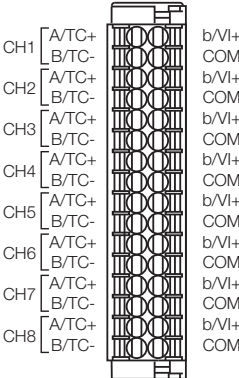

FX5-4LC

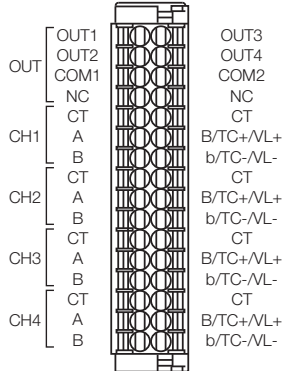

FX5-20PG-P

		Axis 2 (AX2)		Axis 1 (AX1)	
		Pin No.	Signal name	Pin No.	Signal name
B20	□ □	A20		B20	PULSER B-
B19	□ □	A19		A20	PULSER B+
B18	□ □	A18		B19	PULSER A-
B17	□ □	A17		A19	PULSER A+
B16	□ □	A16		B18	PULSE COM
B15	□ □	A15		A18	PULSE COM
B14	□ □	A14		B17	PULSE R
B13	□ □	A13		A17	PULSE R
B12	□ □	A12		B16	PULSE COM
B11	□ □	A11		A16	PULSE COM
B10	□ □	A10		B15	PULSE F
B9	□ □	A9		A15	PULSE F
B8	□ □	A8		B14	CLRCOM
B7	□ □	A7		A14	CLRCOM
B6	□ □	A6		B13	CLEAR
B5	□ □	A5		A13	CLEAR
B4	□ □	A4		B12	RDYCOM
B3	□ □	A3		A12	RDYCOM
B2	□ □	A2		B11	READY
B1	□ □	A1		A11	READY
				B10	PG0COM
				A10	PG0COM
				B9	PG05
				A9	PG05
				B8	PG024
				A8	PG024
				B7	COM
				A7	COM
				B6	COM
				A6	COM
				B5	CHG
				A5	CHG
				B4	STOP
				A4	STOP
				B3	DOG
				A3	DOG
				B2	RLS
				A2	RLS
				B1	FLS
				A1	FLS

FX5-20PG-D

		Axis 2 (AX2)		Axis 1 (AX1)	
		Pin No.	Signal name	Pin No.	Signal name
B20	□ □	A20		B20	PULSER B-
B19	□ □	A19		A20	PULSER B+
B18	□ □	A18		B19	PULSER A-
B17	□ □	A17		A19	PULSER A+
B16	□ □	A16		B18	PULSE R-
B15	□ □	A15		A18	PULSE R-
B14	□ □	A14		B17	PULSE R+
B13	□ □	A13		A17	PULSE R+
B12	□ □	A12		B16	PULSE F-
B11	□ □	A11		A16	PULSE F-
B10	□ □	A10		B15	PULSE F+
B9	□ □	A9		A15	PULSE F+
B8	□ □	A8		B14	CLRCOM
B7	□ □	A7		A14	CLRCOM
B6	□ □	A6		B13	CLEAR
B5	□ □	A5		A13	CLEAR
B4	□ □	A4		B12	RDYCOM
B3	□ □	A3		A12	RDYCOM
B2	□ □	A2		B11	READY
B1	□ □	A1		A11	READY
				B10	PG0COM
				A10	PG0COM
				B9	PG05
				A9	PG05
				B8	PG024
				A8	PG024
				B7	COM
				A7	COM
				B6	COM
				A6	COM
				B5	CHG
				A5	CHG
				B4	STOP
				A4	STOP
				B3	DOG
				A3	DOG
				B2	RLS
				A2	RLS
				B1	FLS
				A1	FLS

FX5-40SSC-S
FX5-80SSC-S

Pin No.	Signal name	Pin No.	Signal name
1	Idle	14	Idle
2	SG	15	SG
3	HA	16	HB
4	HAH	17	HBH
5	HAL	18	HBL
6 to 9	Idle	19 to 22	Idle
10	EMI	23	EMI.COM
11	DI1	24	DI2
12	DI3	25	DI4
13	COM	26	COM

FX5-ENET
FX5-ENET/IP

Pin No.	Signal name	Description
1	TP0+	Data 0 transmission/reception (positive side)
2	TP0-	Data 0 transmission/reception (negative side)
3	TP1+	Data 1 transmission/reception (positive side)
4	TP2+	Data 2 transmission/reception (positive side)
5	TP2-	Data 2 transmission/reception (negative side)
6	TP1-	Data 1 transmission/reception (negative side)
7	TP3+	Data 3 transmission/reception (positive side)
8	TP3-	Data 3 transmission/reception (negative side)

Terminal arrangement

FX5-CCL-MS

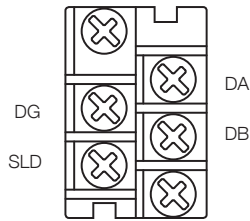

FX5-CCLIEF

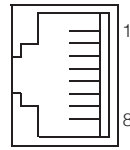

Pin No.	Signal name	Direction	Description
1	TP0	+	Data 0 transmission/reception (positive side)
2	TP0	-	Data 0 transmission/reception (negative side)
3	TP1	+	Data 1 transmission/reception (positive side)
4	TP2	+	Data 2 transmission/reception (positive side)
5	TP2	-	Data 2 transmission/reception (negative side)
6	TP1	-	Data 1 transmission/reception (negative side)
7	TP3	+	Data 3 transmission/reception (positive side)
8	TP3	-	Data 3 transmission/reception (negative side)

FX5-ASL-M

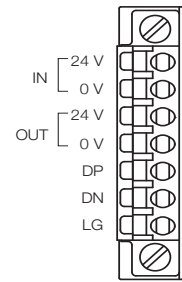

FX5-DP-M

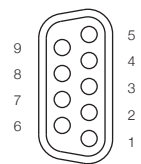

Pin No.	Signal name	Description
1	NC	Not connected
2	NC	Not connected
3	RxD/TxD-P	Receive/send data-P
4	CNTR-P*1	Control signal of repeaters
5	DGND*2	Data ground
6	VP*2	Voltage+
7	NC	Not connected
8	RxD/TxD-N	Receive/send data-N
9	NC	Not connected

*1: Optional signal
*2: Signal used for connecting a bus terminator

Expansion adapter

FX5-4AD-ADP

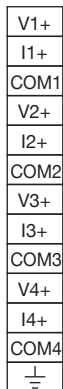

FX5-4DA-ADP

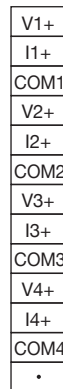

FX5-4AD-PT-ADP

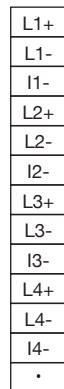

FX5-4AD-TC-ADP

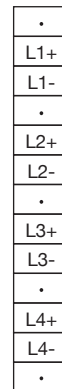

FX5-232ADP

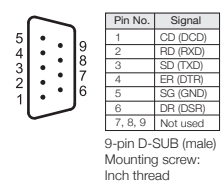

FX5-485ADP



Expansion board

FX5-232-BD

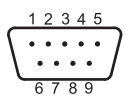

Pin No.	Signal
1	CD (DCD)
2	RD (RXD)
3	SD (TXD)
4	ER (DTR)
5	SG (GND)
6	DR (DSR)
7, 8, 9	Not used

9-pin D-SUB (male)
Mounting screw:
Inch thread

FX5-485-BD

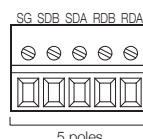

5 poles

Signal Name
RDA (RXD+)
RDB (RXD-)
SDA (TXD+)
SDB (TXD-)
SG (GND)

FX5-422-BD-GOT



8-pin MINI-DIN (female)

FX5 extension power supply module

FX3 extension power supply module

FX5-1PSU-5V



FX5-C1PS-5V



FX3U-1PSU-5V



FX3 intelligent function module

FX3U-4AD



FX3U-4DA



FX3U-4LC

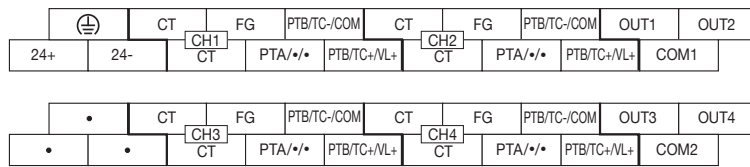

FX3U-2HC

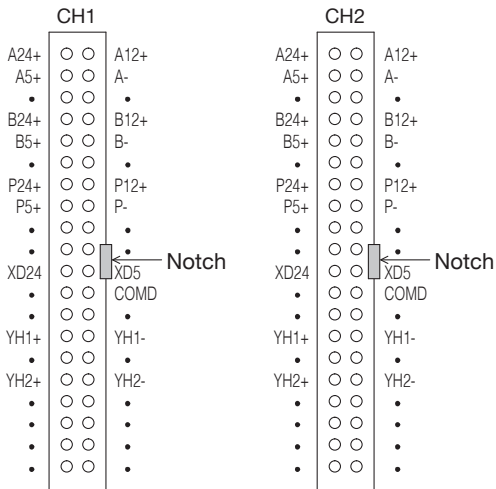

FX3U-1PG

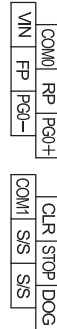

FX3U-64CCL

FX3U-16CCL-M



FX3U-128ASL-M

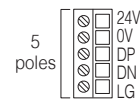

FX3U-32DP

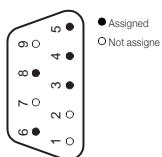

Pin No.	Signal name	Description
3	RXD/TXD-P	Receive/send data-P
4	RTS	Ready to send
5	DGND	Data ground
6	VP	Voltage+
8	RXD/TXD-N	Receive/send data-N
1, 2, 7, 9	NC	Not assigned

Terminal arrangement

◇ Type system (CPU module, input/output extension device)

(1)	CPU category	FX5U, FX5UC, etc.		Model system							
(2)	Type category	C (Extension connector type) None (Extension cable type)									
(3)	Total number of input/output points	8, 16, 32, 40, 64, 80, 96, etc.									
(4)	Module category	M	CPU module	FX5 - C 32 M R /ES - □	(1)	(2)	(3)	(4)	(5)	(6)	(7)
		E	Extension devices including both input and output devices								
		EX	Input extension module								
		EY	Output extension module								
(5)	Output type	R	Relay output								
		T	Transistor output								
(6)	Power supply, input/output system	Symbol	Power supply	Input type	Transistor output type	Input type	Transistor output type				
		/ES	AC	24 V DC, sink/source	sink	sink/source	—				
		/ESS	AC	24 V DC, sink/source	source	—	source				
		/DS	DC	24 V DC, sink/source	sink	sink/source	—				
		/DSS	DC	24 V DC, sink/source	source	—	source				
		/D	DC	24 V DC, sink	sink	sink	sink	sink			
(7)	Other suffix symbols	-H	High-speed input/output function expansion								
		-TS	Spring clamp terminal block								

◇ Input signal format

- When a contactless sensor output is connected to PLC, PNP open collector transistor output can be handled via source input wiring, and NPN open collector transistor output via sink input wiring.
- S/S terminal and 0 V terminal are short-circuited by source input wiring. (Left side of the drawing below)
S/S terminal and 24 V terminal are short-circuited by sink input wiring. (Right side of the drawing below)

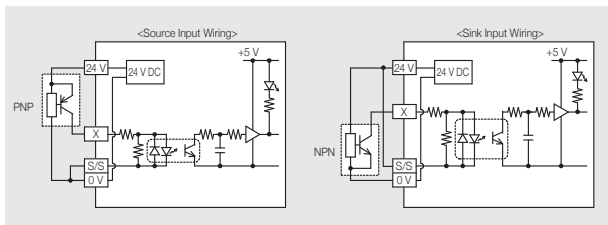

◇ Output signal format

- Relay output type is mechanically isolated by a relay, while transistor output type is isolated by a photocoupler. In addition, LED for output indication is driven by internal power supply.
- Transistor output is made up of NPN open collector output (sink [-common]) system and NPN emitter follower output (source [+common]) system.

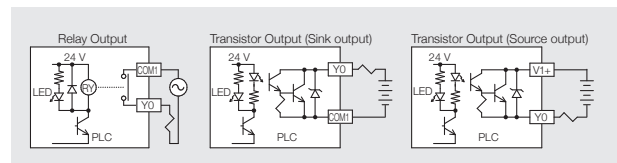

Products list

◇ CPU module

Model	Specifications				Description page			
	Rated voltage		Input	Output				
◆ FX5U CPU modules								
FX5U-32MR/ES	100 to 240 V AC 50/60 Hz	16 points	24 V DC sink/source	16 points	Relay	44		
FX5U-32MT/ES					Transistor/sink	44		
FX5U-32MT/ESS					Transistor/source	44		
FX5U-64MR/ES		32 points		24 V DC sink/source	32 points	Relay	44	
FX5U-64MT/ES						Transistor/sink	44	
FX5U-64MT/ESS						Transistor/source	44	
FX5U-80MR/ES		40 points			24 V DC sink/source	40 points	Relay	44
FX5U-80MT/ES							Transistor/sink	44
FX5U-80MT/ESS							Transistor/source	44
◆ FX5UC CPU modules								
FX5UC-32MT/D	24 V DC	16 points	24 V DC sink			16 points	Transistor/sink	51
FX5UC-32MT/DSS			24 V DC sink/source				Transistor/source	51
FX5UC-32MT/DS-TS			24 V DC sink/source	Transistor/sink			51	
FX5UC-32MT/DSS-TS		16 points	24 V DC sink/source	16 points		Transistor/source	51	
FX5UC-32MR/DS-TS						24 V DC sink	Relay	51
FX5UC-64MT/D					24 V DC sink	Transistor/sink	51	
FX5UC-64MT/DSS		32 points		24 V DC sink/source	32 points	Transistor/source	51	
FX5UC-96MT/D						24 V DC sink	Transistor/sink	51
FX5UC-96MT/DSS						24 V DC sink/source	Transistor/source	51
FX5UC-96MT/D	48 points	24 V DC sink/source			48 points	Transistor/sink	51	
FX5UC-96MT/DSS						24 V DC sink/source	Transistor/source	51

Products list

◇ I/O module

Model	Specifications				Description page	
	Rated voltage	Input	Output			
■■■ Extension cable type ■■■						
◆ Input module						
FX5-8EX/ES	Supplied from CPU module	8 points	24 V DC sink/source	—	—	58
FX5-16EX/ES		16 points		—	—	58
◆ Output module						
FX5-8EYR/ES	Supplied from CPU module	—	—	8 points	Relay	58
FX5-8EYT/ES					Transistor/sink	58
FX5-8EYT/ESS					Transistor/source	58
FX5-16EYR/ES		—	—	16 points	Relay	58
FX5-16EYT/ES					Transistor/sink	58
FX5-16EYT/ESS					Transistor/source	58
◆ Input/output module						
FX5-16ER/ES	Supplied from CPU module	8 points	24 V DC sink/source	8 points	Relay	58
FX5-16ET/ES					Transistor/sink	58
FX5-16ET/ESS					Transistor/source	58
◆ High-speed pulse input/output module						
FX5-16ET/ES-H	Supplied from CPU module	8 points	24 V DC sink/source	8 points	Transistor/sink	59
FX5-16ET/ESS-H					Transistor/source	59
◆ Powered input/output module						
FX5-32ER/ES	100 to 240 V AC 50/60 Hz	16 points	24 V DC sink/source	16 points	Relay	57
FX5-32ET/ES					Transistor/sink	57
FX5-32ET/ESS					Transistor/source	57
FX5-32ER/DS	24 V DC	16 points	24 V DC sink/source	16 points	Relay	57
FX5-32ET/DS					Transistor/sink	57
FX5-32ET/DSS					Transistor/source	57
■■■ Extension connector type ■■■						
◆ Input module						
FX5-C16EX/D	Supplied from CPU module	16 points	24 V DC sink	—	—	59
FX5-C16EX/DS			24 V DC sink/source			59
FX5-C32EX/D		32 points	24 V DC sink	—	—	59
FX5-C32EX/DS			24 V DC sink/source			59
FX5-C32EX/DS-TS			24 V DC sink/source			59
◆ Output module						
FX5-C16EYT/D	Supplied from CPU module	—	—	16 points	Transistor/sink	59
FX5-C16EYT/DSS					Transistor/source	59
FX5-C16EYR/D-TS		—	—	16 points	Relay	59
FX5-C32EYT/D		—	—	32 points	Transistor/sink	59
FX5-C32EYT/DSS					Transistor/source	59
FX5-C32EYT/D-TS					Transistor/sink	59
FX5-C32EYT/DSS-TS	Transistor/source				59	
◆ Input/output module						
FX5-C32ET/D	Supplied from CPU module	16 points	24 V DC sink	16 points	Transistor/sink	59
FX5-C32ET/DSS			24 V DC sink/source		59	
FX5-C32ET/DS-TS			24 V DC sink/source		59	
FX5-C32ET/DSS-TS			24 V DC sink/source		59	

◇ Expansion boards & Expansion adapter

Model	Specifications	Description page
FX5-232-BD	For RS-232C communication	108
FX5-485-BD	For RS-485 communication	108
FX5-422-BD-GOT	For GOT connection RS-422 communication	109
FX5-232ADP	For RS-232C communication	109
FX5-485ADP	For RS-485 communication	110
FX5-4AD-ADP	4 ch analog input adapter	67
FX5-4AD-PT-ADP	4 ch temperature sensor (resistance temperature detector) input	72
FX5-4AD-TC-ADP	4 ch temperature sensor (thermocouple) input	73
FX5-4DA-ADP	4 ch analog output adapter	67

◇ FX5 extension power supply module, bus conversion module, connector conversion module

Model	Specifications	Description page
FX5-1PSU-5V	FX5U (AC power supply type) extension power supply	124
FX5-C1PS-5V	FX5U (DC power supply type)/ FX5UC extension power supply	125
FX5-CNV-BUS	Bus conversion FX5 (extension cable type) → FX3	124
FX5-CNV-BUSC	Bus conversion FX5 (extension connector type) → FX3	124
FX5-CNV-IF	Connector conversion FX5 (extension cable type) → FX5 (extension connector type)	125
FX5-CNV-IFC	Connector conversion FX5 (extension connector type) → FX5 (extension cable type)	125

◇ FX5 intelligent function module

Model	Specifications	Description page
FX5-4AD	4 ch analog input	68
FX5-4DA	4 ch analog output	69
FX5-8AD	8 ch multi input	68
FX5-4LC	4 ch temperature control	75
FX5-20PG-P	2-axis pulse train positioning (transistor output)	87
FX5-20PG-D	2-axis pulse train positioning (differential driver output)	87
FX5-40SSC-S	Simple motion 4-axis control	89
FX5-80SSC-S	Simple motion 8-axis control	89
FX5-ENET	Ethernet module	101
FX5-ENET/IP	EtherNet/IP module	102
FX5-CCL-MS	CC-Link system master/intelligent device station	97
FX5-CCLIEF	Intelligent device station for CC-Link IE Field network	96
FX5-ASL-M	AnyWireASLINK system master module	104
FX5-DP-M	PROFIBUS-DP master module	107

◇ FX3 extension power supply module

Model	Specifications	Description page
FX3U-1PSU-5V	FX3 extension power supply	125

◇ FX3 intelligent function module

Model	Specifications	Description page
FX3U-4AD	4 ch analog input	69
FX3U-4DA	4 ch analog output	70
FX3U-4LC	4 ch temperature control	76
FX3U-1PG	Positioning pulse output 200 kpps	88
FX3U-2HC	2 ch 200 kHz high-speed counter	80
FX3U-16CCL-M	Master for CC-Link V2	98
FX3U-64CCL	Interface for CC-Link V2	99
FX3U-128ASL-M	Master for AnyWireALSINK system	105
FX3U-32DP	PROFIBUS-DP slave	107

◇ Software package

Type	Model	Specifications	Description page
MELSOFT iQ Works (DVD-ROM)	SW2DND-IQWK-E*1	FA engineering software (English version)*2	119
MELSOFT GX Works3 (DVD-ROM)	SW1DND-GXW3-E	PLC engineering software*2 (English version bundled product: GX Works 2, with GX Developer included)	120
MX Component	SW4DNC-ACT-E	ActiveX library for communication	120
MX Sheet	SW2DNC-SHEET-E	Microsoft® Excel® communication support tool	120
MX Works	SW2DNC-SHEETSET-E	A set of MX Component and MX Sheet	120

- *1: If you have a conventional model (SW1DND-IQWK-E), you cannot update.
Please purchase an upgraded version separately.
For details, please contact our sales representative.
- *2: For the corresponding models of each software, please refer to the manual of each product.

◇ Communication cable

Model	Specifications	Description page
FX-232CAB-1	3 m 9-pin D-sub (female) ↔ 9-pin D-sub (female) (for DOS/V, etc.)	116

◇ Input/output cable

Model	Specifications	Description page	
FX-16E-150CAB	1.5 m	For connection between terminal module and FX5 PLC (Flat cable with connectors at both ends)	
FX-16E-300CAB	3.0 m		
FX-16E-500CAB	5.0 m		
FX-16E-500CAB-S	5.0 m	Loose wire with connector on one end	128
FX-16E-150CAB-R	1.5 m	For connection between terminal module and FX5 PLC (Multi-core round cable with connectors at both ends)	
FX-16E-300CAB-R	3.0 m		
FX-16E-500CAB-R	5.0 m		

◇ Input/output connector

Model	Specifications	Description page
FX2C-I/O-CON	20-pin connector and 10 pressure connectors for flat cable	128
FX2C-I/O-CON-S	20-pin connector and 5 sets of housing for loose wire and crimp contact (for 0.3 mm ²)	128
FX2C-I/O-CON-SA	20-pin connector and 5 sets of housing for loose wire and crimp contact (for 0.5 mm ²)	128
A6CON1	40-pin connector, soldered type for external device connection (straight protrusion)	128
A6CON2	40-pin connector, crimped type for external device connection (straight protrusion)	128
A6CON4	40-pin connector, soldered type for external device connection (both straight/inclined protrusion type)	128
FX-I/O-CON2-S	40-pin connector, 2 sets for discrete wire, AWG22 (0.3 mm ²)	128
FX-I/O-CON2-SA	40-pin connector, 2 sets for discrete wire, AWG20 (0.5 mm ²)	128

◇ Terminal module

Model	Specifications	Description page
FX-16E-TB	16 input or output points	127
FX-32E-TB	32 input or output points	127
FX-16E-TB/UL	16 input or output points	127
FX-32E-TB/UL	32 input or output points	127
FX-16EYR-TB	16 relay output points 2 A/1 point (8 A/4 points)	127
FX-16EYS-TB	16 triac output points, 0.3 A/1 point (0.8 A/4 points)	127
FX-16EYT-TB	16 transistor output points, 0.5 A/1 point (0.8 A/4 points) (sink output)	127
FX-16EYR-ES-TB/UL	16 relay output points 2 A/1 point (8 A/4 points)	127
FX-16EYS-ES-TB/UL	16 triac output points, 0.3 A/1 point (0.8 A/4 points)	127
FX-16EYT-ES-TB/UL	16 transistor output points, 0.5 A/1 point (0.8 A/4 points) (sink output)	127
FX-16EYT-ESS-TB/UL	16 transistor output points, 0.5 A/1 point (0.8 A/4 points) (source output)	127

◇ Power cable

Model	Specifications	Description page
FX2NC-100MPCB	FX5UC CPU module, for 24 V DC power supply	129
FX2NC-100BPCB	Extension module (extension connector type), for 24 V DC input power supply	129
FX2NC-10BPCB1	Extension module (extension connector type), for 24 V DC input power supply connection wiring	129

◇ Extended cable/connector conversion adapter

Model	Specifications	Description page	
FX5-30EC	30 cm	For the extension of FX5 extension module	126
FX5-65EC	65 cm		126
FX5-CNV-BC	For the connection between an extended extension cable and an FX5 input/output module (extension cable type), a high-speed pulse input/output module, or an FX5 intelligent function module		126

◇ SD memory card & battery

Model	Specifications	Description page
NZ1MEM-2GBSD	SD memory card (2 GB)	123
NZ1MEM-4GBSD	SDHC memory card (4 GB)	123
NZ1MEM-8GBSD	SDHC memory card (8 GB)	123
NZ1MEM-16GBSD	SDHC memory card (16 GB)	123
FX3U-32BL	Battery	123

memo

Global FA Center

Mitsubishi Electric Corporation FA Centers support all our customers and users of MELSEC iQ-F Series all over the world.

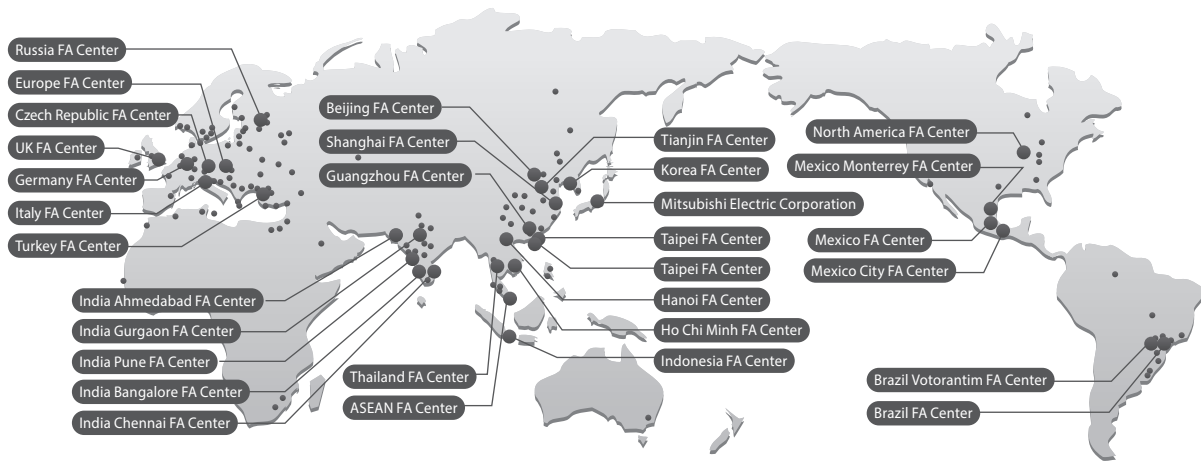

Japan (Tokyo)	FA Global Solution Technical Department	(TEL:+81-3-3218-6422)
Japan (Tokyo)	Asian Business Development Department	(TEL:+81-3-3218-6284)
China (Shanghai)	Mitsubishi Electric Automation (China) Ltd. Shanghai FA Center	(TEL:+86-21-2322-3030)
China (Beijing)	Mitsubishi Electric Automation (China) Ltd. Beijing Branch Beijing FA Center	(TEL:+86-10-6518-8830)
China (Tianjin)	Mitsubishi Electric Automation (China) Ltd. Tianjin Branch Tianjin FA Center	(TEL:+86-22-2813-1015)
China (Guangzhou)	Mitsubishi Electric Automation (China) Ltd. Guangzhou Branch Guangzhou FA Center	(TEL:+86-20-8923-6730)
Taiwan (Taichung)	Mitsubishi Electric Taiwan Co., Ltd.	(TEL:+886-4-2359-0688)
Taiwan (Taipei)	Setsuyo Enterprise Co., Ltd.	(TEL:+886-2-2299-9917)
Korea	Mitsubishi Electric Automation Korea Co., Ltd.	(TEL:+82-2-3660-9632)
ASEAN	MITSUBISHI ELECTRIC ASIA PTE. LTD.	(TEL:+65-6470-2480)
Indonesia	PT. Mitsubishi Electric Indonesia Cikarang Office	(TEL:+62-21-2961-7797)
Vietnam (Hanoi)	Mitsubishi Electric Vietnam Company Limited Hanoi Branch Office	(TEL:+84-4-3937-8075)
Vietnam (Ho Chi Minh)	Mitsubishi Electric Vietnam Company Limited	(TEL:+84-9-3910-5945)
Thailand	Mitsubishi Electric Factory Automation (Thailand) Co., Ltd.	(TEL:+66-2682-6522)
India (Pune)	Mitsubishi Electric India Pvt. Ltd. Pune Branch	(TEL:+91-20-2710-2000)
India (Gurgaon)	Mitsubishi Electric India Pvt. Ltd. Gurgaon Head Office	(TEL:+91-124-463-0300)

India (Bangalore)	Mitsubishi Electric India Pvt. Ltd. Bangalore Branch	(TEL:+91-80-4020-1600)
India (Chennai)	Mitsubishi Electric India Pvt. Ltd. Chennai Branch	(TEL:+91-44-4554-8772)
India (Ahmedabad)	Mitsubishi Electric India Pvt. Ltd. Ahmedabad Branch	(TEL:+91-79-6512-0063)
North America	Mitsubishi Electric Automation, Inc.	(TEL:+1-847-478-2469)
Mexico	Mitsubishi Electric Automation, Inc. Queretaro Office	(TEL:+52-442-153-6014)
Mexico (Mexico City)	Mitsubishi Electric Automation, Inc. Mexico Branch	(TEL:+52-55-3067-7511)
Mexico (Monterrey)	Mitsubishi Electric Automation, Inc. Monterrey Office	(TEL:+52-55-3067-7521)
Brazil	Mitsubishi Electric do Brasil Comércio e Serviços Ltda.	(TEL:+55-11-4689-3000)
Brazil (Votorantim)	MELCO CNC do Brasil Comercio e Servicos S.A.	(TEL:+55-15-3023-9000)
Europe	Mitsubishi Electric Europe B.V. Polish Branch	(TEL:+48-12-347-65-00)
Germany	Mitsubishi Electric Europe B.V. German Branch	(TEL:+49-2102-486-0)
UK	Mitsubishi Electric Europe B.V. UK Branch	(TEL:+44-1707-27-8780)
Czech Republic	Mitsubishi Electric Europe B.V. Czech Branch	(TEL:+420-255-719-200)
Italy	Mitsubishi Electric Europe B.V. Italian Branch	(TEL:+39-039-60531)
Russia	Mitsubishi Electric (Russia) LLC St. Petersburg Branch	(TEL:+7-812-633-3497)
Turkey	Mitsubishi Electric Turkey A.S. Umraniye Branch	(TEL:+90-216-526-3990)

About this product catalog

Due to the constantly growing product range and new or changed product features, the information in this catalog may be updated without notice. Please contact your Mitsubishi Electric product provider for more details.

Texts, figures and diagrams shown in this product catalog are intended exclusively for explanation and assistance in planning and ordering the FX5 programmable logic controllers (PLCs) and the associated accessories. Only the manuals supplied with the modules are relevant for installation, commissioning and handling of the modules and the accessories. The information given in the manuals must be read before installation and commissioning of the

modules or software.

If any questions arise regarding the application or use of the PLC modules and accessories described in this catalog, please contact your Mitsubishi Electric product provider.

This catalog confers no industrial property rights or any rights of any other kind, nor does it confer any patent licenses. Mitsubishi Electric Corporation cannot be held responsible for any problems involving industrial property rights which may occur as a result of using the contents noted in this catalog.

©2017 MITSUBISHI ELECTRIC CORPORATION

- Anywire and AnyWireASLINK are either registered trademarks or trademarks of Anywire Corporation.
- Ethernet is a trademark of Xerox Corporation.
- QR Code is either a registered trademark or a trademark of DENSO WAVE INCORPORATED in the United States, Japan, and/or other countries.
- Microsoft, Microsoft Access, Excel, SQL Server, Visual Basic, Visual C++, Visual Studio, Windows, Windows NT, Windows Server, Windows Vista, and Windows XP are either registered trademarks or trademarks of Microsoft Corporation in the United States and/or other countries.
- Celeron, Intel, and Pentium are either registered trademarks or trademarks of Intel Corporation in the United States and/or other countries.
- The SD and SDHC logos are trademarks of SD-3C, LLC.
- The company names, system names and product names mentioned in this document are either registered trademarks or trademarks of their respective companies.
- In some cases, trademark symbols such as TM or [®] are not specified in this document.

YOUR SOLUTION PARTNER

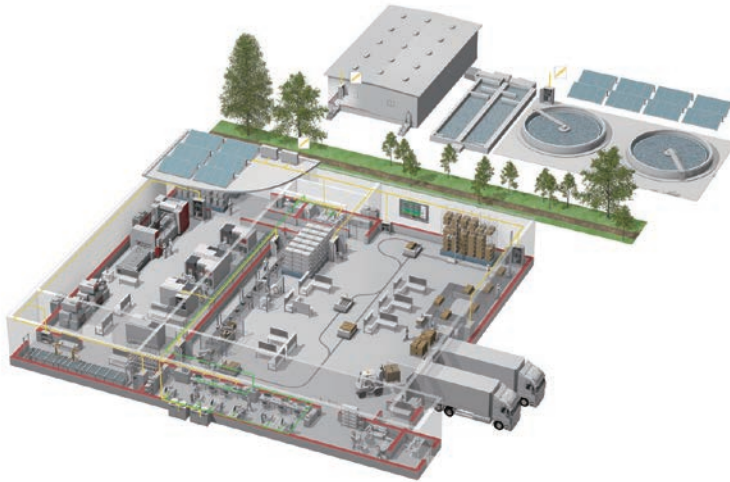

Mitsubishi Electric offers a wide range of automation equipment from PLCs and HMIs to CNC and EDM machines.

A NAME TO TRUST

Since its beginnings in 1870, some 45 companies use the Mitsubishi name, covering a spectrum of finance, commerce and industry.

The Mitsubishi brand name is recognized around the world as a symbol of premium quality.

Mitsubishi Electric Corporation is active in space development, transportation, semi-conductors, energy systems, communications and information processing, audio visual equipment and home electronics, building and energy management and automation systems, and has 237 factories and laboratories worldwide in over 121 countries.

This is why you can rely on Mitsubishi Electric automation solution - because we know first hand about the need for reliable, efficient, easy-to-use automation and control in our own factories.

As one of the world's leading companies with a global turnover of over 4 trillion Yen (over \$40 billion), employing over 100,000 people, Mitsubishi Electric has the resource and the commitment to deliver the ultimate in service and support as well as the best products.



Low voltage: MCCB, MCB, ACB



Medium voltage: VCB, VCC



Power monitoring, energy management



Compact and Modular Controllers



Inverters, Servos and Motors



Visualisation: HMIs



Numerical Control (NC)



Robots: SCARA, Articulated arm



Processing machines: EDM, Lasers, IDS



Transformers, Air conditioning, Photovoltaic systems

* Not all products are available in all countries.

PROGRAMMABLE CONTROLLERS
MELSEC iQ-F Series

mitsubishi **ELECTRIC CORPORATION**

HEAD OFFICE: TOKYO BLDG., 2-7-3, MARUNOUCHI, CHIYODA-KU, TOKYO 100-8310, JAPAN
www.MitsubishiElectric.com
